

electronics

radio, communication, industrial applications of electron tubes . . . engineering and manufacture



MAIN LIBRARY
REFERENCE
2nd. FLOOR

OCT 17 '40



TELEVISION CHANGEOVER

Empire State radiator during alterations (see pages 24 and 25)

**OCTOBER
1940**

Price
50 Cents

McGRAW-HILL
PUBLISHING
COMPANY, INC.



AMPEREX

HF 3000 • ZB 3200

A Preferred Combination for 5 KW Broadcast Transmitters

Broadcast engineers and transmitter designers are favoring AMPEREX HF3000's and ZB3200's over combinations of other Forced Air Cooled tubes because of the lower initial cost of these tubes and their associated equipment and the simplification of transmitter design made possible through their use.

The inherent distortion minimizing characteristics of the HF3000 makes it the preferred tube for plate modulation service.

The ZB3200 with its low driving power requirement and the many advantages that its Zero Bias characteristics offer makes this tube a natural complement to the HF3000.

Engineering information and operational data for both of the above tubes will be mailed on request.

PRICE \$300

AMPEREX ELECTRONIC PRODUCTS, Inc.

79 WASHINGTON STREET

BROOKLYN, NEW YORK

electronics

A McGRAW-HILL

PUBLICATION

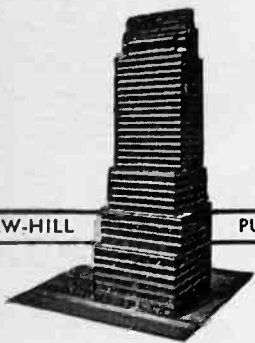

KEITH HENNEY

Editor

Donald G. Fink
Managing Editor

Beverly Dudley Craig Walsh
Associate Editor Assistant Editor

M. L. Matthey J. M. Heron
Assistant Editor Assistant Editor

Harry Phillips
Art Director

H. M. MATEER

Manager

Wallace B. Blood
Sales Manager

Contents Copyright, 1940, by
McGraw-Hill Publishing Company, Inc.

McGRAW-HILL
PUBLISHING COMPANY, INC.

JAMES H. MCGRAW
Founder and Honorary Chairman

Publication Office
99-129 North Broadway, Albany, N. Y.
U. S. A.

Editorial and Executive Offices
330 West 42nd St., New York, N. Y., U.S.A.

James H. McGraw, Jr., President
Howard Ehrlich, Executive Vice President
Mason Britton, Vice Chairman

B. R. Putnam, Treasurer
D. C. McGraw, Secretary
J. E. Blackburn, Jr., Director of Circulation

Cable Address:
MCGRAWHILL, New York
Member A. B. P. Member A. B. C.

CONTENTS—OCTOBER, 1940

EMPIRE STATE CHANGEOVER.....Cover

Photographed from the world's highest "solid ground", this view of the television radiator of the National Broadcasting Company, atop the Empire State Building, New York, was taken shortly after the sound-signal elements were removed for conversion from 49.75 to 55.75 Mc. This and the pictures shown on pages 24 and 25 were photographed by Tom Carew, McGraw-Hill Photographic Service

TUBES IN THE BRISTOL-MYERS PLANT,

by **Craig Walsh**..... 16

A survey of electronic applications in a plant where tubes are widely used for control and supervisory purposes

VERTICAL VS HORIZONTAL POLARIZATION,

by **G. H. Brown**..... 20

A topic of great interest in television and f-m standardization. Measurements indicate advantage of horizontal polarization for broadcast services

EMPIRE STATE TELEVISION STATION CHANGES FREQUENCY 24

Pictures showing the many jobs involved in shifting W2XBS from the 44-50 Mc channel to the 50-56 Mc channel

DESIGN AND APPLICATION OF X-RAY TUBES,

by **Z. J. ATLEE**..... 26

An up-to-date review of the types of x-ray tubes and their special fields of use

COAST GUARD EMERGENCY TRUCK..... 31

A radio-equipped mobile unit ready for flood service, fire-fighting, ambulance work and weather reporting

COLOR TELEVISION DEMONSTRATED BY CBS ENGINEERS.... 32

Application of rotating filter discs produces 343-line images on standard television channel

PROGRAM OF THE 1940 ROCHESTER FALL MEETING..... 35

Papers to be delivered to the I.R.E.-R.M.A. assembly

AN ELECTRONIC METHOD OF MEASURING DISTRIBUTION,

by **L. A. Ware**..... 36

A combination of a rotating commutator and thyratron counter to indicate numerical distribution

HIGH-VOLTAGE SUPPLY INDICATOR,

by **R. L. Hildebrand**..... 38

A supervisory alarm for high voltage systems used in dust precipitation equipment

FILTER DESIGN CHARTS, II,

by **John Borst**..... 39

Graphical determination of elements of m-derived sections, including low-pass, high-pass, and band elimination types

DEPARTMENTS

CROSSTALK	15	TUBES	65
REFERENCE SHEET	39	THE ELECTRON ART	75
BOOKS	42	THE INDUSTRY IN REVIEW	84
TUBES AT WORK	44	INDEX TO ADVERTISERS	96

ELECTRONICS, October, 1940, Vol. 13, No. 10. Published monthly, price 50c a copy. Allow at least ten days for change of address. All communications about subscriptions should be addressed to the Director of Circulation, 330 West 42nd Street, New York, N. Y.

Subscription rates—United States and possessions, Canada, Mexico and Central American countries, \$5.00 a year, \$8.00 for two years, \$10.00 for three years. Great Britain and British Possessions 36 shillings for one year, 72 shillings for three years. All other countries \$6.00 for one year, \$12.00 for three years. Entered as Second Class matter, August 29, 1936, at Post Office, Albany, New York, under the Act of March 3, 1879. BRANCH OFFICES: 520 North Michigan Avenue, Chicago; 68 Post Street, San Francisco; Aldwych House, Aldwych, London, W.C. 2; Washington; Philadelphia; Cleveland; Detroit; St. Louis; Boston; Atlanta, Ga.

START OUT ON TOP STAY ON TOP

with

General
Electric

FM

Broadcast
Transmitters

G-E'S FULL dynamic range, amazing frequency response, and low harmonic distortion promise to every listener the complete thrill of FM.

Broadcasters find almost unbelievable the complete accessibility of all parts and tubes . . . the ease with which detailed inspection can be made *without disassembly*. Floor space requirements of G-E transmitters are surprisingly small; all units are self-contained; installation is no problem at all.

Every G-E transmitter is thoroughly inspected and tested before it leaves the factory. Square-wave measurements, cross-modulation checks, noise-level tests, linearity measurements—from every angle performance is *proved* before a unit is allowed to go into service.

Continuity of Service

Automatic reclosing devices to restore service after temporary overloads, plus complete accessibility of parts and tubes, make service continuity no object of concern to G-E users.

Instant-acting Electronic Frequency Control

Any tendency toward center-frequency drift is instantly corrected in all G-E FM transmitters by constant electronic comparison of output frequency with a precision crystal frequency. ONLY FOUR TUBES are used in the stabilizing circuit. There are no moving parts.

The low temperature-coefficient crystal is mounted in a hermetically sealed G-E Thermocell. Stability is better than ± 1000 cycles (100% better than FCC requirements) over a normal room temperature range.

True High Fidelity

Excellent frequency response (flat within 1 db from 30 to 16,000 cycles) and low harmonic distortion (less than 1½% from 30 to 7,500 cycles) mean full realization of FM's capabilities.

Full Dynamic Range

With noise level down 70 db from the 100% modulation level, all the brilliance and naturalness of even a full symphony reaches the receiver undiminished. G-E transmitters now in service are known for their exceptional fidelity.

Ease of Installation

Each unit of the G-E line is completely self-contained and sturdily built. Extremely small floor space is required. Installation is simple.

Ease of operation

G-E research has simplified circuit design—eliminated trick, hard-to-adjust circuits. No special training is required in operating procedure. Frequent critical retuning or adjusting is not necessary. Control circuits, too, are unusually simple.

Low Maintenance Expense

G-E's small tube complement, unusual accessibility for routine inspections, and conservative operation of all components make for big savings in upkeep. Efficient operation keeps power cost down.

Smart Styling

Smooth, flowing lines give striking appearance to a thoroughly practical design. Ray Patten, leading industrial designer, is responsible for the styling.

USE G-E TRANSMITTING TUBES

Since 1913, G.E. has been designing and building radio tubes for all services . . . on land and sea, and in the air. G-E tubes have been extensively used by the U.S. Government for years.

Give G-E tubes a chance to show you really superior performance. Place your next order through our local representative.



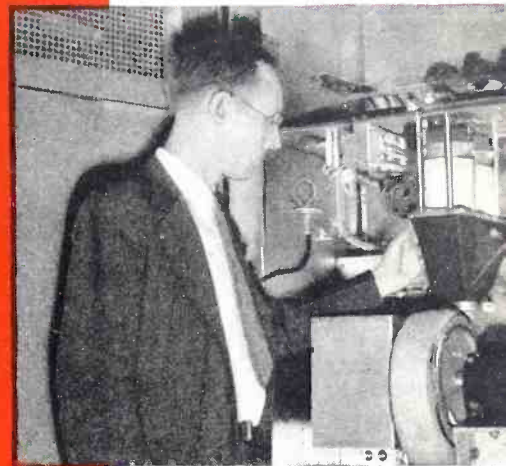
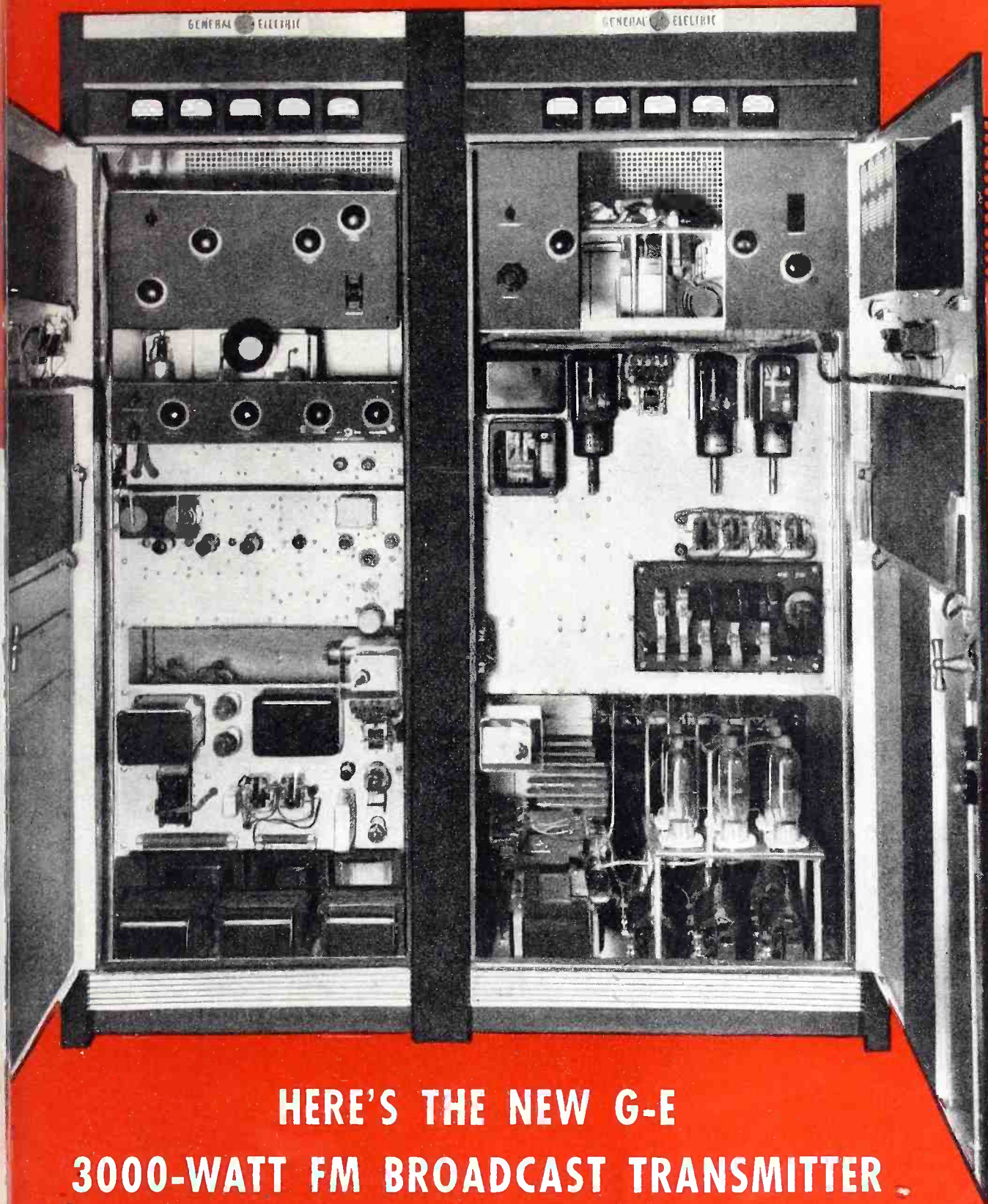

Quiet, compact, efficient this cooling system adequately supplies the requirements of both GL-8002-R's. The blower and filter are rubber-mounted inside the amplifier cabinet.

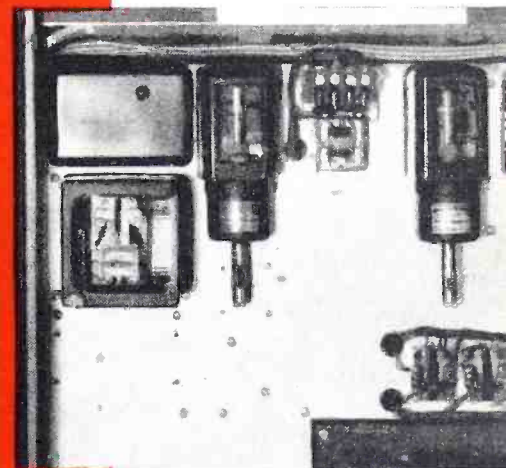

Overload relays protect against both a-c and d-c overloads; automatic reclosers restore service instantly. No lost time here!



The tiny GL-8002-R used in the 3000-watt FM transmitter was specially designed by G-E engineers for ultra-high-frequency application. It has a center-tapped filament and three grid-leads. Output: 1800 watts up to 120 mc.

HERE'S THE NEW G-E 3000-WATT FM BROADCAST TRANSMITTER

Consisting of a standard 250-watt transmitter (as exciter) and a 3000-watt push-pull neutralized amplifier (completely self-contained), the G-E 3000-watt transmitter strikes a new note in compactness and efficiency.

The amplifier uses two GL-8002-R forced-air-cooled triodes, with six GL-872-A's in the 3-phase rectifier. Total power consumption for the entire transmitter, including blower, is about 11 kw. Only 11.1 sq ft of floor space is required. Complete specifications are contained in bulletin GEA-3485. Ask for your copy. General Electric, Schenectady, New York.

G-E UNITS NOW IN OPERATION

W8XVH—Columbus, O.—250 watts

W9XYH—Superior, Wis.—250 watts

W1XTG—Worcester, Mass.—1000 watts

W2XOY—Schenectady, N. Y.—2500 watts*

Hinchenbrook Island, Alaska—two 250-watt units†

Ralston Island, Alaska—two 250-watt units†

*Operated experimentally since March 9, 1937

†Operated by Civil Aeronautics Administration

GENERAL ELECTRIC

AXIAL LEAD

RESISTORS

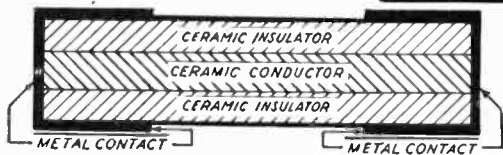

Magnified cross section showing the important and exclusive Centralab features:

Note center core of resistance material surrounded by a dense shock-proof ceramic providing strength and protection against humidity.

Both core and jacket are fired together at 2500 degrees F. into a solid unit . . . hard and durable as stone.

Pure copper covers the resistor ends for contact.

AXIAL LEAD RESISTORS

Completely insulated

Designed to fit into limited space without danger of shorting to the chassis or other parts. Same resistor bodies are used as in Radial Lead units, millions of which are now in use . . . only difference is in method of making end contact. End leads brought through bakelite insulation. Will withstand five times rated load without permanent change.

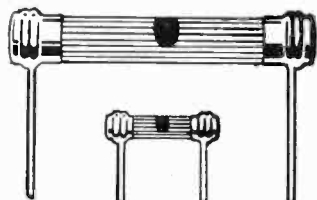

RADIAL LEAD RESISTORS

90% Insulated

The ceramic body of all Centralab resistors is in itself an insulator of the highest quality. Only the radial leads where attached to the body are un-insulated. Electrical characteristics of the Axial and Radial lead types are identical.



Old Man Centralab continues to score a bulls eye with the millions of Fixed Resistors that are doing duty in new and replacement jobs the country over. Manufacturers, experimenters, hams and service men continue to believe (and justly so) that Centralab's unique method of uniting the resistance material with the ceramic body makes for a resistor of unusual strength and efficiency under any and all conditions. Available in either Radial or Axial Lead . . . color coded (R.M.A.) in convenient sizes and ratings.

Always insist on CENTRALAB.

CENTRALAB: Division of Globe Union Inc., Milwaukee, Wis.

by
Centralab

"HAD TO RE-ADJUST FINAL AMPLIFIER COUPLING CIRCUITS BECAUSE OF LAPP CONDENSER'S LOW LOSS"

writes **L. W. STINSON, KVOO**



L. W. STINSON

"The two continuously variable 1000 mmf Lapp gas-filled condensers were originally ordered as part of a plan to change over our 50 kilowatt transmitter to a modern high-efficiency type of circuit. Plans did not call for an immediate changeover, so they were installed in the regular circuit to replace the solid dielectric condensers in use. For this temporary installation the variable capacitance feature was used only to adjust the unit to a fixed value with a radio frequency bridge; minor changes were made in the neutralizing circuits and the Lapp units inserted in the same position as the old bank of twelve mica capacitors.

"We had not anticipated that the increase of efficiency due to the gas-filled units would necessitate re-adjustment of the final amplifier coupling circuits but such was the case, as the increased impedance presented to the tube anodes raised the efficiency above optimum linear amplifier operating conditions. This of course, is a testimonial to the Lapp claim of 'low loss' features, and permitted us to transfer just that much more power to the antenna and to discard the air blower which had been found necessary to hold the temperature rise of the mica units to a safe value. As best we can determine, the gas-filled units operate at the ambient temperature.

"Our condensers, received in February, 1939, were filled to 200 pounds nitrogen shortly after arrival. Since then they have required absolutely no service of any kind."

Descriptive literature and list of 54 models in three voltage ratings available on request.

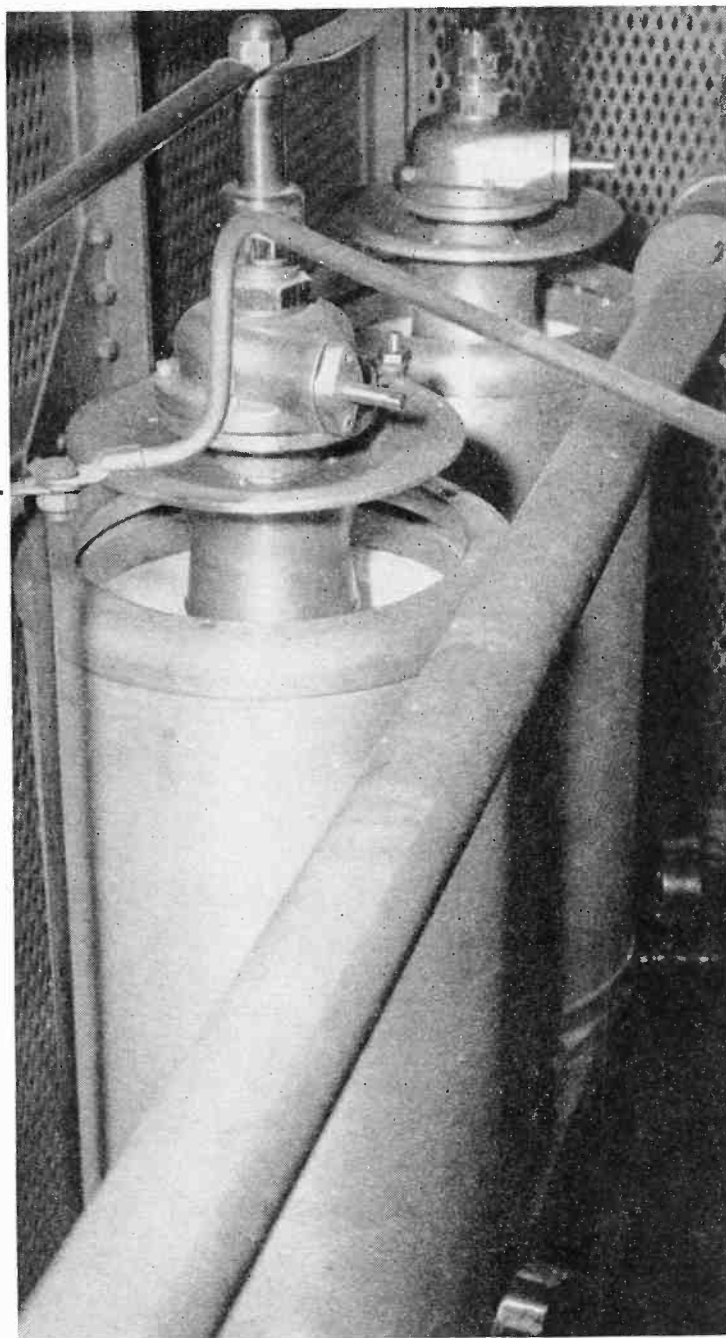
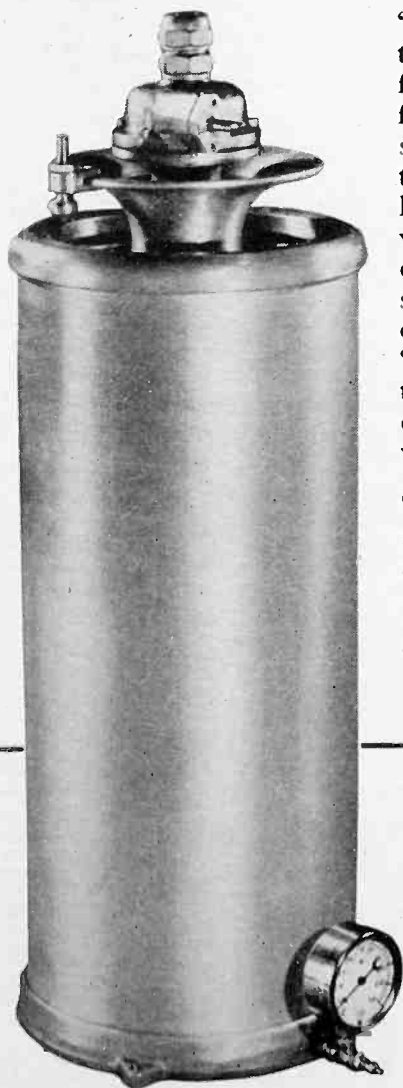

LAPP INSULATORS

LEROY, N. Y., U. S. A.

WHEN IT COMES TO LIGHTING "LUCITE" has the EDGE

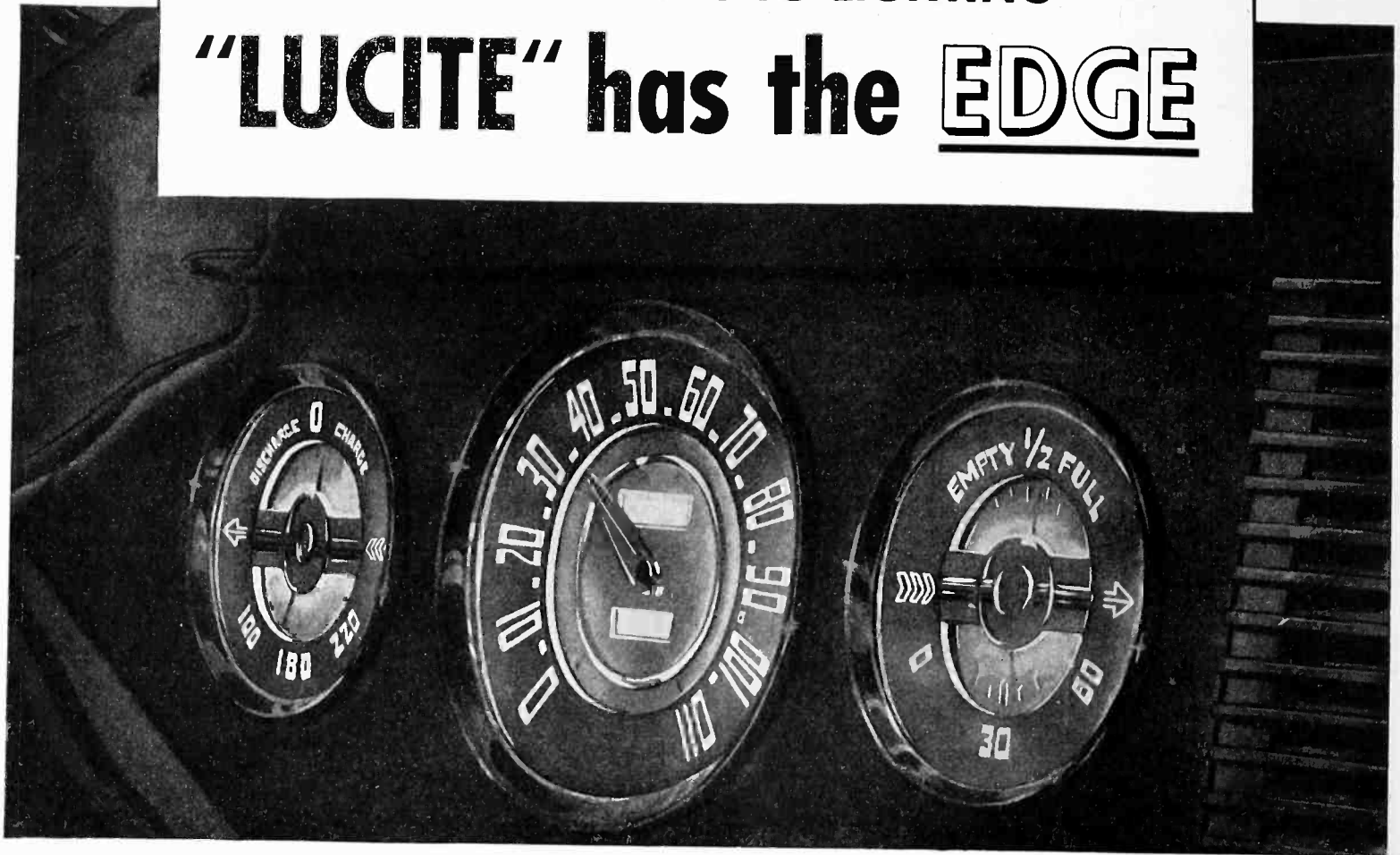

This plastic's ability to "pipe light" brings magic beauty to automobile instrument boards, radio panels, gas pump faces, and many other electrical products, through "edge lighting"

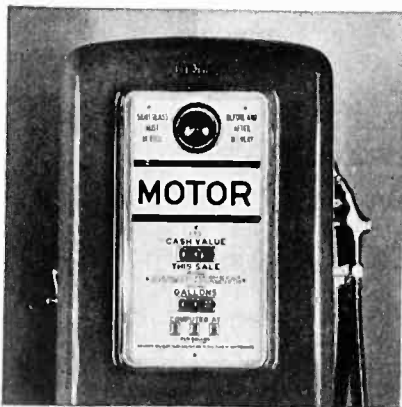

(above) With "edge lighting," a panel of "Lucite" gives enlarged and improved visibility to this gasoline pump face.

(below) An "edge lighted" panel of "Lucite" makes it easy to find the right station on this modern radio.



CARS that are all dressed up in "Lucite" for 1941 are the cars that will have places to go. Observe how this amazing plastic transforms instrument panels with the magic of "edge lighting." Then picture how it will do the same thing for your own products.

A polished sheet of "Lucite" has the ability to "pipe light" like a chain of mirrors. Light directed against one edge is carried throughout the piece by total reflection. When the surface is etched, it leaks out to produce a pleasing glow without glare or reflection. That is the basis of "edge lighting" . . . and in it you will find a new world of opportunities for decorative lighting effects.

But "edge lighting" is only one of the properties which recommend "Lucite" to electrical manufacturers. Weather-resistant, non-shatterable and a good insulator, "Lucite" may be easily molded for a variety of uses.

Applications in the electrical field include color caps for indicating lamps, button lenses for signs, aerial and antennae insulators, voltmeter housings, illuminated sign letters and policemen's traffic torches, illuminated surgical and industrial instruments, and rechargeable flashlight battery cases.

Here is a chart summarizing the properties of "Lucite." See if they won't help to better or beautify products of your own.

It's clear—with a beautiful soft lustre. In crystal form, it is practically invisible, transmitting a high percent-

age of light. In translucent colors its clarity gives unusual effects.

It's safe—because it's tough, practically unbreakable.

It's strong—with tensile strength 7,000 to 10,000 lbs. per sq. in. and flexural strength 10,000 to 12,000 lbs. per sq. in.

It's weather resistant—stable in clarity, color. Three-year service shows no apparent change.

It's chemically resistant—to dilute alcohols, alkalis and mineral salt solutions.

It has low heat conduction—resistant to heat or cold, it is pleasant to the touch.

It's light in weight—specific gravity 1.16 to 1.20.

It has high dielectric strength—

Dielectric constant: 60 cycles, 3.5 to 4.5

10⁶ cycles, 2.5 to 3.0

Power factor: 60 cycles, 0.06 to 0.08

10⁶ cycles, 0.01 to 0.03

It's easily molded—from highly accurate highway reflectors to intricate wet-cell batteries, it has helped solve scores of difficult jobs.

* * *

Du Pont has other plastics to help solve your design problems. And a technical service that's ready to answer any questions you may have. Write to E. I. du Pont de Nemours & Co. (Inc.), Plastics Dept., Arlington, N. J.

"Lucite" is Reg. U. S. Pat. Off.



96

PAGES OF VALUABLE DATA ON RESISTANCE PROBLEMS



OHMITE

RESISTORS • RHEOSTATS • TAP SWITCHES
CATALOG NO. 44



OHMITE MANUFACTURING COMPANY
CHICAGO, U.S.A.

New OHMITE Catalog and Manual

DESIGN and Application Engineers! . . . Laboratory Men! . . . Production Managers! . . . Purchasing Departments! . . . Here's a book that really works for you. The new Ohmite Catalog and Engineering Manual is different—it's a complete handy reference on resistance application problems. It contains useful reference tables, complete dimensional drawings, valuable engineering data and a manual of resistance measurements. It describes the most complete line of stock units and special units for Industrial, R. F., and Precision applications. It tells you how to select the right units for your needs. You'll find it an invaluable guide on the use of Resistors, Rheostats, Tap Switches, Chokes,

and Attenuators in electronic and radio equipment—in the control of motor speed, of heat and light, of signal and supervisory circuits—in products and machine tools—in laboratories, maintenance and production. You'll want it handy for ready reference—and you can have it without charge. Send for it now. Just clip this coupon to your letterhead or write us on company stationery.

OHMITE MANUFACTURING COMPANY
4816 Flournoy St., Chicago, U. S. A.
Please Send Catalog 40.

Company
 Individual
 Position
 Address
 City State

Be Right with **OHMITE**
RHEOSTATS • RESISTORS • TAP SWITCHES

EXCELLENT STABILITY

under extremes of heat and cold

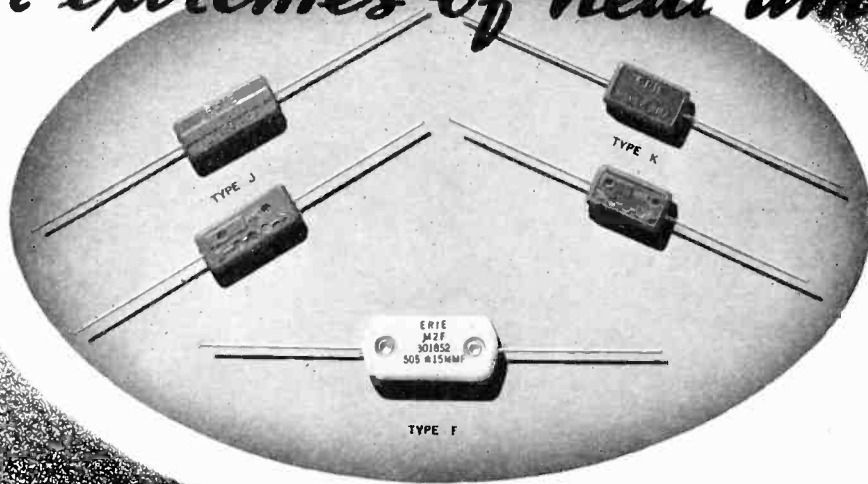

ERIE SILVER MICAS

**UNUSUALLY GOOD TEMPERATURE CHARACTERISTICS
MAKE POSSIBLE GREATER RECEIVER EFFICIENCY**

A MINUTE spent in reading the Erie Silver Mica Condenser test results given below will prove to you that these units are ideal for obtaining automatic tuning stability under all conditions of temperature. With Erie Silver Micras in your oscillator circuit, you can be certain that, regardless of temperatures encountered in shipping or in operation, frequency changes due to condenser capacity drift, will be extremely small.

GENERAL CHARACTERISTICS TYPE J ERIE SILVER MICA CONDENSERS

	Test Frequency 1000 Kc.
175 Units, 125 MMF.	
Average Power Factor.....	.026%
Maximum Power Factor.....	.032%
Average Temp. Coef. (x 10 ⁻⁶) per °C. (20° to 80° C.).....	38.8
Maximum Temp. Coef. (x 10 ⁻⁶) per °C. (20° to 80° C.).....	42.2

After 100 Complete Cycles of 15 min. at -75° F., 15 Min. at 200° F. And 15 Min. At Room Temperature

Average Power Factor.....	.032%
Average Capacity Change.....	-.179%
Greatest Capacity Change.....	-.31%

After 500 Hours in 100% Relative Humidity at 104° F.

Average Power Factor.....	.034%
Maximum Capacity Change.....	-.05%
Lowest Leakage Resistance (at 1000 Volts D.C.), Over 10,000 Megohms	

The above figures will vary slightly for different nominal capacities.

RESISTORS
SUPPRESSORS
CERAMICONS
SILVER-MICA
CONDENSERS

Erie RESISTOR CORPORATION, ERIE, PA.

TORONTO, CANADA • LONDON, ENGLAND • PARIS, FRANCE-J.E.CANETTI CO.

MOLDED BEZELS
PUSH BUTTONS
AND KNOBS
POLYSTYRENE
COIL FORMS

Versatile

VERSATILE AS TO SIZE • SHAPE • DESIGN



A WIDE VARIETY OF "BODIES" OF DIFFERENT PHYSICAL CHARACTERISTICS

AlSiMag

Custom-made Steatite
Ceramic parts are engineered for
YOUR application and shaped for YOUR product.

ALSiMAG

Trade Mark Reg. U. S. Pat. Off.

FROM CERAMIC HEADQUARTERS

AMERICAN LAVA CORPORATION • CHATTANOOGA • TENNESSEE

CHICAGO • CLEVELAND • NEW YORK • ST. LOUIS • LOS ANGELES • SAN FRANCISCO • BOSTON • PHILADELPHIA • WASHINGTON, D. C.

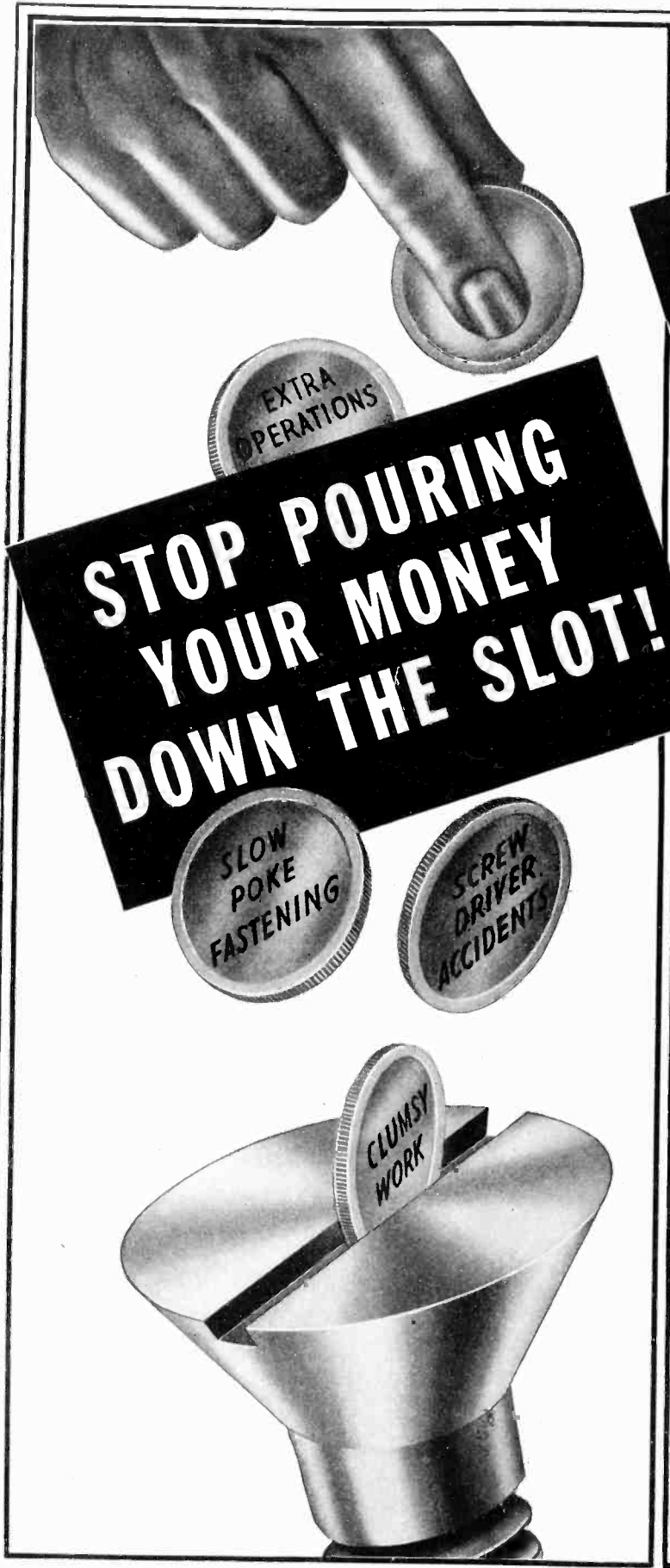

**PHILLIPS SCREWS
CUT OUT THE COSTS
THAT WASTE
ASSEMBLY MONEY**

Why
*continue to gamble
with slotted head screws?*

Here's what a changeover to Phillips Recessed Head Screws has accomplished for thousands of firms manufacturing aircraft, automobiles, electrical goods, furniture, plastics, etc.

- SAVED** the difference in time between using hand drivers and power drivers.
- SAVED** the cost of refinishing screw-driver scars.
- SAVED** money by using fewer screws or smaller (low-priced) sizes.
- SAVED** time wasted when screw heads split.

Phillips Screws give an additional bonus in a stronger job with more sales appeal. Users report an average saving of 50% with Phillips. Get full information from one of firms listed below.

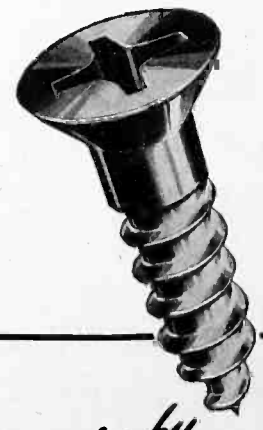

PHILLIPS RECESSED HEAD SCREWS...

- WOOD SCREWS • MACHINE SCREWS • SHEET METAL SCREWS • STOVE BOLTS
- SPECIAL THREAD-CUTTING SCREWS • SCREWS WITH LOCK WASHERS

U. S. Patents on Product and Methods Nos. 2,046,343; 2,046,837; 2,046,839; 2,046,840; 2,082,085; 2,084,078; 2,084,079; 2,090,338. Other Domestic and Foreign Patents Allowed and Pending.

American Screw Co., Licensor, Providence, R. I.
Continental Screw Co., New Bedford, Mass.
Corbin Screw Corporation, New Britain, Conn.

The Lamson & Sessions Co., Cleveland, Ohio
National Screw & Mfg. Co., Cleveland, Ohio
Parker-Kalon Corporation, New York, N. Y.
Pheoil Manufacturing Company, Chicago, Illinois

Russell, Burdshall & Ward Bolt & Nut Co., Port Chester, N. Y.
Scovill Manufacturing Co., Waterbury, Conn.
Shakeproof Lock Washer Co., Chicago, Ill.

*Speed Product Deliveries by
Cutting Assembly Time*

Difficult Measurements Are Easy

With These G-E Instruments

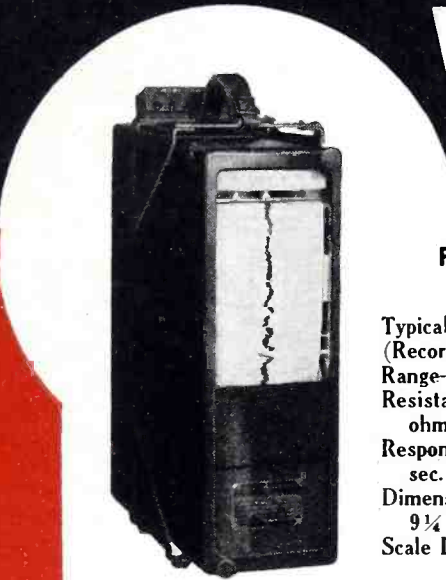

Photoelectric Recorders

Typical Characteristics
(Recording Galvanometer)
Range—0 to 1 microampere
Resistance—approx. 2280 ohms
Response Time—approx. 1 sec.
Dimensions—5½ by 16 by 9¼ in.
Scale Length—3¾ in.

TO RECORD ONE MICROAMPERE

These sensitive instruments can be used to record any quantity indicated by the movement of a tiny mirror. They are the most sensitive recorders known which do not employ electrical amplification of the quantity being measured.

They are very useful for recording values such as grid currents of vacuum tubes, small photo-tube currents, and small thermocouple voltages for low-temperature records. Measurements can also be telemetered.

Both portable and switchboard types are available.

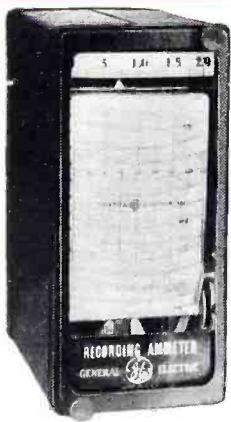

Direct-acting Recorders — Type CD

Typical Characteristics
(Milliammeter)
Range—0 to 2 milliampere
Resistance—approx. 1800 ohms
Response Time—approx. 2 sec.
Dimensions—5½ by 12 by 9⅞ in.
Scale Length—4 in.

TO RECORD ONE MILLIAMPERE

A new direct-current instrument in the Type CD line offers a convenient means for recording plate current and other small current values in lower ranges than were previously possible.

The chart is driven by a Telechron motor, thus assuring dependable operation. The instrument is lightweight, easy to use, and can be obtained in both portable and switchboard types.

This Type CD instrument is one of a complete line for recording current, voltage, watts, power-factor, and frequency.

TO RECORD MICROAMPERES

Here is a new line of direct-current INKLESS recorders—available in high-resistance voltmeters and low-resistance ammeters, milliammeters, and microammeters*. A-c voltmeters and ammeters are also available.

These low-cost instruments are well suited for electronics work because of their low power consumption. Exceptionally small and lightweight, they are readily portable. Provision is also made for wall mounting.

*The microammeters are available down to 125 microamperes, full scale.

New Inkless Recorder—Type CF

Typical Characteristics
(Milliammeter)
Range—0 to 1 milliampere
Resistance—approx. 16 ohms
Response Time—approx. 3 sec.
Dimensions—8⁹/₁₆ by 10⁹/₁₆ by 5³/₃₂ in.
Scale Length—3½ in.

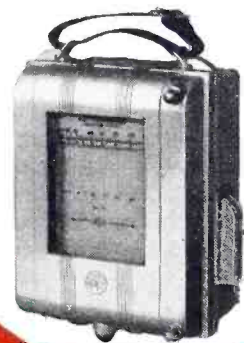

For further information about these or other instruments in the complete G-E line, call the nearest G-E office, or write General Electric Company, Schenectady, New York.

HEADQUARTERS FOR ELECTRICAL MEASUREMENT

GENERAL ELECTRIC

602-17

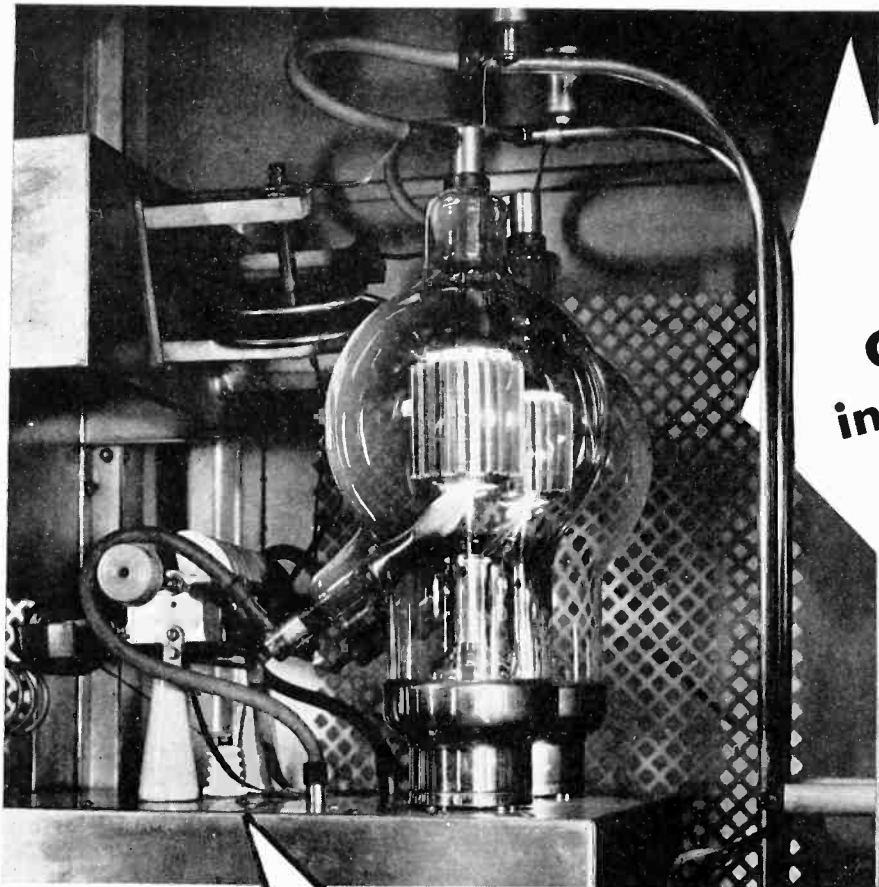

ZENITH
RADIO
 Chooses the Zenith
 in Vacuum Tubes for FM
 Eimac 1500T Tubes tried
 and proven for the job

ZENITH
RADIO
LONG DISTANCE TRADE MARK REG.
1KW FM STATION
W9XZR
 A pair of Eimac 1500T's in the
 final driven by a pair of Eimac
 152TL's and a pair of 35T's

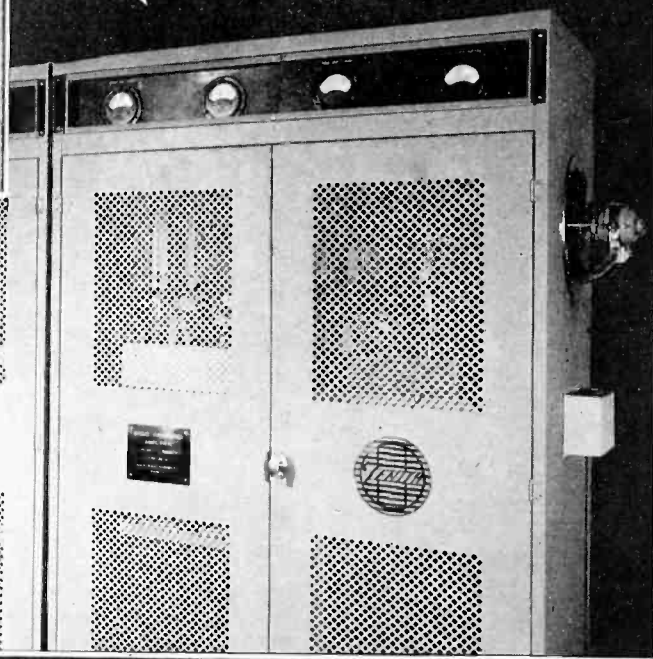

Zenith Radio Corporation in selecting Eimac tubes for their FM station took no chances with untried tubes. Eimac tubes have been in FM almost from the time experiments were begun. Major Edwin E. Armstrong's revolutionary Frequency Modulation scheme has put them to the tests for a matter of years. Now you can save time and money by simply following the leader in selecting the tubes for your new FM Station.

Eimac tubes have been consistently out in front in the outstanding NEW developments in radio. It will pay you to investigate their many advantages. See advertisement in September Electronics for list of representatives or write direct for further information.

In Use by
 Practically
 every Major
 Airline

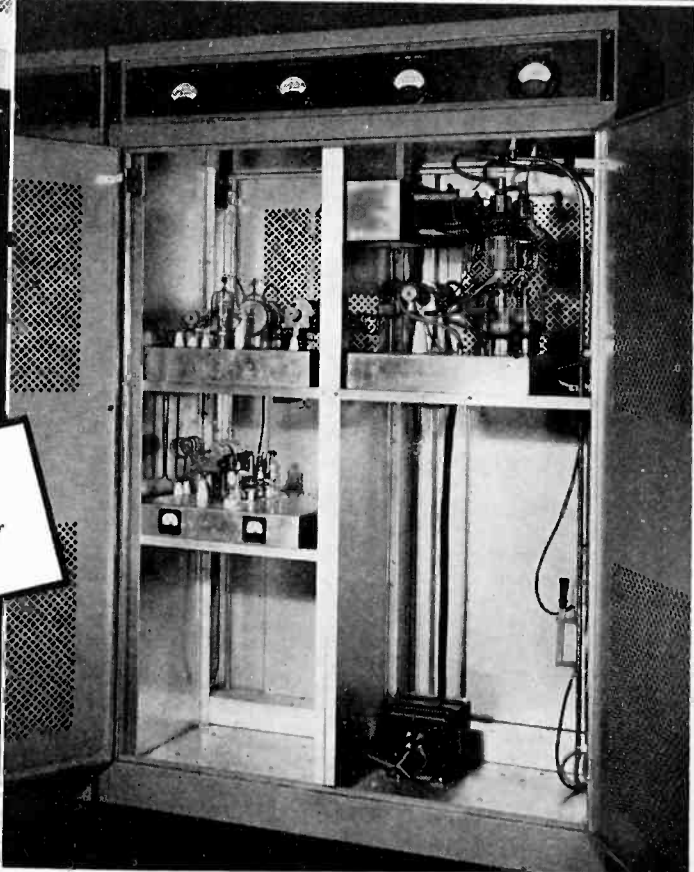

Eimac
TUBES
 EITEL-McCULLOUGH, INC. San Bruno, California

The Ideal Control for A.C. Circuits

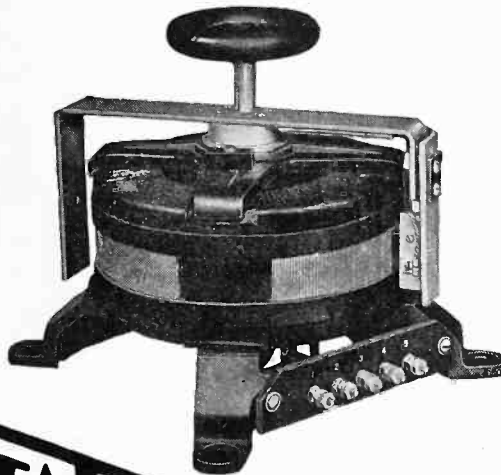

TRANSTAT VOLTAGE REGULATORS

THE Type "TH" Transtat Regulator is being selected for numerous voltage-control applications because of its many advantages over resistive and tap-changing methods. Voltage may be changed gradually, and without circuit interruption, from zero to values considerably higher than line voltage. Moreover, it offers high efficiency, flexibility, good regulation and rugged construction at low cost. All of these features are possible in the Transtat because it is a continuously variable auto-transformer—the ideal voltage control for alternating-current circuits.

● Send for new 20-page bulletin with complete engineering data.



AMERTRAN

Manufactured
Since 1901
at Newark, N. J.

AMERICAN TRANSFORMER CO.

178 Emmet St., Newark, N. J.

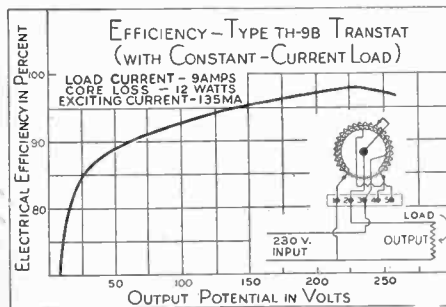

Typical efficiency curve for Type "TH" Transtat Regulator

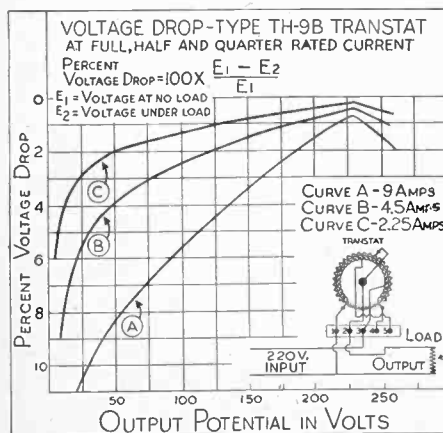

Typical regulation curve for Type "TH" Transtat Regulator.

RATINGS

For loads from 500 Va. to 20 Kva.
For 115-, 230- or 460-volt input.
For single-phase or poly-phase service.
For frequencies of 25, 50 or 60 cycles.
Output range 0 to 113% of input voltage.
Rated current at any output voltage.
Manually operated, air-insulated type.

CHARACTERISTICS

Smooth control without circuit interruption.
High Efficiency* under all operating conditions.
Good regulation*—output voltage practically independent of load.
Low operating temperature —55° C. rise.
Voltage change is at uniform rate.
Practically no effect upon power factor.
Low exciting current—from 1% to 6%.
Does not cause wave-form distortion.

FEATURES

Small size and light weight for power rating.
Mounting is rugged, ventilated and reversible.
Brush is self-aligning and counter-balanced.
Dials are calibrated to indicate output voltage.
Polished Commutator prevents sparking and arcing.
Glass coil insulation prevents damage from heat.
Several units may be ganged on one shaft.

NEW CATALOG

Catalog (20 pages) gives complete data on 63 standard ratings, including 12 pages with 26 diagrams telling "How to use the Transtat."

*See Performance Curves

AMERICAN TRANSFORMER CO.
178 Emmet St., Newark, N. J.

Please send me Bulletin 51-2 with complete data on Type "TH" Transtat Voltage Regulators.

Name

Company

Address

City

State

**You'll Find Plenty of Changes in
1941 Autos at the National Show!**

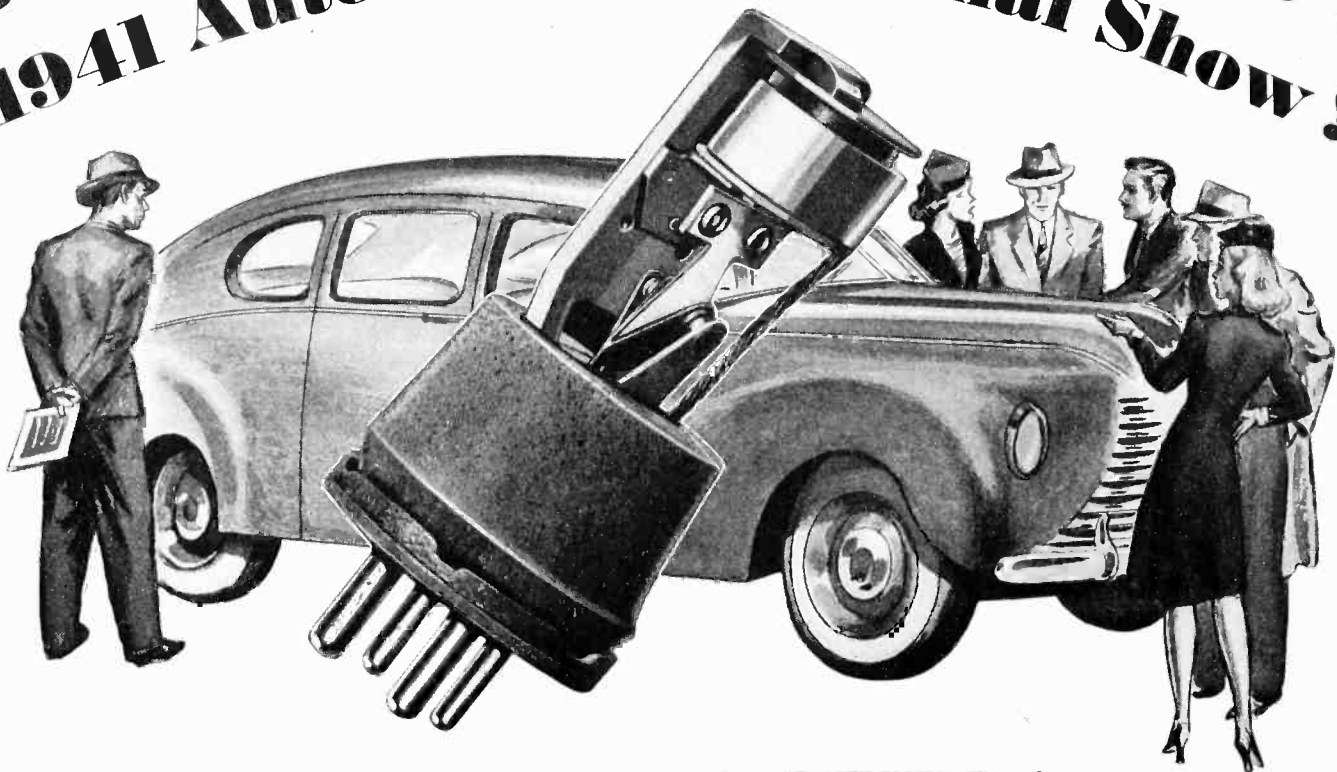

**But You'll Still Find P. R. MALLORY & CO. Inc. MALLORY Vibrators
the Leaders in 1941 Auto Radios!**

In a world of change . . . certain names grow great as the symbols of unchanging leadership. The names of automobile manufacturers whose absence from the automotive field would leave a great, unclosed gap. The names of radio manufacturers who have weathered the storms of spectacular growth. Among such names, Mallory has won a well-deserved place. Year after year, the leadership of Mallory products remains unchallenged. Mallory Vibrators are an excellent example. They have contributed much to the

very growth and practicability of automobile radios . . . and throughout that growth have maintained a clear, wide lead over any other vibrators. Each year the list of radio manufacturers using Mallory Vibrators as original equipment reads like a Blue Book of the industry.

Naturally, there's a reason and it can be given in one word . . . Performance.

If the use of your products depends on the conversion of power from low voltage or battery sources . . . you owe yourself a demonstration of that performance.

P. R. MALLORY & CO. Inc.
MALLORY

P. R. MALLORY & CO., Inc., INDIANAPOLIS, INDIANA • Cable Address—PELMALLO

Serves the Aeronautical, Automotive, Electrical, Geophysical, Radio and Industrial Fields with . . . Electrical Contacts, Welding Electrodes, Non-Ferrous Alloys and Bi-Metals . . . Rectifiers, Dry Electrolytic Capacitors, F.P. (Fabricated Plate) Capacitors, Vibrators, Vitreous Resistors, Potentiometers, Rheostats, Rotary Switches, Single and Multiple Push Button Switches, Electronic Hardware.



CROSS TALK

► **N.T.S.C.** . . . Actively, and for the most part with open minds, several engineering committees are at work to settle the perplexing problem of standards for television. Before the new year sets in, standards are expected to be ready for proposal to the Government, standards which the industry directly interested in television as well as non-commercial bodies will have agreed upon.

It is well to remind engineers, however, that certain matters cannot be explained by the best of mathematicians or scientists or practical engineers. These matters deal with the public taste. No formula has ever been worked out which will tell a manufacturing company what the public will "go for." No one knows this better than book publishers or theatrical producers. A book with every chance of success may never sell enough copies to get the publisher out of the hole; and a musical comedy or a serious drama may require an expenditure of many thousands of dollars to produce—and it may flop on the first night.

Television may really get off to a good start with all the technique in good order—but the public may turn thumbs down. The early days of radio were filled with annual dumpings of surplus stock. Most of this was due to over production. But over-production is only an indication of lack of buying. Only after a set is engineered and on the market, after thousands of dollars and much time have been put into tools, after dealers' stocks are on the floor—only then can the manufacturer tell if his product has a chance of being sold.

The standards committee has some knotty problems to cope with. Should

there be fewer frames and more lines, or more frames and fewer lines, should color be added to the images, within the existing bandwidth with the necessary decrease in number of lines—these engineering questions involve subjective matters, they involve the public. And they ought to be decided soon.

Would it be feasible for the industry to finance some sort of public demonstration to which television problems could be brought in experimental form before anyone went into production? Let people see a system in color simultaneous with higher definition in black and white. Let the public vote. Which would they prefer? Engineers could secure much guidance from such public reaction; they might find exponents and coefficients that would fit nicely into their cold engineering formulas. In England, the government which ran television (as well as all broadcasting) put two systems on the air for a trial period. The people finally decided which they preferred. Thus much capital, and time, and labor were saved.

► **WAR** . . . Speculation regarding German mobile radio equipment was commented on in this column recently. Newspapers had carried accounts indicating the possibility of the Germans using frequency modulation in tanks and planes. Inquiries to our friends in England did not produce any great amount of information but our informant has the following to say: "Personally I should doubt very much whether fm was being used on any extensive scale, both because it would have meant equipping the mobile units with apparatus much more up-to-date than seems to be in general use by

the Germans and, secondly, because from what one has been able to glean, the nature of the warfare was not such as to necessitate constant and easy communication with the bases."

► **CANVAS** . . . In the commuting train recently we overheard two men in conversation. It seems that of all the products advertised by radio, only two were recognized by one of the men. These products had the air *just before* two very popular programs. With this as a start we made a canvas, and it now seems to us that the choicest spots on the air are these "just before" spots. People tuning-in to popular programs do so a minute or two before the program changes and get in on the sales talk at the end of the previous broadcast period.

"And remember, Tootsie soap flakes taste good!"

► **DEFENSE** . . . Technical and engineering societies in all walks of life are endeavoring to aid the defense campaign by classifying their members as to their qualifications and their value to the Government in time of need. Thus a man who is an expert at something or other will have a somewhat better chance of being more useful in time of trouble than if he carries a hod.

If any of *Electronics* readers wish to set down their qualifications which would enable them to perform specialized services in war time, let them write these descriptions to us. The editors will not act as recruiting agents; the folders containing this information will be confidential until the Government wishes to see them.

TUBES AND TOOTHPASTE —A CASE HISTORY

Plant engineers of the Bristol-Myers factory have put 25 phototubes to use in five different applications—without hiring an electronic specialist. How they did it reads like a prescription for production ills throughout industry

WHILE it is true that electronic methods of control have been widely applied in such processing industries as welding, in specialized equipment such as wrapping and packaging machinery, and in a multitude of isolated uses, it is seldom that factory engineers have made a systematic attempt to use electron-tube methods throughout a plant, wherever and whenever tubes can do a better job than the existing methods. Several months ago, the editors of *ELECTRONICS* heard that such a frontal attack had been made by plant engineers of the Bristol Myers Company at Hillside, New Jersey. In this plant are manufactured a variety of pharmaceutical products such as tooth paste, shaving cream, hair tonic, etc. A total of 25 phototubes and associated relays and a public address system are used in this plant. The phototube relays are used for a variety of applications such as controlling a high speed package wrapping machine, positioning tooth paste tubes in a filling machine,

By **CRAIG WALSH**

Assistant Editor, Electronics

and controlling an automatic scale. The success of this company in the application of electronics has been due largely to the underlying philosophy of the men in charge of mechanical operations. The philosophy is simply that the best way to perform an operation is by the simplest and most direct method. By that is meant that an electronic circuit should not be used if an electrical non-electronic method will do the same thing in a simpler and more direct manner. Moreover an electrical method should not be used if a mechanical method will perform the same operation in the simpler and more direct manner. For example, a phototube relay should not be used to count slowly moving objects where a simple mechanical counter will be satisfactory. Or if a remote indication of such a counting operation is required, the phototube should not be used because an electrical switch operating a sole-

noid counter at the remote point will do the trick. On the other hand, to determine whether a clear glass jar is filled with the proper amount of contents, the simplest way is to direct a beam of light on the jar and place a phototube on the other side. If the jar is full nothing occurs, but if it is only partly full, the light beam passes through to a phototube which operates a relay and actuates an alarm. Hence, the first step towards success in using an electronic device is to apply it only to those operations which cannot be performed better by mechanical or electrical methods.

Design Personnel

The design, installation and maintenance of the phototube devices in the Bristol-Myers plant is in charge of the man who is also responsible for improvements in mechanical operations throughout the plant. The background of this man is of interest to engineers considering the introduction of electronic methods into their own plants. He is

Empty toothpaste tubes are loaded on the conveyor in a random manner at *A*. When the conveyor moves forward and the tubes occupy the positions in front of the phototube units *B*, they are rotated by shafts *F* until the yellow line *C* in the black base faces the phototube. At this time because of the higher reflectance of yellow, the phototube causes the thyatron tubes *D* to fire. This operates the solenoids *E*, to disengage clutches stopping the rotation of the shafts in the tubes

The paper feed mechanism of a high speed package wrapping machine is shown here. As the black marker *A* passes the phototube *B* a light beam is interrupted. A thyatron relay trips causing the solenoid *C* to operate a differential gear retarding the paper which is fed at a rate slightly in excess of the requirements. This places the paper in position for accurate cutting by a rotating knife. The rate of operation of this machine is 160 packages per minute

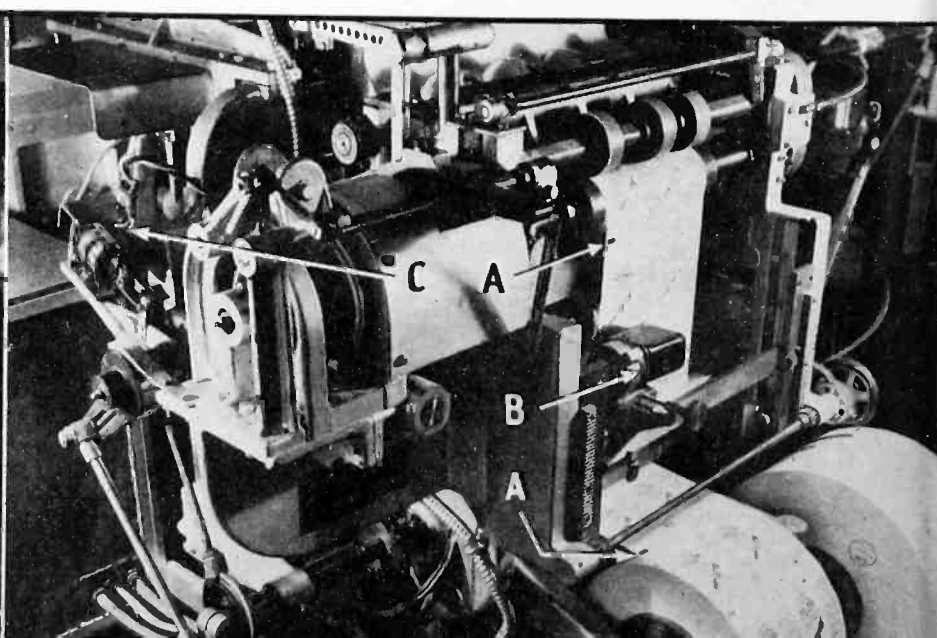
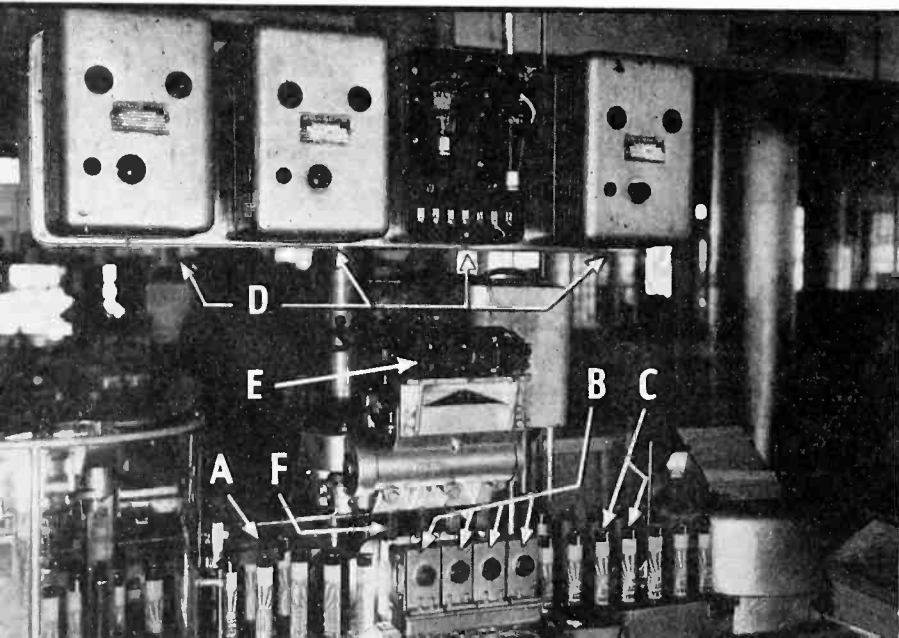

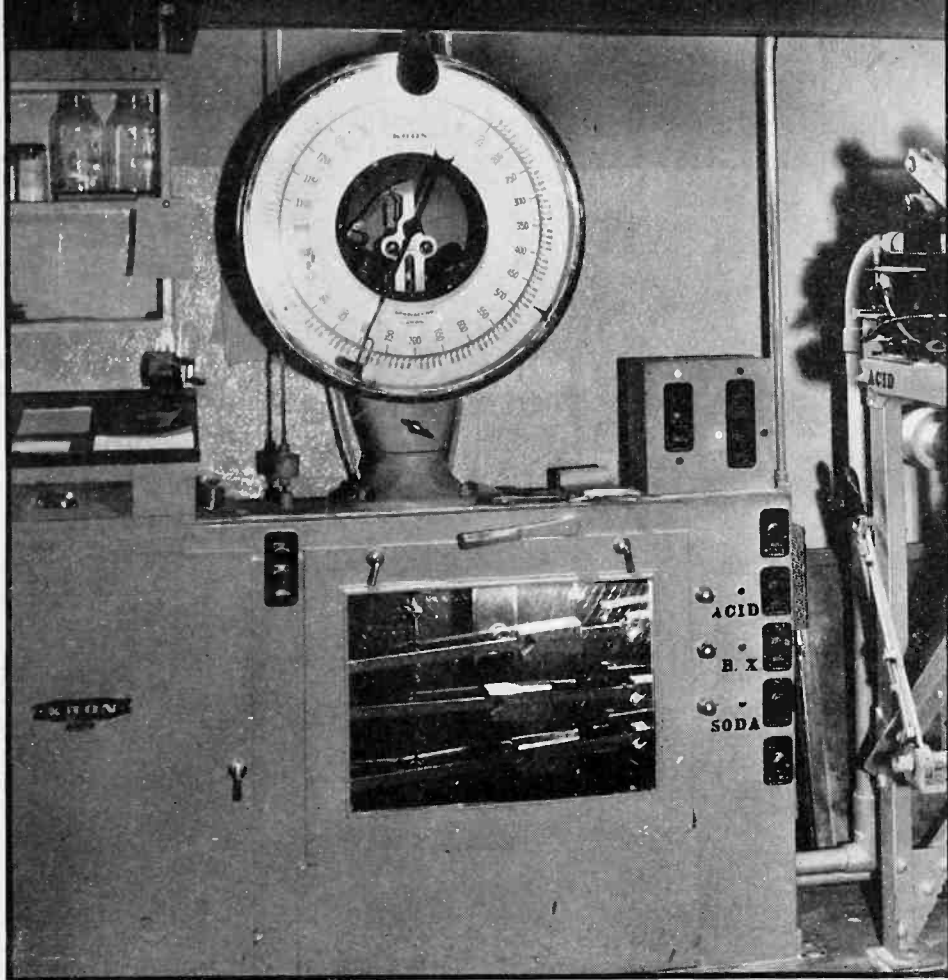

A phototube is used to control this automatic scale. The pointer is set to the desired weight and as the amount of material on the platform increases, it moves toward the zero point. Located behind a small window at zero is a phototube. When the pointer reaches zero the flag attached to it covers the window cutting off the light reaching the phototube. The material flowing to the platform is then automatically stopped



Properly and improperly sealed tooth paste tubes. The phototube equipment shown at the lower left insures that the tubes are properly lined up

a capable mechanic as well as a capable production engineer. His formal engineering training was that of a civil engineer and although he was engaged in amateur radio activities for several years, he had never as much as seen a phototube until he entered the employ of Bristol-Myers about seven years ago. This fact emphasizes two points: First, the presence of a highly trained electronics engineer is not necessary for the successful operation of a phototube. Secondly, a man who has the ability to be successful as a production engineer in a well organized industrial plant also has the ability to obtain enough knowledge of electronics to ensure the proper operation and maintenance of such devices as phototube relays.

The success of electronic devices depends to a great extent upon the mechanical aspects of the problem. It must be remembered that a circuit is merely a control device. No matter how perfect a circuit may be, it is utterly useless unless it is used in conjunction with an electro-mechanical link to perform some mechanical operation. That link may take any one of many forms.

It may be a solenoid, an indicating or recording meter, a lamp to give an alarm, or it may be another electronic circuit used to adjust a current through or a voltage across some device such as a motor. Phototube relays and other similar equipment may be purchased in package form ready for application to some mechanical equipment where they can profitably control some phase of its operation. They are available in a practical form. The design problems as such have been solved. It is fully accepted that they will perform their functions in a reliable manner. The problem remaining is to apply them and this is a mechanical problem, quite capable of solution by mechanical engineers who may not be acquainted with electronic theory. The maintenance problem is quite similar. It has been the experience of the Bristol-Myers group that the greater part of the maintenance trouble has been of a mechanical nature, and not due to failure in the electronic device itself.

During the several years of operation, the failure of the component parts of phototube relays and associated equipment has been al-

most negligible. On the other hand, dirty lenses, misalignment of parts, neglect of the effects of stray light on a phototube, and the like have been the source of trouble.

All this is not to say that the circuit end of the problem can be neglected. The point is that a large variety of electronic devices can be purchased from a number of companies who will install them properly. After this, the production engineers and maintenance mechanics may become familiar with their characteristics so that they may continue to function in a satisfactory manner.

The 25 phototube relays in normal everyday operation in the Bristol-Myers plant perform the following operations: Cause tooth-paste tubes in a conveyor to face all in the same direction; determine whether glass bottles are filled with the proper amount of contents; cut and determine the correct register of wrapping paper in a high speed machine; permit automatic operation of a scale weighing the ingredients of one of the products, and open doors when a worker approaches. These applications are not particularly new, but they are

interesting and important because they are installed in one plant, operating day in and day out, continuously. Essentially the same circuit is used in the phototube relays in each of the various applications. It is shown in the accompanying diagram. The output of the phototube is delivered to the grid of an amplifier tube to be increased to a voltage sufficient to operate a thyatron tube. The thyatron acts as a relay which passes current during the desired periods of time. The output of this tube furnishes the power to operate the electro-mechanical link which, in the case shown in the diagram, is a relay. The circuit operates on alternating current and contains no direct-current power supplies. The light source used in each case is an ordinary double filament automobile headlight.

Phototube Corrects Positioning of Label

One of the first operations to which electronic control was applied in this company was that of insuring the proper positioning of the label and the flat press or seal at the bottom of the tooth paste tube. The method used previously was to have the tubes positioned in the conveyor by hand. This required the use of an operator exclusively for this operation. Electronic control has eliminated this operator with resultant savings in manufacturing cost. The operation is now performed by a battery of phototube relays. The apparatus is shown in the photograph. The motion of the conveyor is from left to right and it is loaded by an automatic machine with the tubes facing in random directions. The motion of the conveyor is intermittent and with each movement four tubes are placed in position in front of the phototubes. A shaft descends into the open end of each tube. The shafts rotate and carry the tubes with them. The tubes turn until a spot of light falls upon a narrow yellow line on the base of the tube, as shown in the photograph. At this time, because of the greater reflectance of yellow compared with black, a greater amount of light reaches the phototube. At this time the control circuit stops the rotation of the tube, leaving it facing in the proper direction. The sequence of operations is as follows:

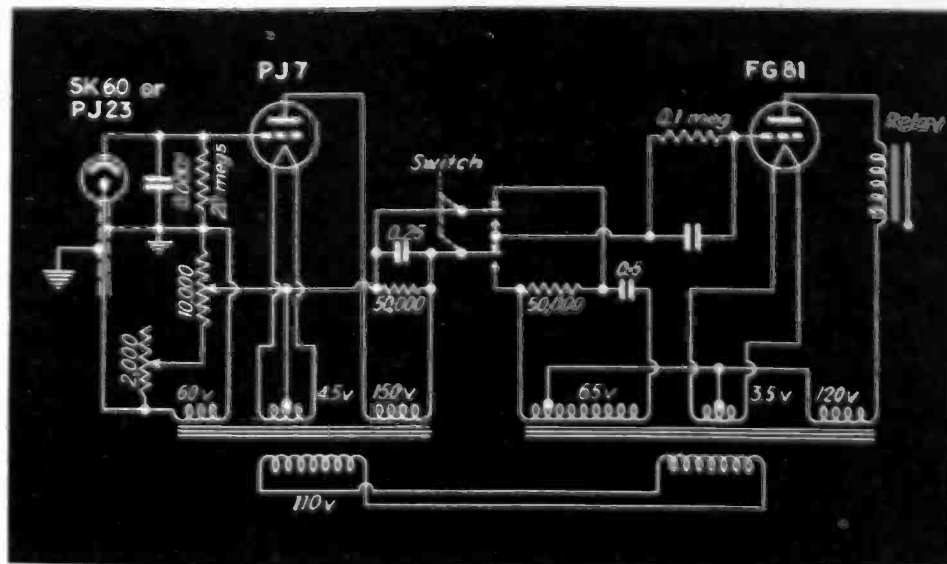

Circuit diagram of a typical phototube relay. Essentially the same circuit is used on all of the phototube installations in use in the Bristol-Meyers plant. It can be made to operate either on an increase of light on the phototube or on a decrease of light by means of the switch

When the increased amount of light reaches the phototube, a current flows through it. This current is amplified and the resultant signal applied to the grid of a thyatron, through which a relatively heavy current then flows. This current is used to operate a solenoid which in turn operates a clutch on the rotating shaft, which thereupon stops. The shafts are lifted out of the tubes, which then continue on their way to the filling and sealing machines.

The difficulties of this installation were mostly of a mechanical nature. One in particular had to do with the positioning of the light source and the phototube. At first, they were placed so that the phototube was on the line of mirror reflection from the surface of the tooth paste tube. The relay didn't work because there was no differentiation between the black and yellow colors as far as the amount of reflected light was concerned. However, when the phototube was placed

at a point on a line perpendicular to the reflecting surface, use was made of the scattered reflected light with the result that there was a distinct difference in the light levels reflected by the black and yellow portions of the surface.

Also, because of the low level of the light by the time it reaches the phototube, care must be exercised in avoiding the effects of extraneous light on the phototube. It is important that the lens system be kept free of dirt and grease. It has been found that the life expectancy of the phototubes when used seven hours per day is about three or four years.

High-Speed Package Wrapper

Another electronically-controlled machine is that which wraps a small package, $1\frac{1}{2}$ inches by $1\frac{1}{2}$ inches by $3\frac{1}{2}$ inches, in a waxed paper wrapper at a rate of 160 packages per minute. The waxed paper has imprinted on it a label and directions for use of the contents of the pack-

Here a phototube device is checking the bottles to be sure they are filled just before they enter the capping machine. If a bottle is only partly full, a light beam passes through the bottle to the phototube. In such a case an alarm is given so that the partly full bottle may be removed

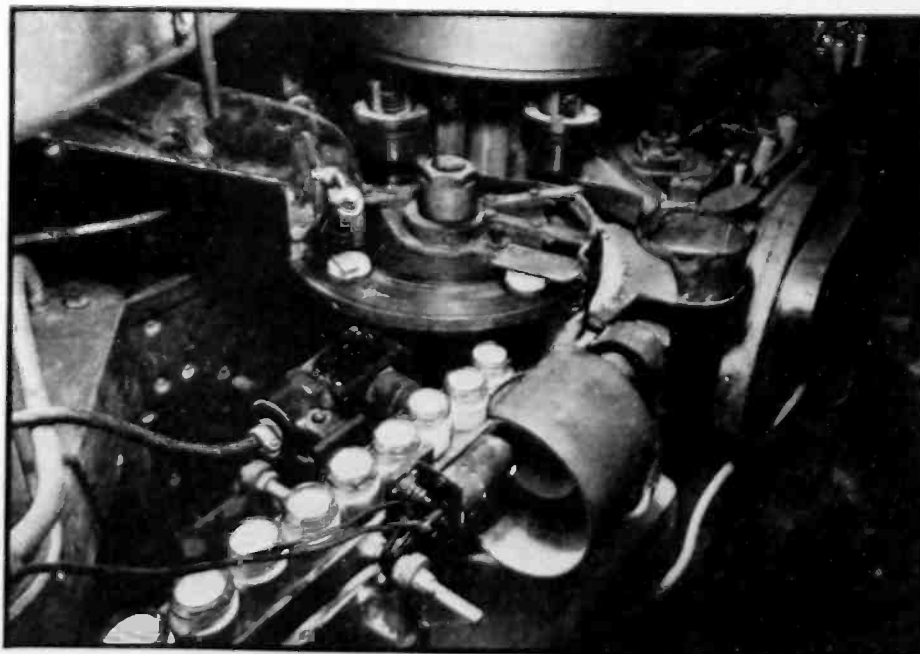

age, covering the four sides and top. The problem is to place the wrapper on the package in exactly the same position each time and to have the printed matter properly centered on each face. The paper is fed from a reel in a continuous strip at a rate slightly faster than is necessary. Along the path of the paper is located a phototube unit through which the paper passes. At predetermined points on the paper there are a series of black markers. As each marker intercepts the light beam in the phototube unit, the absence of light on the phototube causes the associated thyatron relay to operate a solenoid which retards the paper just enough so that a continuously rotating knife cuts the paper in the proper place. The principle of operation is that the paper is fed at too rapid a rate and the phototube relay acts to slow it down by just the right amount. The accuracy of this machine is such that the label is consistently placed on the package within 0.02 inch of the correct position. As in the case previously mentioned, the main source of trouble lay in the mechanical arrangement of the various parts of the mechanism. The rapidly rotating knife, the fast moving paper, the solenoid and clutches all had to be synchronized for the proper operation of the machine.

Phototube Checks Bottles

To be sure that all bottles containing a preparation of white pow-

der have been properly filled another phototube relay has been put to work. The bottles move closely spaced along a belt conveyor. A light source is placed on one side of the conveyor and a phototube directly opposite. If the bottles are all full, the light beam remains broken and nothing happens. If, however, one of the bottles is only partly filled the light beam passes through the bottle to the phototube. As previously described, the increase of light on the phototube causes the thyatron tube to trip, permitting a current to pass through it. This time, instead of operating a solenoid, the current lights an incandescent lamp to attract the attention of the nearby operator. This unit has been in continuous use for almost four years, with practically no maintenance.

Automatic Scale

An automatic scale which weighs the three ingredients of one of the pharmaceutical preparations makes use of another phototube relay. The dial of this scale operates in a manner just the reverse of the conventional scale. The pointer is set to the desired weight and as the weight of material on the platform of the scale increases, the pointer moves towards the zero mark on the dial. Behind a window at the zero point there is a phototube and directly in front of it a light source. Attached to the pointer is a small flag which covers the window when the weight on the platform equals the weight called for, thus cutting off the light

to the phototube. The relay then operates to cut off the supply to the scale.

At one point in the plant, material must be transported from one room to another between which is a normally closed door. The arrangement shown in the photograph is similar to those found in many places such as railroad stations. As the operator or the truck moves toward the door, a light beam is interrupted causing the phototube relay to set in operation the door opening mechanism. A light beam is directed diagonally through the door to another phototube on the other side to insure that the doors remain open while the truck is passing through. As long as there is an object within the door area, the light beam is cut off and the door remains open. When the object is removed the light beam falls on the phototube, causing the door to close.

Loudspeaker System Facilitates Shipping Room Operations

The electron tube applications thus far described make use of phototubes. These are not the only tubes useful in factory operations. The ordinary garden variety of sound system also has its uses. This is exemplified by the sound system installed in the shipping room. It is used to transmit orders of the chief clerk to members of his crew working considerable distances from him. It is only necessary for the clerk to call out the name and address of customer and the material he wants to have the order filled and delivered to a waiting truck. A conveyor system extends the length of the shipping room to take advantage of the speed of operation offered by the use of amplified sound. Workers located at various points load the material on the conveyor and others further along stencil the name and address on each package. The clerk is in a position to check each order as it passes by him.

The loudspeaker system makes it unnecessary for a number of clerks to travel around the stock room with cumbersome trucks in time consuming work. Now the work is performed in a very efficient manner with very few delays and allows the company, even in periods of rush business, to fill each order the same day it is received.

As the worker approaches this door he steps into a light beam. The door then opens and remains open until both the worker and the truck have completely passed through the door



Vertical vs Horizontal Polarization

IN ultra-high-frequency transmission, for aural broadcasting and for television broadcasting purposes, the transmitting antenna is usually located at a point well above the surface of the earth. This may be accomplished by placing the antenna on a tall building or on a high tower erected for the purpose. In the average receiving location this procedure is not possible. Here it is generally not practical to raise the receiving antenna to a height much greater than fifty feet. Often a height much less than this figure must be accepted. It is generally conceded that as great a height as possible is desirable at the receiving location, up to the point where the free-space wave and the wave reflected from the ground begin to cancel. At the same time, such factors as appearance, cost, and accessibility must be considered. These factors may, under certain conditions, be of such consequence that it is desirable to provide a small receiving antenna in or near the receiver cabinet. In many receiving locations in residential districts, the receiver cabinet with the receiving antenna may be only a few feet above the ground. Since it is known that the received signal strength close to the ground exhibits characteristics associated with the polarization of the transmitted signal, it seems desirable at this time to examine this phenomenon more closely than has been done in the past.

Theoretical and Experimental Investigation

In calculating the field intensities in this paper, the formulas given by Trevor and Carter¹ have been used, particularly those given on pages 423 and 424 of their paper. In the calculations, it has been assumed that the earth is flat and uniform, with a known dielectric

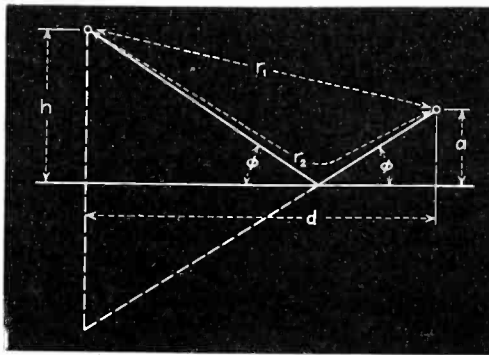

Fig. 1—A transmitting antenna at height h and receiving antenna at height a as used in these experiments. A uniform flat earth is assumed

constant and conductivity. The transmitting antenna (Fig. 1) is at a height h above the surface of the earth, while the receiving antenna is at height a . The horizontal distance between antennas* is d . A direct wave travels from the transmitting antenna to the receiving antenna along the straight path shown as r_1 . Another wave strikes the surface of the earth at the angle ϕ and reflects at the same angle. The magnitude and phase of the wave

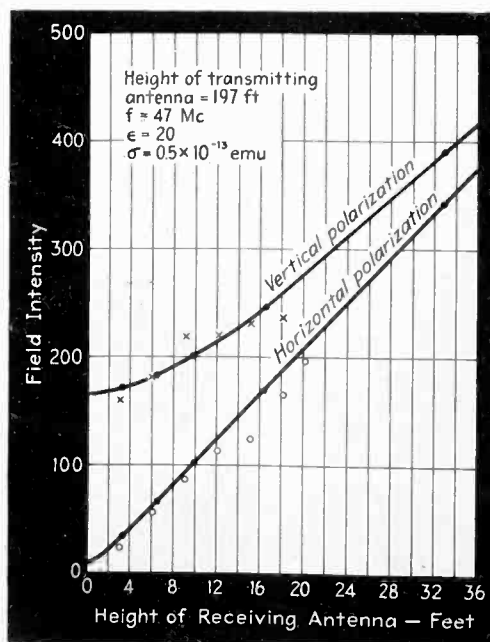

Fig. 2—Field intensity vs receiving antenna height for both types of polarization. The solid curves were computed from formulas and the crosses and circles are experimental points

may be altered on reflection. The amount of alteration is dependent on the frequency and the dielectric constant of the earth, as well as the conductivity and the angle of incidence of the reflected wave. The reflected wave will also arrive at the receiving antenna a little later than the direct wave because the path length r_2 of the reflected wave is greater than r_1 , the path length of the direct wave.

The total field F_V at the receiving antenna, for vertically polarized waves, is

$$F_V = F_D [1 + K_V e^{-\theta}] \quad (1)$$

where F_D = the direct wave

K_V = reflection coefficient

$$= \frac{\epsilon_o \sin \phi - \sqrt{\epsilon_o - 1 + \sin^2 \phi}}{\epsilon_o \sin \phi + \sqrt{\epsilon_o - 1 + \sin^2 \phi}}$$

ϵ_o = a complex dielectric constant

$$= \epsilon - j \frac{18 \times 10^{20} \sigma_{emu}}{f}$$

ϵ = the dielectric constant of the earth
 σ_{emu} = earth conductivity (emu)*

f = frequency (cycles per second)

For a frequency of 50 Mc, with $\epsilon = 15$ and $\sigma_{emu} = 0.5 \times 10^{-13}$, $\epsilon_o = 15 - j 1.8$

θ = phase delay due to difference in path lengths = $\frac{2\pi}{\lambda} (r_2 - r_1)$

$$r_2 - r_1 = \frac{4 h a}{r_2 + r_1}$$

$$r_2^2 = d^2 + h^2 + a^2 + 2ha$$

$$r_1^2 = d^2 + h^2 + a^2 - 2ha$$

λ = wavelength

For horizontally polarized waves,

$$F_H = F_D [1 + K_H e^{-j\theta}] \quad (2)$$

where $K_H = \frac{\sin \phi - \sqrt{\epsilon_o - 1 + \sin^2 \phi}}{\sin \phi + \sqrt{\epsilon_o - 1 + \sin^2 \phi}}$

When the distance d is very much greater than either h or a , good approximations to (1) and (2) are as follows:²

$$F_V = \frac{F_D}{d} \left[\frac{2 \epsilon_o (h+a)}{\sqrt{\epsilon_o - 1}} + j \frac{4 \pi h a}{\lambda} \right] \quad (3)$$

and

$$F_H = \frac{F_D}{d} \left[\frac{2 (h+a)}{\sqrt{\epsilon_o - 1}} + j \frac{4 \pi h a}{\lambda} \right] \quad (4)$$

* σ (mho — cm) = $\sigma_{emu} / 9 \times 10^{11} = 10^9 \times \sigma_{emu}$
so that
 0.5×10^{-13} mho — cm = 4.5×10^7 esu = 0.5×10^{-13} emu.

Theory and experiment are combined in this comparison of vertically and horizontally polarized ultra-high-frequency waves. Horizontal waves are shown to offer lower field strength but higher signal-to-noise ratio under broadcast reception conditions.

By GEORGE H. BROWN, RCA Manufacturing Co., Inc.

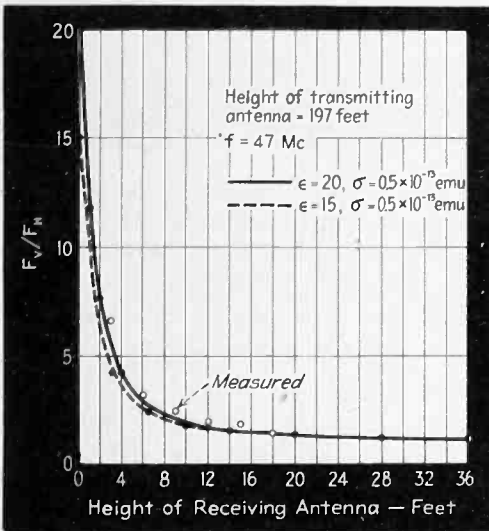

Fig. 3—Ratio of field strengths compared with receiving antenna height for two values of the earth's dielectric constant

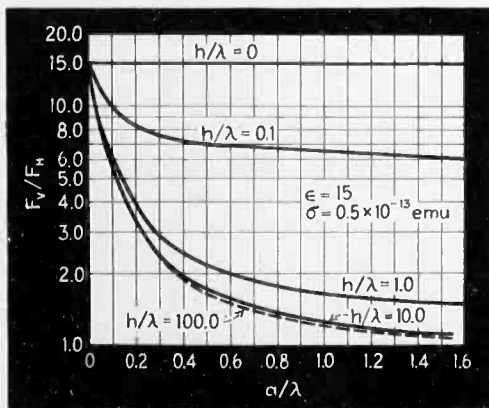

Fig. 4—Ratio of field strengths compared with receiving antenna height for several values of transmitting antenna height

To check these formulas experimentally, a transmitter was located on the roof of one of the buildings of the RCA Manufacturing Company in Camden, New Jersey. A pair of concentric transmission lines fed power directly into the center of a half-wave antenna. This antenna was so arranged that it could be placed either in a vertical or a horizontal position. In both cases, the current in the antenna was held constant. The transmitter was operated at a frequency of 47.0 Mc. The height of the transmitting antenna

was 197 feet above ground level. The receiving antenna was located about one mile distant. This receiving antenna was a loaded doublet, ten inches in length. When the transmitting antenna was vertical, the receiving doublet was placed in a vertical position and when the transmitting antenna was horizontal, the receiving doublet was horizontal. A scaffold was used so that the height of the receiving doublet above ground could be varied. A transmission line ran from this doublet to a calibrated receiver. Relative values of field intensity as a function of receiving antenna height were then obtained. The measured results are shown in Fig. 2. The crosses on this figure show the received signal strength when the wave was vertically polarized, while the circles show the experimental results with horizontally polarized waves. The solid curves on Fig. 2 were computed from Equations (3) and (4), using a dielectric constant of 20 and a conductivity of 0.5×10^{-13} emu for the earth. Figure 3 shows the ratio of F_v/F_H as a function of receiving antenna height for these soil constants as well as for an earth with a dielectric constant of 15 and a conductivity of 0.5×10^{-13} emu. The circles are experimentally determined values taken from Fig. 2.

If Equation (3) is divided by Equation (4), we obtain

$$\frac{F_v}{F_H} = \frac{2\epsilon_0}{\sqrt{\epsilon_0 - 1}} \left[\frac{h}{\lambda} + \frac{a}{\lambda} \right] + j4\pi \frac{h}{\lambda} \frac{a}{\lambda} \cdot \frac{2}{\sqrt{\epsilon_0 - 1}} \left[\frac{h}{\lambda} + \frac{a}{\lambda} \right] + j4\pi \frac{h}{\lambda} \frac{a}{\lambda}$$

It is seen that two antenna heights may be measured in wavelengths to form general relations for a particular value of dielectric constant. The effect of earth conductivity is slight. Figure 4 shows the ratio F_v/F_H as a function of receiving-antenna height for several values of transmitting antennas height. The

receiving and transmitting antennas may be interchanged without changing the results.

To give a better picture of the effects for particular values, the curves of Fig. 5 were prepared. Here a transmitting-antenna height of 60 meters with a transmitter power of 1000 watts are assumed. The dielectric constant of the earth is taken as 15 with a conductivity of 0.5×10^{-13} emu. Since a flat earth is assumed, these curves hold only within line of sight. The field strength increases directly with frequency for large receiving-antenna heights but within a few feet of the ground the increase with frequency is small, particularly for vertically polarized waves. For a given frequency and receiving-antenna height, the signal strength of the vertically polarized waves is always equal to or greater than the signal strength of the horizontally polarized waves.

The data of Fig. 5 were used to prepare Fig. 6, which shows the

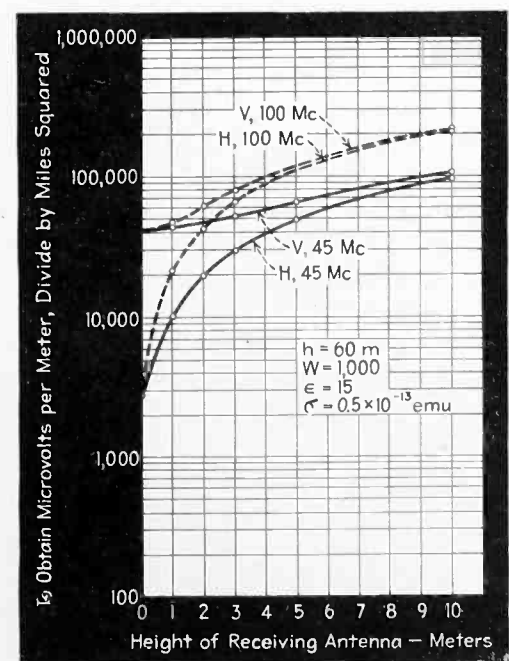

Fig. 5—Comparison of field strengths of both types of polarization at 45 Mc and 100 Mc. These curves are valid only within line of sight

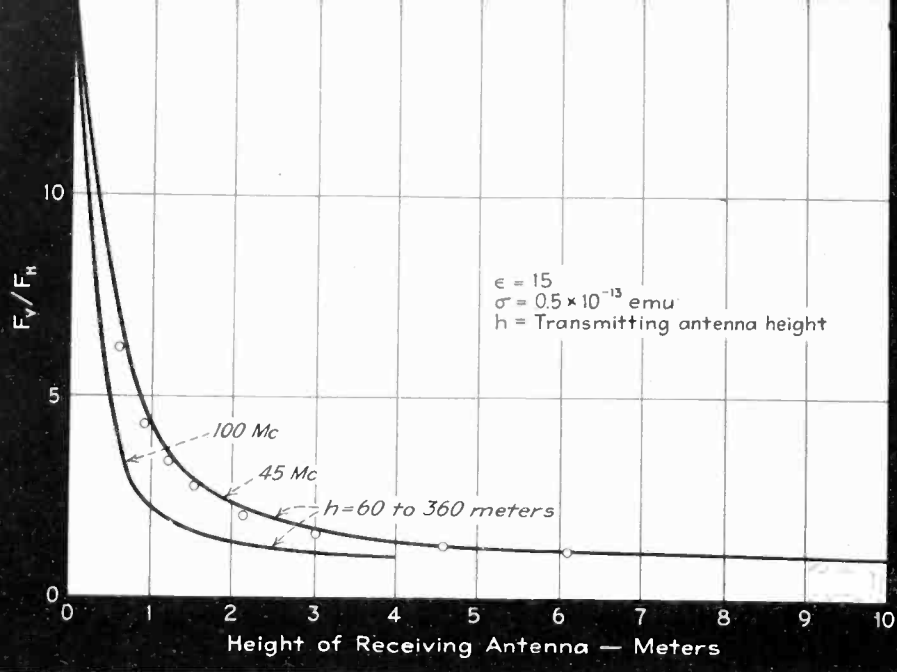

Fig. 6—Ratio of field strengths of vertical and horizontal polarization as a function of receiving antenna height at 45 Mc and 100 Mc. Vertical polarization is superior as far as field strength is concerned

ratio of the vertically polarized signal to the horizontally polarized signal as a function of receiving antenna height for two frequencies. In Fig. 3 of the "Summary of Statement by K. A. Norton on Ultra-High Frequency Propagation," F.C.C. Television Hearing, January 15, 1940, Norton gives values which may be used to compute field strengths at points below line of sight. He shows two curves, one for vertically polarized waves and one for horizontally polarized waves. The circles on Fig. 6 show the values taken from Norton's data. His curves are based on a frequency of 50 Mc, a dielectric constant of 15, and a conductivity of 0.5×10^{-13} emu.

The data considered above show that vertically polarized signals are always equal to or stronger than horizontally polarized signals. However, other factors than direct strength of signal must be considered. In the following work it has been attempted to establish a basis of comparison in which the signal-to-noise ratio is considered. Many observations have shown that there seems to be less interfering noise on horizontally polarized receiving antennas than on vertically polarized antennas. For example, C. J. Young states that horizontally polarized waves "proved to have a real advantage when it came to receiving at Camden, as the horizontal type receiving antenna was noticeably less susceptible to pickup of interfering electric noise." Anderson and Lattimer⁴ found that radiation from motor boat ignition systems appeared

to be largely vertically polarized. Hundreds of further observations and measurements within the R.C.A. organization have shown that a more favorable signal-to-noise ratio is obtained with horizontal polarization.

It has been found possible to use Equations (1) to (5) so that noise pickup properties may be associated directly with the type of polarization, rather than with any selective radiation properties of the noise source itself. In the first attempt along this line it is considered that the noise source is close to the ground, for example three feet above the ground. The noise source is also 100 feet distant from the receiving antenna, measured along the surface of the earth. It is assumed that the radiating system of the noise source is symmetrically distributed with equal horizontal and vertical currents. We now calculate the vertical and horizontal field intensities at the receiving antenna as the receiving antenna is raised from the earth. We call N_v the vertical field intensity from the noise source and N_h the horizontal field intensity of the noise source. The ratio N_v/N_h is shown in Fig. 7 as a function of the receiving-antenna height. If it is now assumed that the desired transmitter is located many miles away at a great elevation, we may use the 45 Mc curve of Fig. 6 to show the ratio of vertical to horizontal field strength of this desired signal. This curve has been included in Fig. 7 for comparison purposes. If we divide the curve,

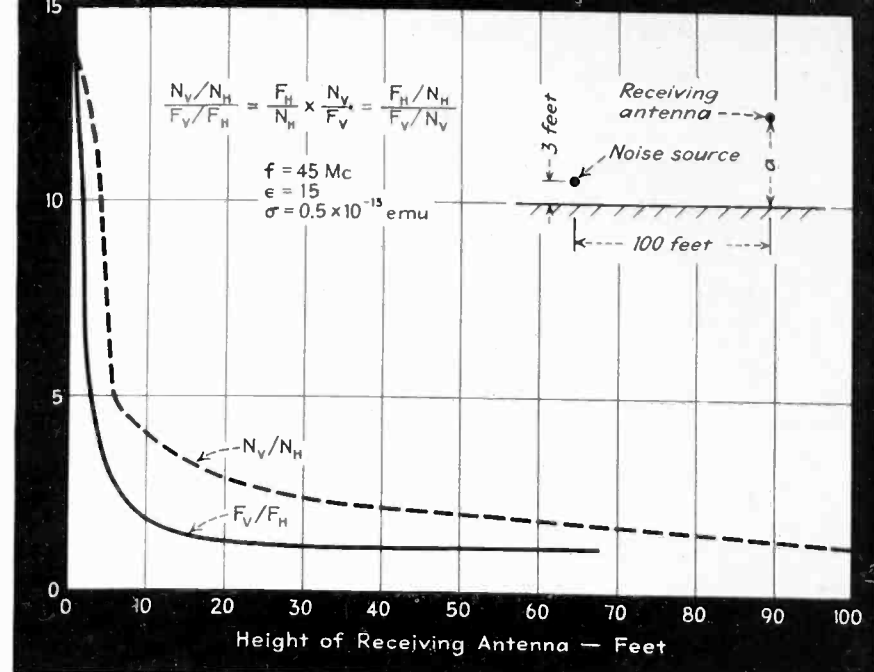

Fig. 7—The ratio of the noise of vertical polarization to that of horizontal polarization compared with the height of the receiving antenna. The transmitting antenna is assumed to be at a great height many miles away

N_v/N_h , by the curve, F_v/F_h , we obtain

$$\frac{N_v/N_h}{F_v/F_h} = \frac{F_h}{N_h} \times \frac{N_v}{F_v} = \frac{F_h/N_h}{F_v/N_v}$$

which is the ratio of horizontal signal-to-noise ratio to vertical signal-to-noise ratio. The result of this division is shown in Fig. 8. It is seen that for receiving-antenna heights of between eight and thirty-five feet, the signal-to-noise ratio of horizontally polarized signals is better than that of vertically polarized signals by a factor of two or greater. At all receiving-antenna heights, the signal-to-noise ratio is most favorable to horizontally polarized waves. The curve of Fig. 8 has been repeated in Fig. 9 and is shown as Curve A. We have made a similar calculation where the noise source is still three feet above the earth but has been removed to a great distance. The results are shown by Curve B, Fig. 9.

Since it has been assumed that the transmitter is at a large height above the ground, a ratio of unity is obtained if the noise source is at a great distance and a great height. This is shown in Curve C, Fig. 9. Also, since internal noise in the receiver is a constant quantity independent of signal strength and not a function of polarization, we may obtain the ratio of signal-to-noise ratios for internal noise by simply plotting F_h/F_v , which is the reciprocal of the lower curve of Fig. 7. This is shown as Curve D, Fig. 9. Because internal noise is a limiting factor only at rather large distances

from the transmitter, it will very seldom be found that internal noise is the only disturbance. We must therefore weight the curve *D* together with Curves *A*, *B*, and *C*, since in almost all cases where *D* is of importance, the conditions which give *A*, *B*, and *C* will be present. The various curves might apply to interference of the following types:

A. Interference from an automobile or from diathermy equipment located 100 feet from receiver and close to the earth.

B. Automobile or diathermy equipment at a great distance from receiver and close to the earth.

C. Diathermy equipment at a great distance from receiver and located in a tall building.

D. Internal receiver noise.

If we were to take the arithmetical mean or average of the curves of Fig. 9 we would not have a fair average for the average of the reciprocals of the values (ratio of vertical signal-to-noise ratio to the horizontal signal-to-noise ratio). It seems much more reasonable to use the geometric mean of the curves since then the reciprocal relation would hold. On this basis, Curve *E* is the mean of Curves *A*, *B*, and *C* obtained from

$$E = (A \times B \times C)^{1/3}$$

Here internal noise is neglected.

Curve *F* takes into account internal noise and is obtained from

$$F = (A \times B \times C \times D)^{1/4}$$

Figure 9 is based upon a frequency of 45 Mc. Figure 10 is an identical set of curves based upon a frequency of 100 Mc. Figures 9 and 10 show that where internal noise is not a contributing factor, a more favorable signal-to-noise ratio is obtained with horizontally polarized waves than with vertically polarized waves for all receiving-antenna heights.

Where internal noise is also included, horizontally polarized waves are superior for receiving-antenna heights greater than four feet.

In the above considerations it has always been assumed that the transmitting antenna is at a great elevation. In aural broadcast and television service on the ultra-high frequencies this assumption will almost invariably be true. A case of importance where it is not valid is in the case of communication between two mobile units such as police cars. In this case we assume the transmitting and receiving antennas each to be three feet above ground. We also assume our noise sources to be arranged as were those considered in Fig. 9. The following results are then obtained.

Frequency	45 Mc.	100 Mc
F_v/F_H	7.4	4.12
<i>A</i>	1.62	0.888
<i>B</i>	1.0	1.0
<i>C</i>	0.565	0.562
<i>D</i>	0.135	0.242
<i>E</i>	0.97	0.795
<i>F</i>	0.592	0.59

From this tabulation we see that in the case of communication between mobile ground units, vertically polarized waves have a slight advantage where receiver noise is not a major item while these same vertically polarized waves have a great advantage where receiver noise is great.

Conclusions

The results of this investigation show that vertically polarized waves yield a stronger signal close to the earth than do horizontally polarized waves. As the receiving antenna is raised, the two types of polarization yield practically identical field intensities, when the transmitting antenna is at least one wavelength above ground.

In spite of the preponderance of

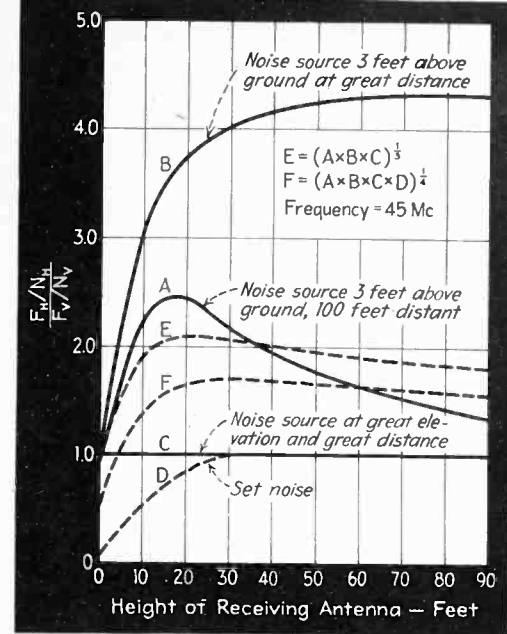

Figs. 9 and 10—Ratio of signal-to-noise ratios of both types of polarization for various locations of the noise source. Horizontal polarization has considerably higher signal-to-noise ratio for all locations of the noise source

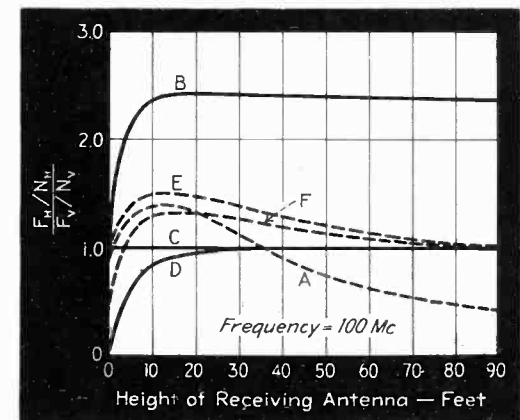

the vertically polarized field near the surface of the earth, horizontally polarized waves yield a more favorable signal-to-noise ratio for television and aural broadcast services (between 30 and 100 Mc) where the transmitting antenna is at least a few wavelengths above ground level. Thus the desirability of horizontally polarized transmissions for broadcast services is clearly indicated.

In the case of transmission between two mobile units with both transmitting and receiving antennas near the ground, a more favorable signal-to-noise ratio is obtained with vertically polarized waves.

Fig. 8 — Ratio of signal-to-noise ratios of the two types of polarization. The horizontal polarization is superior in this respect

(1) Bertram Trevor and P. S. Carter, "Notes on Propagation of Waves below Ten Meters in Length," *Proc. I.R.E.*, March, 1933.

(2) Identical results have been published by Burrows, Decino, and Hunt. (*Proc. I.R.E.*, Dec., 1935; page 1532). The formulas are repeated here for the sake of completeness and because we shall apply them to particular cases.

(3) C. J. Young, *Proc. I.R.E.*, Vol. 22, page 1290, November, 1934.

(4) C. N. Anderson & I. E. Lattimer, *Proc. I.R.E.*, Vol. 20, page 415, March, 1932.

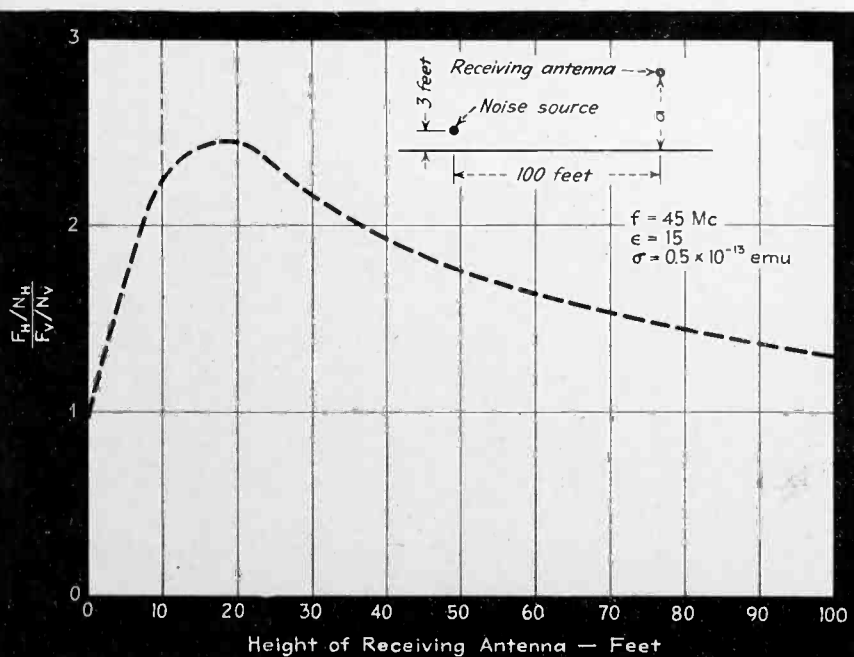

TELEVISION CHANGEOVER

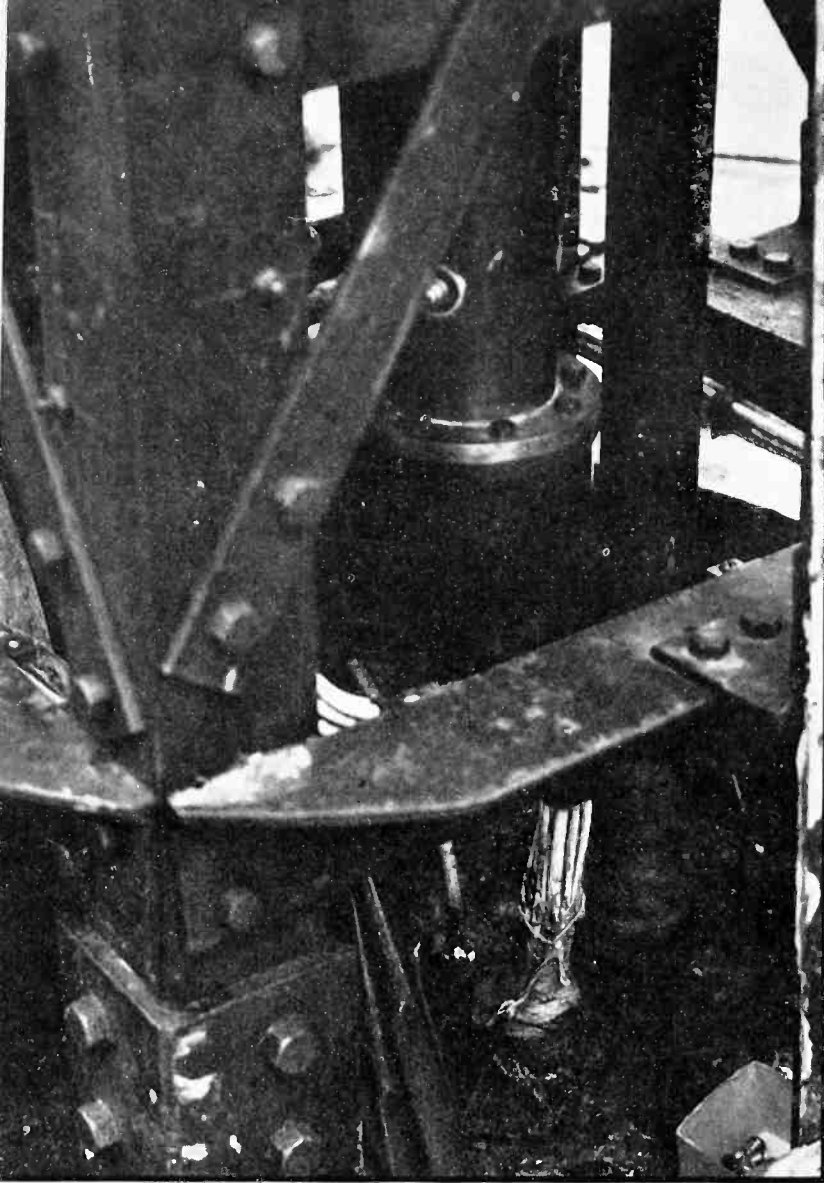

At the base of the radiator tower is an ingenious impedance-matching circuit of coaxial elements which was opened, cut down to the proper size for the new frequency, and reassembled. This was one of the first jobs in the still uncompleted process of retuning the transmission line set-up

A section of the single sideband filter, torn apart and waiting for the hack-saw. After reassembly the long process of adjusting the circuits electrically begins, first under low power and then, if all goes well, under full output

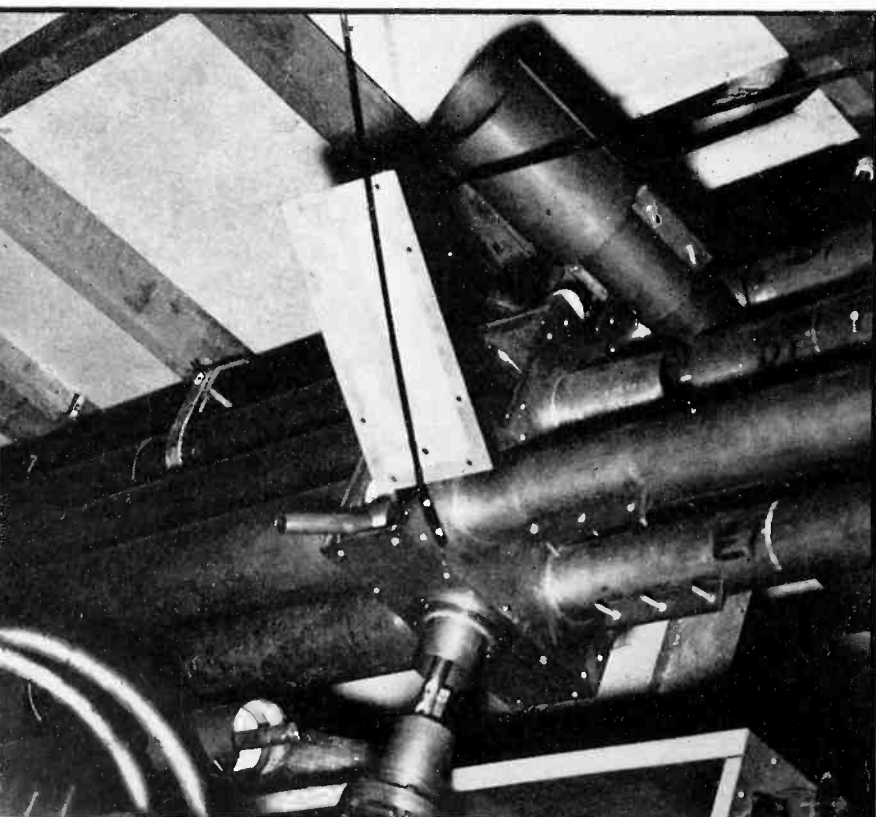

The final amplifier of the picture transmitter, which is grid-modulated over a five Mc band, must be carefully adjusted before full output is obtainable without trouble from parasitic oscillations. When this picture was taken, work on the "final" had not been started, was viewed as a long headache by the operating staff



In accordance with the F. C. C. action shifting the number one television channel from 44-50 Mc to 50-56 Mc, engineers of the National Broadcasting Company in New York are busy at the Empire State Building retuning the transmitter of W2XBS from crystal to radiator

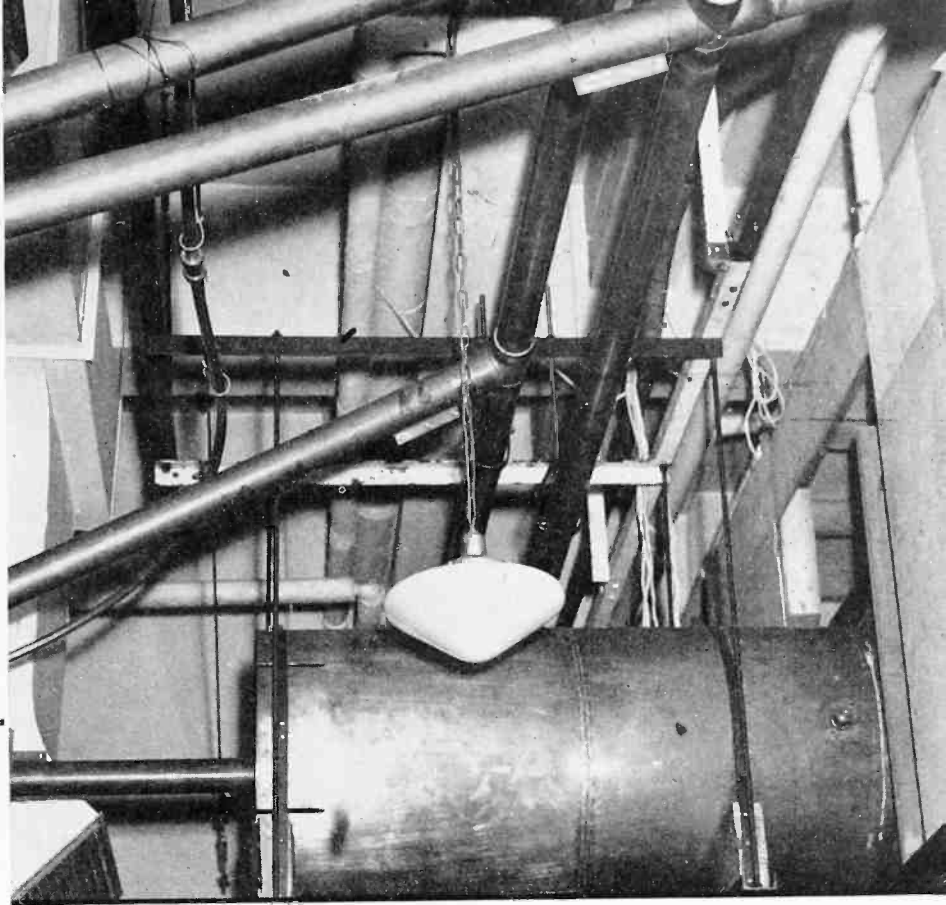

Retuning the sideband filter is a big job. Above are shown part of the coaxial elements used to place a "notch" in the output frequency curve of the transmitter. The bulky impedance matching drum, lower center, is another "plumbing" job for the Empire State television engineers

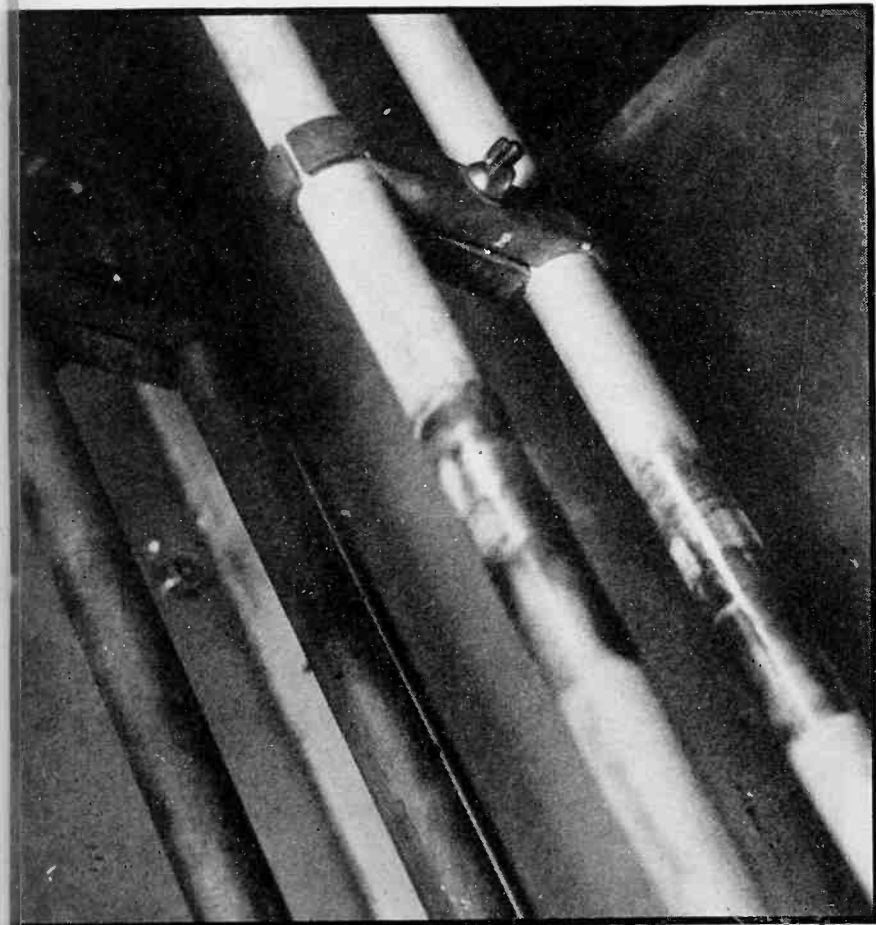

Above is shown one of the transmission-line type tank circuits, whose shorting bar was shifted from the position at right of center to a higher point, thereby increasing the resonant frequency 6 Mc. Changes similar to this must be made in every one of the nine stages from crystal to the final power amplifier. The Empire State television engineers wish all the changes were as simple as these

The shift in television channel assignment necessitated a major operation on the single sideband filter. At the right are shown the center conductors of various coaxial elements which had to be cut to new lengths (fortunately shorter because of the increase in frequency). Several cut-off sections are shown at the left center

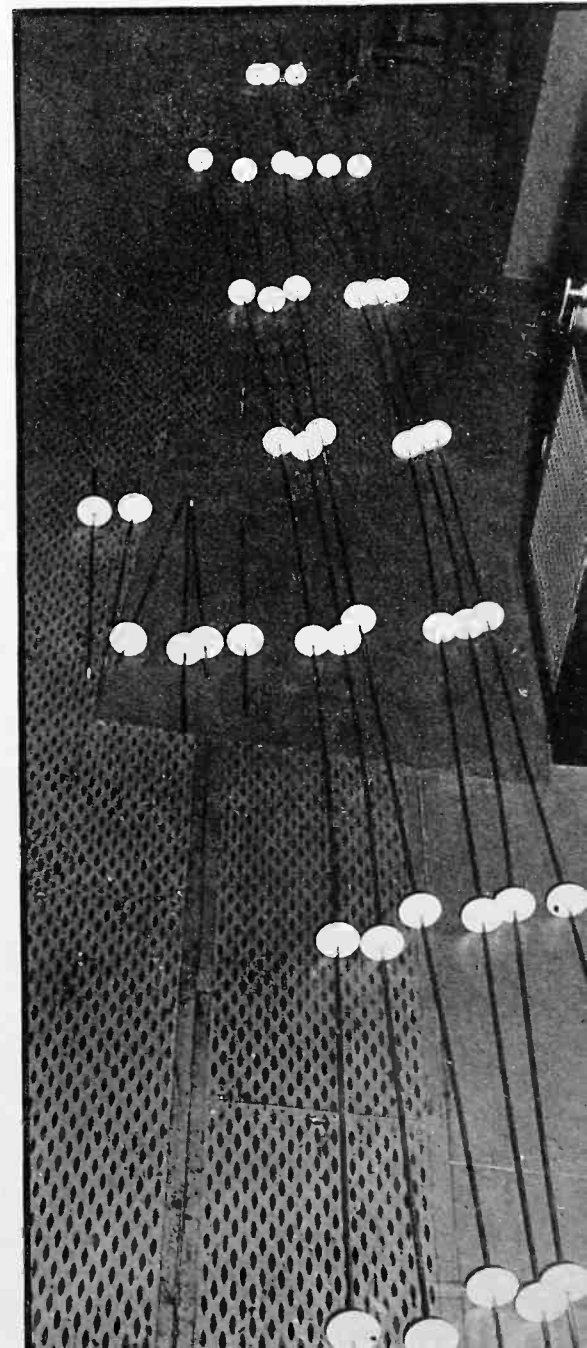

Revamping the sound radiator involved complete dismemberment of the individual elements, cutting out a section of each and welding the remaining parts together. At left is one of the four elements of the sound antenna showing the four points at which welding was necessary

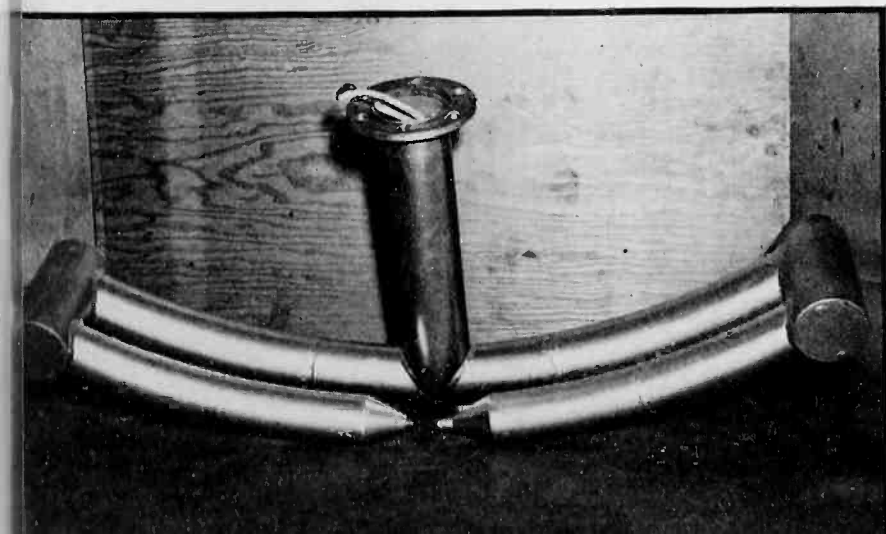

Design and Application of X-RAY TUBES



Fig. 1—Radiograph of a lily taken with 5000-volt Grenz rays

X-RAY TUBES

By ZED J. ATLEE

General Electric X-Ray Corp.

tional to the current flow across the tube as well as the atomic number of the element being bombarded. Also, the x-ray intensity varies inversely as the square of the distance, exactly as light, and increases with about the square of the voltage. From these variables the following equation can be made to express x-ray quantity:

$$Q = \frac{I \times V^2 \times \text{Atomic No.}}{d^2} \quad (1)$$

The minimum wavelength³ of radiation produced, which is a measure of the penetrating power of the x-ray beam, is expressed by

$$\lambda_m = \frac{hc}{Ve} \quad (2)$$

This can be reduced to the simple equation:

$$\lambda_m = \frac{12340}{\text{Volts}} \text{ angstroms}$$

The quantity of radiation produced at the minimum wavelength is very small as compared to the energy distribution curve so that the effective wavelength is roughly the order of twice the minimum value.

Classification of x-ray tubes in their own family seems to be best accomplished on the basis of the voltage of operation, which as Equation (2) shows, is a direct measure of the wavelength or pene-

X-RAY tubes are used in a wide variety of applications, industrial as well as medical, and the number is rapidly increasing. The uses range from superficial skin therapy and x-ray photography of flowers and insects to the x-ray examination of steel sections as thick as five inches. The purpose of this article is to present a picture of the large number of x-ray tube types for this wide range of work.

X-ray tubes can be classified as high vacuum, high voltage, hot cathode,¹ two electrode tubes. They use pure tungsten filaments and operate emission limited, the current flow through the tube being controlled by filament temperature. In this manner the full voltage drop occurs between the electrodes and the electrons are accelerated to high velocities, producing x-rays by bombardment of the anode target face usually of tungsten.² The intensity of x-rays produced at a given voltage is directly propor-

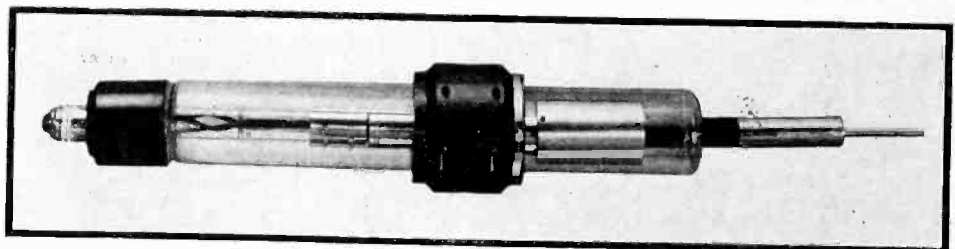

Fig. 2—Copper diffraction tube with four Lindemann glass ports

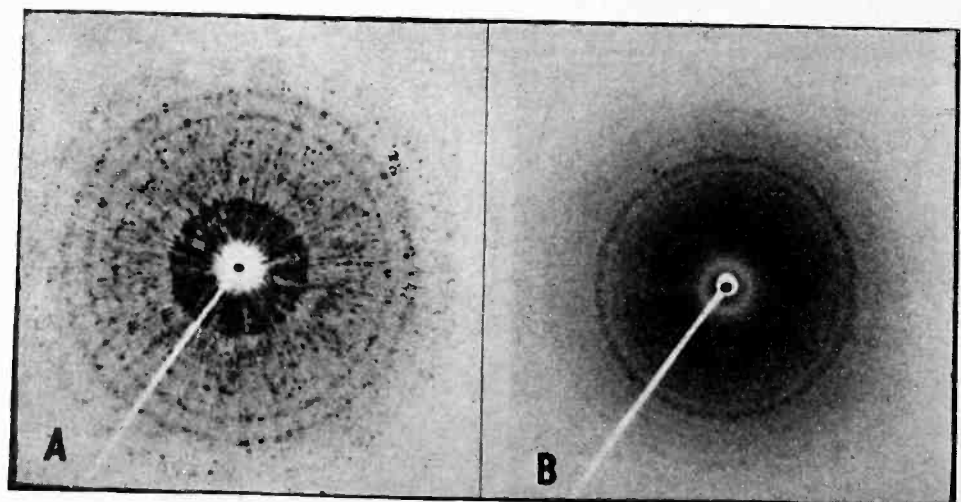

Fig. 3—Diffraction patterns of a clay in different states of activation. (A) Highly active sample (B) Inert sample

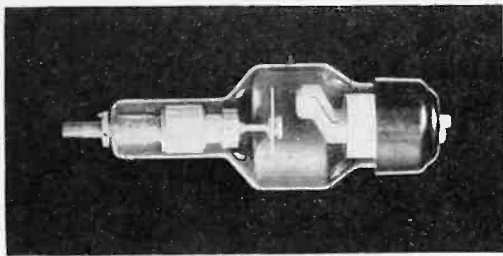

Fig. 4—Double focus rotating anode tube designed to operate at 3000 rpm. The anode acts as a target for only a small portion of the time permitting it to cool off during the remaining time. Thus, the permissible loading of the target is increased

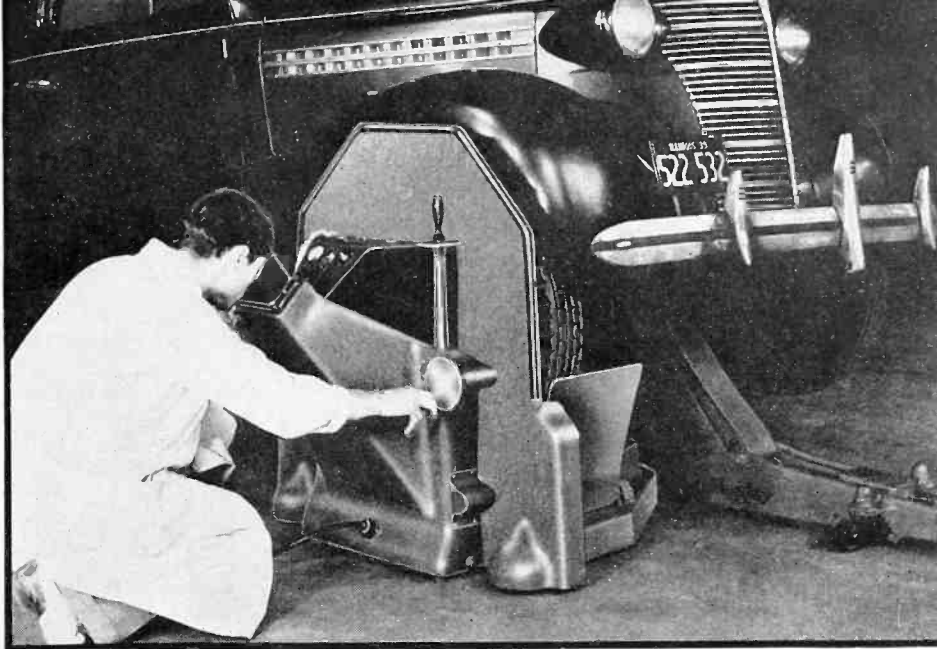

Fig. 5—X-ray apparatus for the fluoroscopic examination of automobile tires. A 65,000-volt tube is used

trating power of the x-ray radiation. The long wavelength threshold of x-rays extends into the ultra violet portion of the spectrum. These wavelengths are so long that such x-rays could be utilized only inside the vacuum tube because they would be completely absorbed by even the thinnest wall of low atomic number material.

Grenz Ray Tubes

X-ray tubes of the lowest voltage to be considered from a design standpoint are those to be used in the production of Grenz Rays, which are defined as "border line rays" or those produced at the long wavelength end of the x-ray spectrum. Such tubes operate at from 5 to 15 kilovolts, producing wavelengths of x-radiation of the order of 1 to 10 angstroms. The major problem in the design of such tubes is absorption by the envelope. All ordinary glasses have too high an absorption to x-rays of these wavelengths, and even pyrex glass, which has the lowest absorption of all the commercial glasses used in the vacuum tube industry, can be used only by making extremely thin that portion of the envelope through which the useful beam of x-rays is to be transmitted.⁵ The ideal window material for such tubes is Lindemann glass which is a lithium borate beryllium oxide glass, having no element higher in atomic number than oxygen, which is 8. This glass in the past has been very unstable, being extremely hygroscopic and has a

fixed melting point, thus making it very difficult to use. A stable Lindemann glass is now available and is being used in x-ray tubes for crystallography to be described next.

The application of Grenz rays has been limited to use in superficial skin therapy. The future of this type of tube is difficult to predict, but several applications may be forthcoming. Among these are extremely low voltage radiography of flowers, insects, botanical specimens, etc. Figure 1 illustrates the

type of radiograph which can be obtained, and which, if nothing else, possesses artistic value.

X-Ray Tubes for Crystallography

Next, in spectrum order, to tubes for Grenz ray production are those for crystallography or diffraction. These operate at voltages from 20,000 to 50,000 and utilize the characteristic radiation lines from the various elements.^{6,7} Such tubes using the K radiation from molybdenum, or greater atomic number

The x-ray spectrum, showing the fields of application which correspond to the applied voltage and target material used

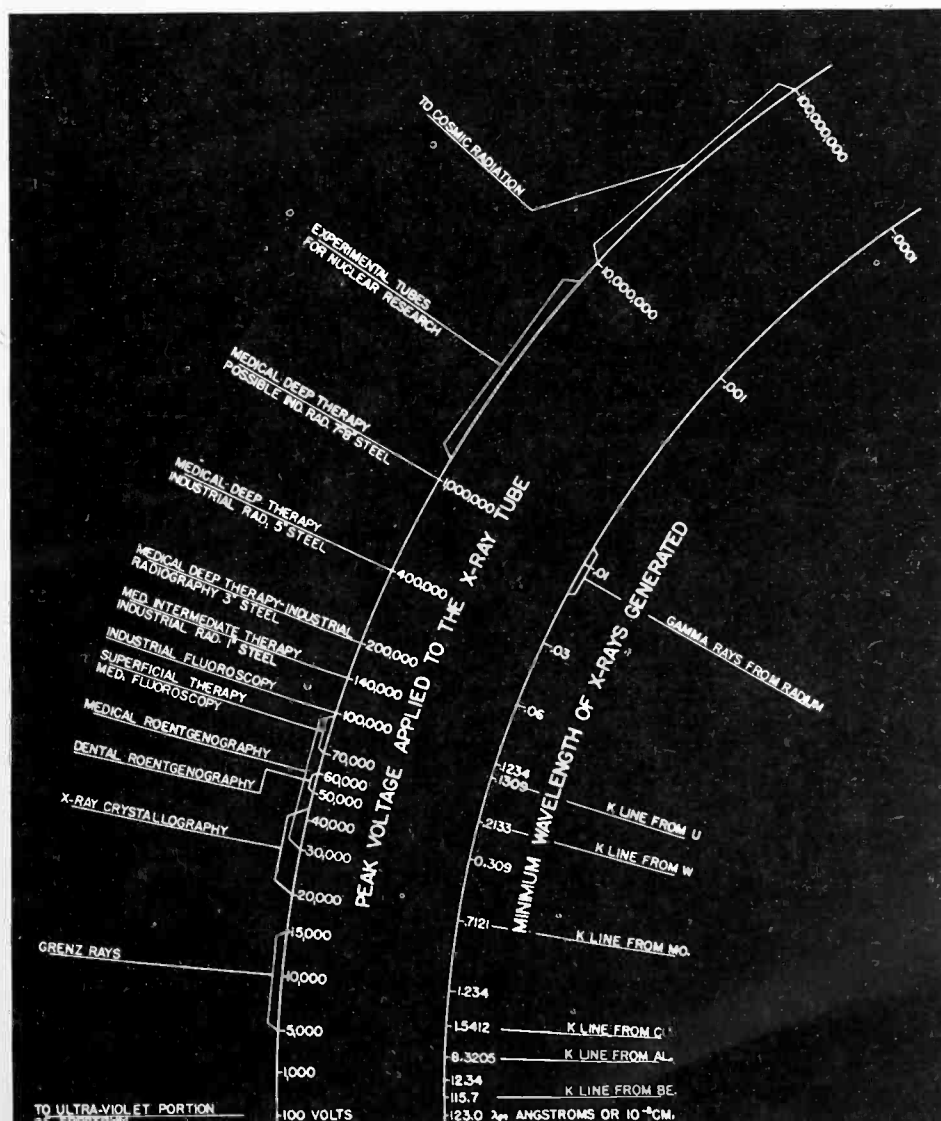

elements have been commercially available for many years. The wavelength of the K line of molybdenum is 0.712 angstroms, which is short enough to be readily transmitted through a pyrex envelope 1 to 2 mm in thickness.

In recent years, as x-ray diffraction has become commonly used, there has been increasing demand for tubes to utilize the K line of copper. Since this wavelength is much longer (1.5412 angstroms) the transmission through pyrex glass is negligible and we have the same problem as discussed under Grenz Ray tubes. Tubes operating on a continuous evacuating system with windows of cellophane or thin aluminum foil for transmission of these long wavelengths have been made by institutions, and physical and chemical laboratories for a number of years.

For several years sealed-off tubes with Lindemann glass ports produced in Germany and Holland have been available in this country. Last year the development of a similar tube was undertaken here and is now commercially available in a design as shown in Fig. 2. The essential features of the design of this tube are the 4 ports of Lindemann glass with internal shield to prevent electron bombardment, and the external shield of conducting bakelite to prevent corona deterioration of the windows. The standard form of this tube employs a copper target, but targets of a great variety of metals can be obtained. Because of the difference in melting point, vapor pressures, and heat conductivity, the ratings vary for the different metals as listed for the normal voltage of operation:

Target Material	Atomic No.	Wave-length of Alpha Line "K" Series	Current Ratings at 42,000 volts
Chromium	24	2.288	7 ma
Iron	26	1.936	8 "
Cobalt	27	1.789	8 "
Nickel	28	1.658	13 "
Copper	29	1.541	20 "
Molybdenum	42	0.712	25 "
Tungsten	74	0.213	25 "

Much can be said about the applications of these tubes in all branches of physical, metallurgical, and chemical work. X-ray diffraction studies of plastics, rubber, chemicals, metals, alloys, etc. are now commonplace and are rapidly requiring the use of more tubes

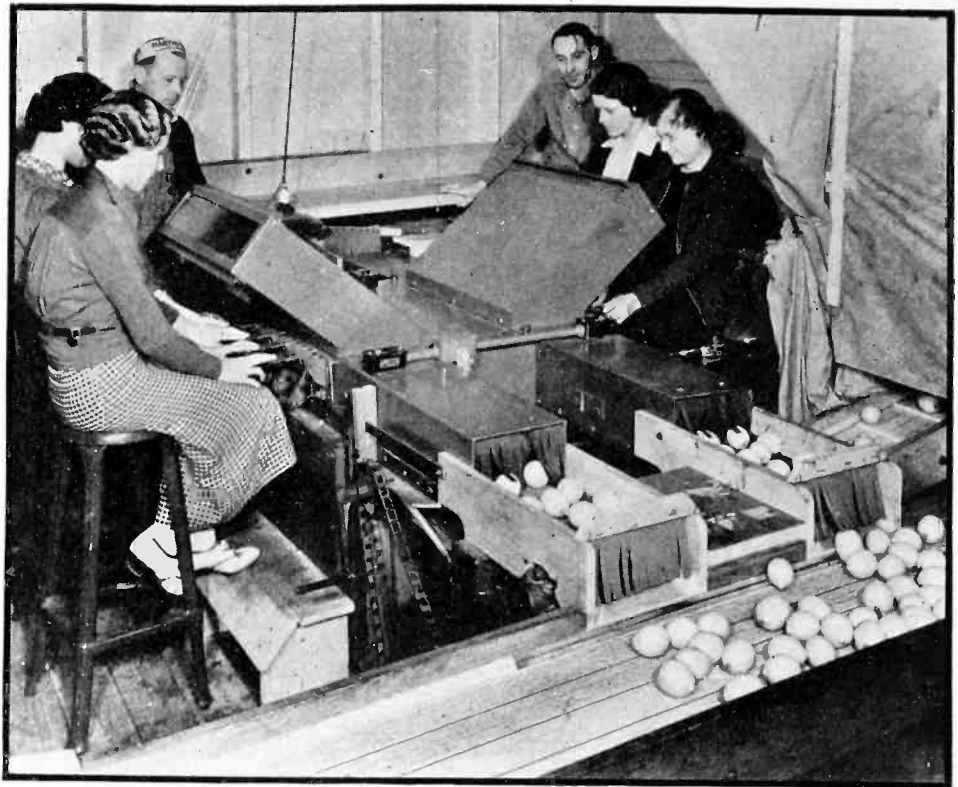

Fig. 6—Lemons undergoing fluoroscopic examination for crystallinity. The x-ray tubes used here operate at 100,000 volts and 10 ma continuously

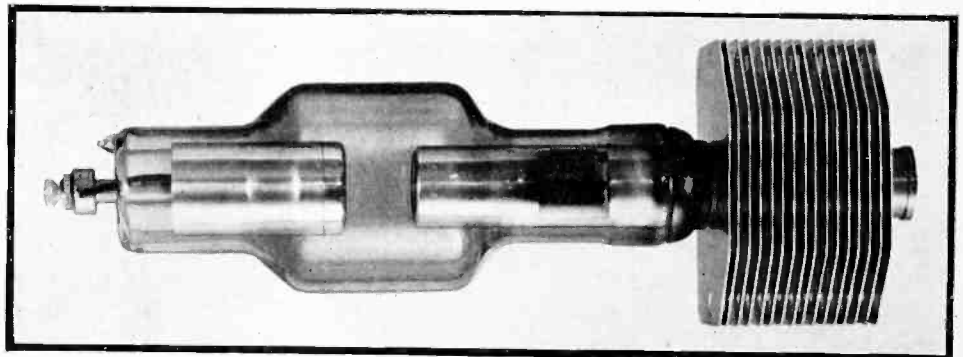

Fig. 7—Hooded anode, self-rectified x-ray tube for 200,000 volts. The large fins dissipate the heat generated in an oil bath

and apparatus. An example of this type of work is found in Fig. 3 which shows diffraction patterns obtained from a clay used in the refining industry for the decolorization of oils. The direct transmission patterns are of the same clay in different states of activation. Recent work of freezing greases, liquids, and other non-crystalline substances in liquid air or dry ice to provide a crystalline state while the x-ray diffraction pictures are being taken will extend this use into new fields. Interest in x-ray diffraction is being shown by the medical profession. Studies of bone, tissue, and secretions may reveal conditions otherwise impossible to detect. It is sufficient to say that the next ten years will see a great increase in the uses of x-ray tubes for diffraction and, of course, new designs of tubes will

be made to meet new techniques.

Roentgenographic tubes have a wide voltage range, from about 30,000 to 100,000, because of the widely varying thicknesses of the human body that have to be penetrated. X-ray tubes of this class comprise the largest volume of tubes built, as well as the greatest number of individual types. The principal problem of tubes for this application is the design for the production of the greatest intensity of x-rays from the smallest possible source. This problem is readily understood when one compares roentgenography to photography with a pinhole camera. The source of x-rays, or focal spot, compares with the pinhole. In order to obtain detail in such photographs, the pinhole must be very small. This lessens the amount of light and increases the length of time required

to obtain photographs. Similarly, as the focal spot size of an x-ray tube is reduced to improve the detail, the amount of x-ray intensity is decreased because of the limitation of energy per unit area that the anode target face can withstand. In the case of photographs, optical lens systems make possible more light, but unfortunately in the case of x-rays there is no such lens solution. Therefore, the problem of greatest intensity of x-rays from the smallest possible source divides itself into two design problems; one, anode target loadings; two, focusing the electron beam to accurate dimensions with good distribution.

The problem of target loadings is primarily one of choice of material for the target face. Tungsten, Atomic No. 74, is first choice because of its high melting point, low vapor pressure, high atomic number, fair heat conductivity, and availability in necessary shapes at low cost. There are very few elements that can compete with tungsten for this job. Gold, Atomic No. 79, would give 7 per cent greater x-ray output, but its low melting point and high cost would prevent its being a serious competitor. Rhenium, Atomic No. 75, has a slightly higher melting point than tungsten, but today sufficient material for a target would cost more than the rest

of the tube. Tantalum, Atomic No. 73, is the only metal that is available at reasonable cost, but it has a lower melting point and poorer heat conductivity.

Tungsten for the entire anode is too expensive, so that most tubes have tungsten targets cast in copper, which gives greater heat storage and greater heat conduction to the surrounding medium of air or oil. A tungsten target cast in copper, with a thickness of 3 mm, will stand a loading of 50 to 600 watts per square mm, depending upon such factors as time of exposure and size of focal spot.

The line focus principle⁸ is merely a geometric trick to increase the intensity of radiation in the projected focal spot. The target angle must remain great enough to give film coverage for the largest object to be radiographed, so that the gain permissible by this trick is limited. In case a 20 degree target angle, which is about a practical minimum for full coverage, a gain of 2.75 is obtained over a 45 degree target angle which would give a one to one projection.⁹

Double Focus Principle

Because of the great range of thicknesses to be penetrated, a wide range of x-ray intensities is used by varying voltage, time, current, and

distance. This means that the focal spot is not always loaded to its capacity. In order to improve detail on those radiographs requiring less x-ray intensity, smaller focal spots can be used. This fact has brought about the multiplicity of models of x-ray tubes having focal spots ranging in size, from one to five millimeters. The expense and bother to the doctor of several tubes is great and today double focus tubes¹⁰ of carefully selected combinations are being used.

Rotating Anode Tube

Since the loading per given area of tungsten target and available gain by line focus are limited, another principle must be resorted to for further improvement in radiographic detail. By moving a relatively cold target face past the electron beam, obviously the permissible loadings will be increased for a given focal spot area. This is most readily accomplished as illustrated in Fig. 4 by using a large tungsten face and rotating the anode at a high rate of speed. There are a great many interesting engineering and physical factors influencing the design of such tubes,¹¹ but they are too numerous to mention in detail here. X-ray tubes with rotating anodes have been manufactured in this country since 1936 and



Fig. 8—A million-volt x-ray tube. Multi-section construction is used to distribute the voltage gradient uniformly

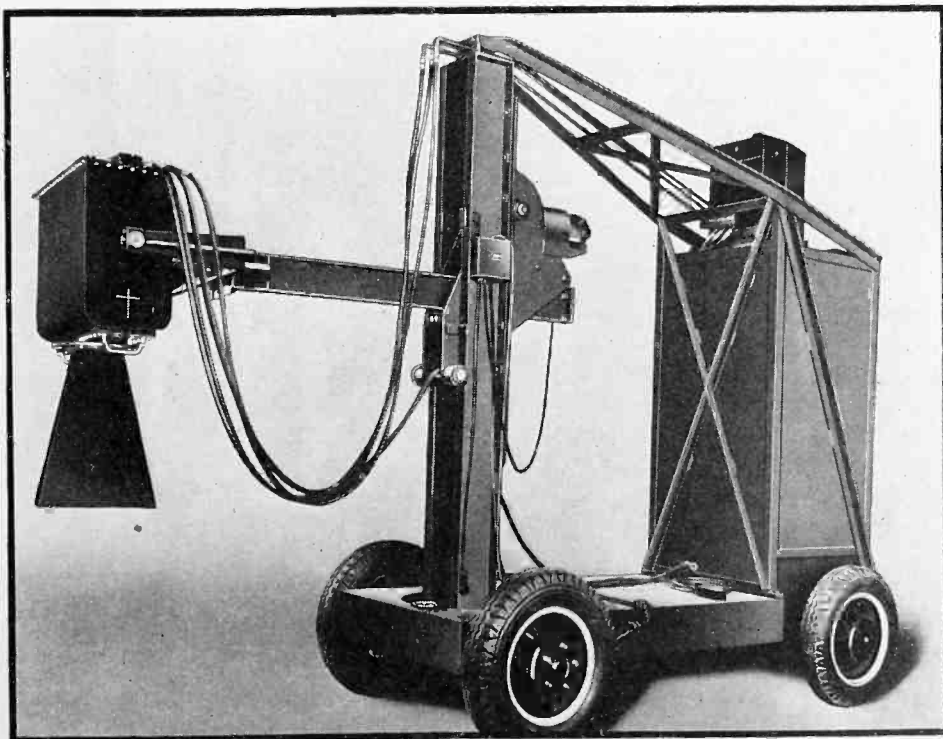
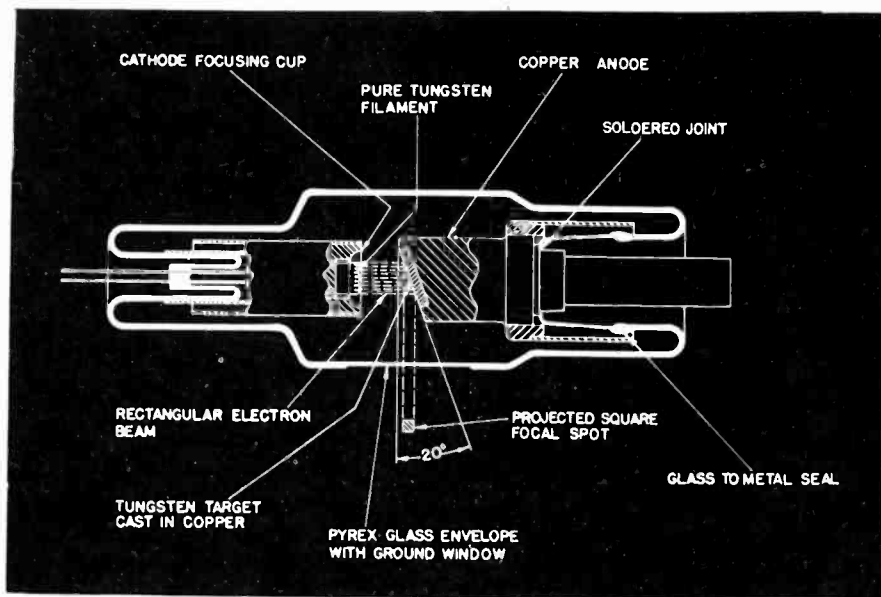

Fig. 9—Mobile industrial radiograph machine capable of penetrating 3 inches of steel. A 220,000-volt tube is used



Diagrammatic sketch of the line-focus type of x-ray tube which produces a square focal spot from a rectangular electron beam

today many radiologists are using them as a matter of routine.

The problem of electron focusing to obtain accurately defined focal spots, particularly in double focus tubes such as the rotating anode tubes, requires much design experience. Similar problems are present in cathode ray tubes, the essential difference being that the x-ray tube current requirements are 100 times as great, being as much as 1000 ma peak emission. Another difference is that in the x-ray tube focusing is accomplished without the use of a gun structure or electromagnetic focusing coils. Essentially focusing is obtained electrostatically by arrangement of the filaments in slots.

The importance of this application of x-ray tubes to roentgenography is realized by most of us. Today even the smallest hospital is equipped with complete x-ray facilities, and many doctors and dentists have their own. Nearly every organ in the body presents some particular type of roentgenographic problem, and new techniques and demands on x-ray tubes are constantly being called for.

X-Ray Tubes for Fluoroscopy

In addition to the roentgenograph, or x-ray film, x-ray shadows may be observed directly by using some material such as calcium tungstate or zinc sulphide that fluoresces when exposed to x-rays. Fluoroscopy, as this application of x-rays is called, is used extensively in medi-

cal practice and the same tubes used for roentgenography are satisfactory for this work.

Recently, industrial applications of fluoroscopy have been receiving considerable attention. Equipment for the examination of automobile tires to find defects and foreign material, such as tacks and nails, is now being commercially produced. Figure 5 shows such a unit, called the Tireoscope, in operation. The x-ray tube for this application is a standard tube designed originally for medical use and it operates at 65,000 volts and 3 to 5 ma.

An industrial fluoroscopic application that is much better established is the examination of packaged food products, candy, peanuts, etc. to detect foreign material such as pins, glass, and stones. Figure 6 shows such an x-ray unit installed for the inspection of lemons, valuable as a guide for rejecting those having crystallinity. The x-ray tubes used in this equipment are also standard roentgenographic tubes operating at a maximum of 100,000 volts and 10 ma continuously. The future of this field of application should be very good. As yet it has been limited to a voltage of 100,000, but there is every reason to believe that higher voltages will be used in the future.

X-Ray Tubes for Medical Therapy

X-ray tubes for therapy operating at voltage up to 100,000 are the same as those for roentgenographic applications. Above this voltage dif-

ferent problems of design are encountered. Tubes for 140,000 volts are the same as those for lower voltage except that the electrode spacing must be a little greater to prevent "cold-cathode emission." At 200,000 volts, the design of the x-ray tube is primarily one of high voltage engineering. X-ray tubes for this voltage were first made with a solid tungsten anode, and heat was dissipated entirely by radiation from this mass at a high temperature. Consequently, the current ratings were limited to the order of 6 to 10 ma. Increase in current ratings was first accomplished by Dr. W. D. Coolidge who designed an anode structure backed with a coil through which water could be circulated. Tubes of this design have gradually been improved and within recent years oil coolers have been provided to make possible shock-proof units for ratings of 200,000 and 220,000 volts at 20 to 25 ma.

Tubes now produced for high voltage operation have a thick-wall pyrex envelope to prevent the electron charges from rupturing the glass dielectric. Until very recently all of these tubes have operated from some type of rectifier circuit, but the demands for smaller, more compact units for this voltage range has brought about development of self-rectified therapy tubes. The operation of the self-rectified tube has necessitated new designs of tubes. The tube that will operate satisfactorily with a rectifier does not operate self-rectified because the electron charges on the wall give trouble on the inverse half of the cycle. By making a hooded anode structure, the scattered electrons reaching the glass envelope can be greatly reduced, thereby making possible excellent performance without the use of rectification. Figure 7 shows such a tube which has a rating of 200,000 volts and 10 ma without the use of a circulating oil cooler, heat dissipation to the oil being obtained by use of a large fin structure.

A tube of this general structure, but of larger physical dimensions is also being used extensively at 400,000 volts and 5 ma continuously. Today the top voltage of sealed-off x-ray tubes is 400,000 volts, but higher voltages will be successfully
(Continued on page 62)

U. S. C. G. Emergency Truck

—Ready for Anything

The latest addition to the emergency equipment of the Coast Guard is this mobile emergency outfit equipped for weather reporting, fire-fighting, ambulance service—all coordinated by two-way radio



For maintaining contact with other Coast Guard units, such as the amphibian plane shown here, the truck is fitted with a 20-foot telescopic radio mast and two powerful transmitters which can be used simultaneously

For handling the injured, two stretchers may be accommodated on the benches on either side of the gasoline generator. The truck is expected to prove of great value in flood-rescue work and for assisting in rescues at sea



Inside the truck is the radio operator's position, complete with two transmitters and receivers (one spare, although both may be used on different frequencies simultaneously). A full set of weather-reporting instruments is also carried

Power for the radio equipment is supplied by a gasoline-driven generator set. Room has been found for axes, shovels and extinguishers for fire-fighting purposes. Every effort has been made to fill the space with essential equipment

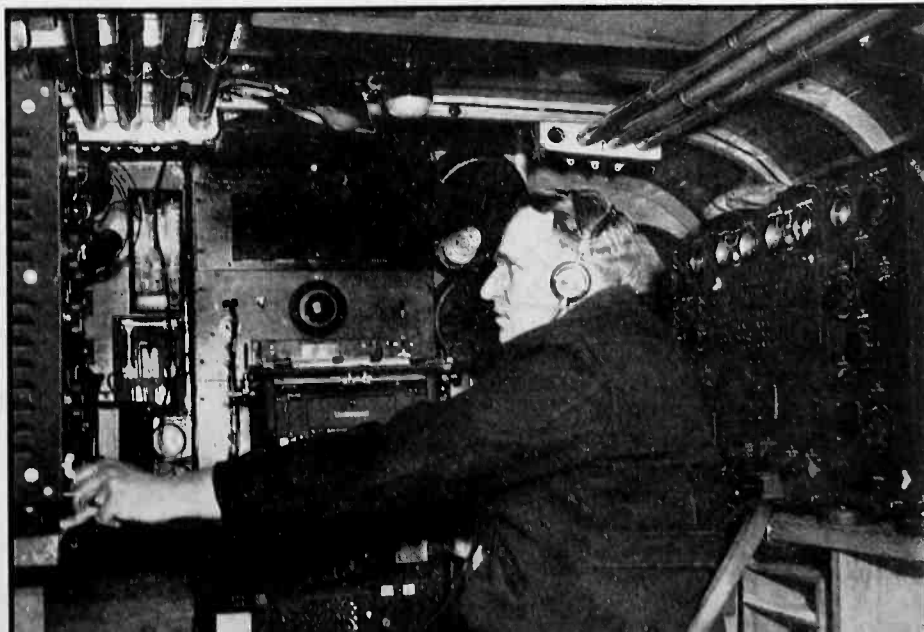

Color Television

Demonstrated by CBS Engineers

Old color-movie filter disc principle modified and adapted to television by P. C. Goldmark and his staff. Excellent results obtained from color-film pick-up, producing 343-line images at 120 fields per second on standard channel width

ON September 4th, television in natural colors was demonstrated to members of the technical press by engineers of the Columbia Broadcasting System in New York. The results were impressive, even startling to the uninitiated, although certain limitations were pointed out by Dr. Peter C. Goldmark, in charge of television engineering. These limitations were in his opinion either counterbalanced by the addition of color to the picture or else were removable by employing a more sensitive pick-up device in the camera. The system employed is based on a technique old in the modern picture art, but refined and adapted to television in several important particulars by Dr. Goldmark and his staff. The reproductions had all the color values, so far as could be determined by visual inspection, of the Kodachrome color film from which they were transmitted.

Briefly the color television system

employs a standard camera tube (in the demonstration a Farnsworth image dissector tube was used), a standard television channel, and a standard white-screen picture tube having higher than usual brilliance. Color is introduced by employing rotating discs containing red, green, and blue color filter segments, one disc placed in front of the camera and one in front of the picture tube. These discs are rotated synchronously at such a speed (actually 1200 rpm) that the light entering the camera during successive scanning fields passes through successive filter segments. Thus during a given field, only red light enters the camera, during the next field only green light, and during the third field only blue light. At the receiver, the light emerging from the picture tube screen passes through filter segments of corresponding color during the corresponding scanning fields. The rate at which the fields

follow one another is fast enough (actually 120 per second) so that the color impressions blend in the mind of the observer and an accurate tri-chromatic reproduction is obtained.

Since three separate color impressions are sent, it might appear that three times as many pictures must be transmitted in a given time as would be necessary for black and white pictures. But such a three-to-one ratio was found unnecessary. Actually the rate of sending pictures was increased by a ratio of only two to one. The progression of scanning and color impressions is shown in the accompanying diagram. The scanning fields are sent at a rate of 120 per second, which is twice the rate used in the R.M.A. standard for black and white pictures. The interlacing is two-to-one, so that 60 complete frames are sent per second. In scanning one complete frame, however, only two

Dr. P. C. Goldmark, left, and J. N. Dyer of the C.B.S. television staff at the film-scanning equipment. The filter disc may be seen in front of Mr. Dyer's right hand

Dr. Goldmark with equipment for projecting images from colored slides. The image dissector is at the right. Kodachrome transparencies were used as subject matter

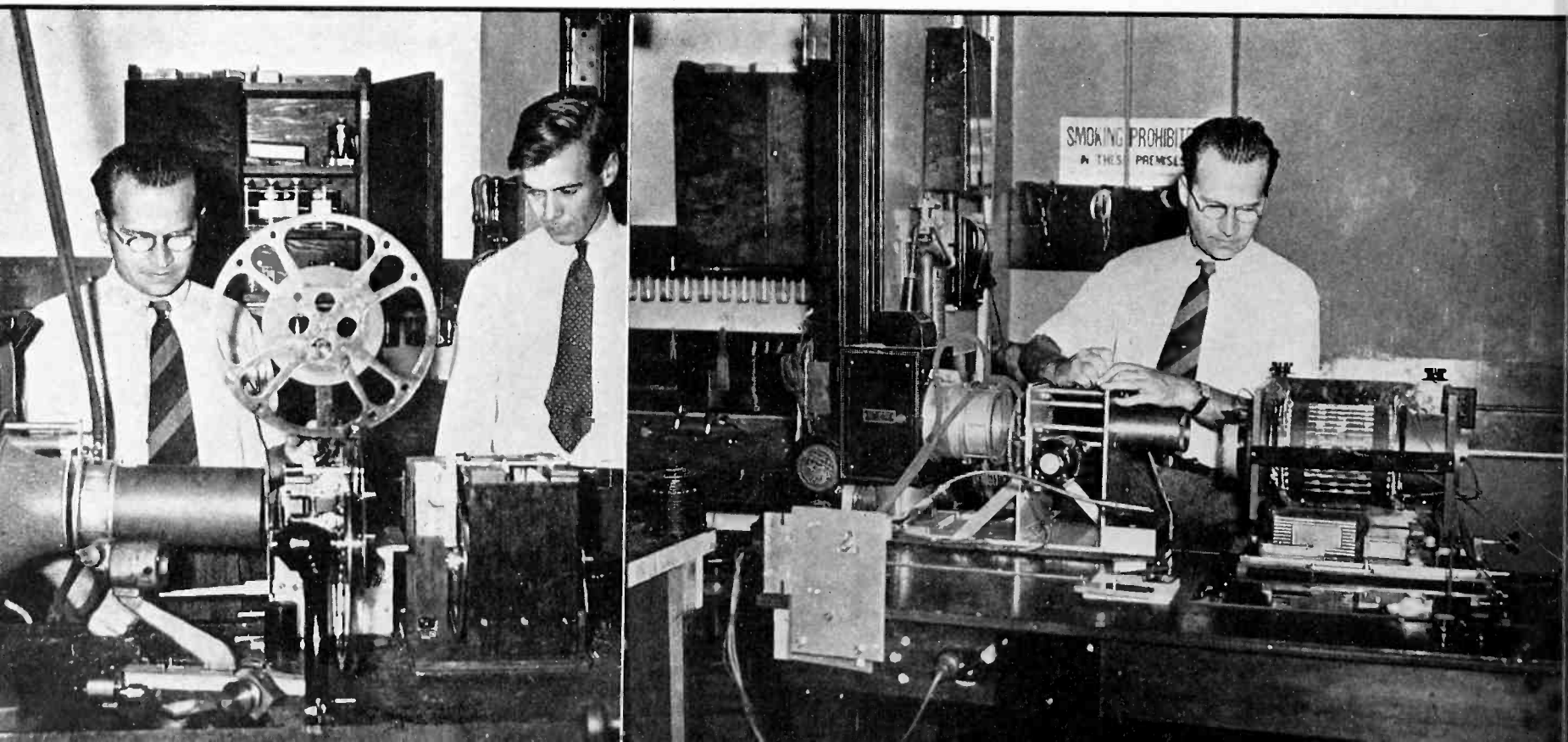

Time Interval	Scanning Field A ($\frac{1}{120}$ th Second)		Scanning Frame Field B ($\frac{1}{60}$ th Second)				Color Progression ($\frac{1}{40}$ th Second)			
	$\frac{1}{120}$ Sec.	$\frac{1}{120}$	$\frac{1}{120}$	$\frac{1}{120}$	$\frac{1}{120}$	$\frac{1}{120}$	$\frac{1}{120}$	$\frac{1}{120}$	$\frac{1}{120}$	$\frac{1}{120}$
Scanning Field	A	B	A	B	A	B	A	B	A	B
Color of Filter	Red	Green	Blue	Red	Green	Blue	Red	Green	Blue	Red

Table showing the succession of scanning fields and filter-disc segments. A cycle is completed in six fields, while each color is scanned every third field

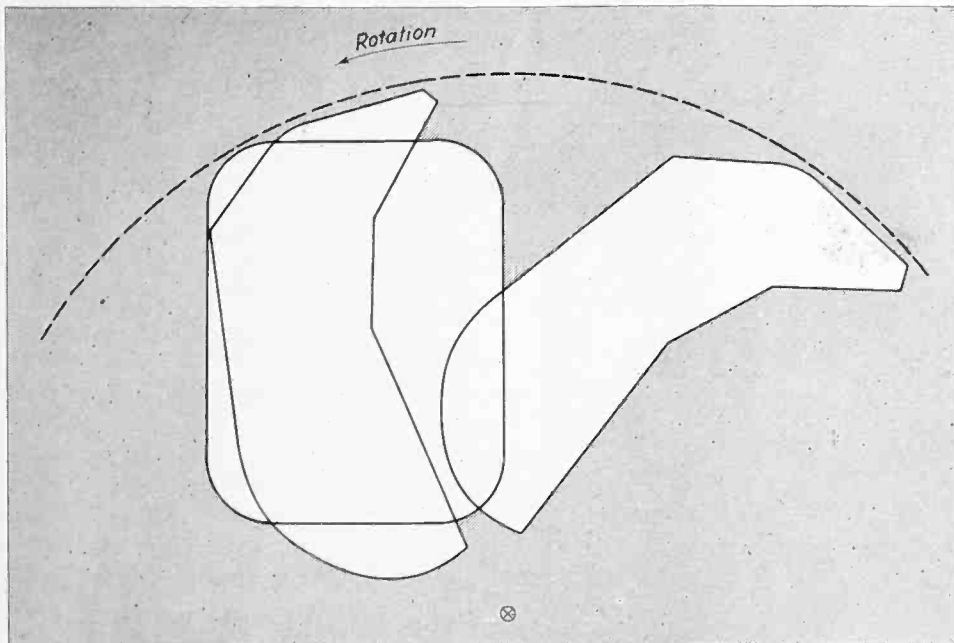

The shape of the colored segments on the filter disc at the receiver is chosen so that the light from the scanning spot has ample opportunity to decay before the segment passes by

of the color segments are employed. The third filter segment is employed on the next field. Then the progression of color segments repeats itself as shown. At the end of six scanning fields, two complete color progressions have occurred, and the process then repeats itself. Note that a given scanning field, for example that containing the even-numbered lines, is scanned through a given filter segment, say red, 20 times per second, but that the effective frame repetition rate, so far as scanning is concerned, is 60 per second. Since this frame-repetition rate is higher than that of the R.M.A. standard, the representation of motion is smoother.

The over-all flicker is also correspondingly reduced. However, if a portion of the picture is a solid color corresponding to that of one of the filter segments, the other two segments do not transmit light to the camera, and the flicker rate for that

particular color is 40 per second since the given filter segment passes in front of the camera that many times per second. This rate is high enough to avoid visible flicker even at a brilliance higher than would be ordinarily used in the home. On blended colors the effective flicker rates are higher, 80 or 120 per second, which are well above the critical range.

No flicker effects were noticeable at the demonstration, although a wide variety of pure and blended colors was shown, and the brilliance was adequate for viewing in the presence of illumination from overhead fixtures. Incidentally, the colored pictures show a remarkable resistance to the effect of external illumination, due largely to the fact that color contrasts are not effected so greatly as are simple black and white contrasts, when the picture is flooded with external light.

The immediate effect of increas-

ing the scanning rate by a ratio of two-to-one is to reduce the number of lines in the picture, for a given bandwidth, by a factor equal to the square root of two. Thus if a 441-line image is assumed for black and white, the number of lines for the corresponding colored picture is $441/1.41$ or 313. If 507 lines is assumed for black and white (this figure being closer to the optimum for the standard 6-Mc television channel), the color pictures have $507/1.41$ or 360 lines. For convenience, the CBS engineers chose the intermediate value of 343 lines. While any number of lines may be used, of course, depending on the bandwidth, the frame rate and on the relative degree of horizontal and vertical definition desired, it still remains that the colored pictures must have 41 per cent less resolution than the black and white pictures which can be sent over the same channel. It is the opinion of the C.B.S. workers, backed up by most of those who have viewed the demonstrations, that the addition of color more than counterbalances the loss of detail. In the first place the contrast of the color image is very greatly enhanced, since color contrasts are effective. But the principal difference is one of quality, since information is conveyed by color that cannot be conveyed in any other way. Hence the effective realism is very much improved.

A scheme developed by Dr. Goldmark to improve the detail for a given bandwidth involves quadruple interlacing. If a field rate of 180 per second is employed and the interlacing is four-to-one, the scanning frame rate is 45 per second. The reduction in detail relative to a black and white picture on the same channel is then only about 22 per cent. Such quadruple interlacing permits adequate rendition of the color progressions, excepting possibly the effect of interline flicker when a large patch of a solid pure color is to be reproduced. This might conceivably be a limitation, but one which could be taken care of by care in program technique and camera operation.

The Loss of Light in the Filters

Another important, and as yet inescapable, limitation is the loss of light due to absorption in the color filter segments. Measurements made

at C.B.S. show that the average light transmission efficiency of the filter disc is of the order of 30 per cent. This figure applies to the standard Wratten gelatin films used, number 25 for the red, number 47 for the blue, and number 58 for the green. To produce a given output signal from the camera tube, therefore, roughly 3 times as much light is required for color as for black and white transmission. Unless the transmission efficiencies of the filters can be improved, the color system will always work under this disadvantage, but with the advent of greater sensitivity in pick-up tubes,

previously stated. For the time being, this fact limits the transmission to images picked up from colored motion picture film, through which sufficiently concentrated light can be directed to produce a satisfactory signal. Before direct pickup of live talent subjects can be accomplished, the system must be used with storage-type camera tubes. Practical methods for so doing have been devised, and the required equipment nears completion.

One such scheme involves the use of an optical method of interlacing. The problem in using a storage-type camera tube is that no stored

sage through optically flat inclined glass plates which are attached to the filter disc, one plate after every second filter segment. This optical method of producing interlacing avoids the storage of charge between successive fields, while retaining the high sensitivity of the storage type tube. With the more sensitive type of storage camera tube, perfectly adequate pick-up of studio scenes under the light levels now used should be possible. For pick-ups under adverse conditions of illumination, the color filter could be dispensed with at the transmitter and a black and white image transmitted without any other change being required in any other part of the system. If flexible scanning circuits are adopted as standard in the system, it would be possible, if desired, to increase the detail of the image during such black-and-white transmissions.

Mechanical Details and Synchronization

At the transmitter a continuous motion-picture projector is used, which was operated in the demonstration at 60 frames per second, purely for convenience, although the standard rate of 24 per second can be used readily if minor mechanical and optical alterations are made. The filter disc, about 7.5 inches in diameter, is placed directly before the face of the image dissector. The disc itself has six filter segments, or two complete sets of red, green and blue. The shape of the segments is similar to that shown in the accompanying illustration. When a non-storage type of camera tube is used it is necessary only that the filter cover at any instant that portion of the image in the tube which is being scanned at that instant. The disc is constructed simply of an aluminum frame, which grips the gelatine filters. A protective plastic cover used in earlier work has been found unnecessary. The disc is driven so that the disc makes one revolution in 1/20th second, (1200 rpm) since this produces two color progressions of 1/40th second each, covering three fields of 1/120 second each, per revolution. The motor used in the demonstration was a 1800-rpm synchronous motor with a 6-to-4 gear reduction unit. The vertical scan-

(Continued on page 73)



At the press demonstration two receivers were shown, one producing images in black and white (at the left above), the other in color. Each receiver employed a nine-inch picture tube

the problem may not have any great practical importance.

The camera used in the demonstration was a Farnsworth image dissector. When infra-red light was removed by filters, the sensitivity of the pick-up was lowered to the point that noise was visible in the picture. At present the infra-red light is removed from the incident light because of the extremely high infra-red sensitivity of the dissector tube. Dissectors with improved color sensitivity characteristics are being produced. Experiments carried out with panchromatic storage-type pickup tubes, such as iconoscopes or orthicons, indicate that the light losses do not exceed two-thirds, as

charge can be allowed to "carry over" from one field to the next, otherwise part of the light received by the camera through, say, the red filter will be shown to the eye through the green filter at the receiver and the color values will be distorted. To avoid this effect, artificial pairing of the interlacing is introduced by any of the known methods (such as introducing a 60-cps square wave into the vertical deflection circuits). The scanning beam thus always passes over a line in the mosaic which has been discharged during the preceding scanning field. The image is displaced vertically on alternate fields by the width of one scanning line, by pas-

PROGRAM

ROCHESTER FALL MEETING

SAGAMORE HOTEL, ROCHESTER, N. Y.

November 11, 12, 13, 1940

MONDAY, NOVEMBER 11

8:30 A. M.

Registration

9:00 A. M.

Inspection of Exhibits

9:30 A. M.—12:00—NOON

Technical Session

Measurement of Electrode Temperatures of Tubes During Exhaust and Operation, A. D. Power, RCA Manufacturing Co., Radiotron Division.

Notes on the Use of Inverse Feedback in Electric Phonographs, Henry P. Kalmus and Dorman D. Israel, Emerson Radio & Phonograph Corporation.

Recent Improvements in Frequency Modulation Receiver Design, J. A. Worcester, General Electric Company.

12:30 P. M.

Group Luncheon—Main Dining Room.

2:00 P. M.—4:00 P. M.

Technical Session

The Role of the Limiter in F-M Noise Suppression, C. W. Carnahan, Zenith Radio Corporation.

The Application of Inductive Tuning to Ultra-High Frequencies, B. V. K. French, P. R. Mallory & Company.

A Phase Curve Tracer for Television, Bernard D. Loughlin, Hazeltine Service Corporation.

4:00 P. M.

Inspection of Exhibits

6:30 P. M.—8:00 P. M.

Group Dinner—Main Dining Room.

7:30 P. M.

Inspection of Exhibits

TUESDAY, NOVEMBER 12

9:00 A. M.

Registration

Inspection of Exhibits

9:30 A. M.—12:00—NOON

Technical Session

Annual Message of RMA Director of Engineering, Dr. W. R. G. Baker, General Electric Company.

Common-Channel Interference from Two Frequency Modulated Signals, H. A. Wheeler, Hazeltine Service Corporation.

Radio Tubes Today, R. M. Wise, Hygrade Sylvania Corporation.

12:30 P. M.

Group Luncheon—Main Dining Room.

2:00 P. M.—4:00 P. M.

Technical Session

The Coaxial Tuning Condenser, Frank W. Godsey, Jr., Sprague Specialties Company.

Television in Color, P. C. Goldmark, Columbia Broadcasting System.

A Study of Impulsive Noise in Frequency Modulation Receivers, V. D. Landon, RCA Manufacturing Co., Victor Division.

4:00 P. M.

Inspection of Exhibits

6:15 P. M.—8:00 P. M.

Fall Meeting Dinner (Stag)

Toastmaster—A. F. Van Dyck

Speaker—J. S. Knowlson

Subject—Engineers and Industry

WEDNESDAY, NOVEMBER 13

9:00 A. M.

Inspection of Exhibits

9:30 A. M.—12:00—NOON

Technical Session

Special Oscilloscope Tests for Television Waveforms, A. V. Loughren and W. F. Bailey, Hazeltine Service Corporation.

Extending the Range of Audio Reproduction, H. F. Olson, RCA Manufacturing Co., Victor Division.

The Kettle Drum Baffle, R. T. Bozak, Bozak Associates.

Improvements in High Fidelity Audio Frequency Amplifiers, Lincoln Walsh, Consulting Engineer.

12:30 P. M.

Group Luncheon—Main Dining Room.

2:00 P. M.—4:00 P. M.

Technical Session

The Evolution of a New Type of Metal Receiving Tube, D. W. Jenks, General Electric Company.

Discussion of Fluorescent Materials, B. F. Ellefson, Hygrade Sylvania Corporation.

Summary of the Significance of the Papers at this Meeting, Donald G. Fink, *Electronics*, McGraw-Hill Publishing Company.

4:00 P. M.

Exhibits Close.

An Electronic Method for

By L. A. WARE

The State University of Iowa

THE distribution curve of any varying quantity which can be translated into a rotating motion can be determined with the apparatus whose circuit diagram is described in this article. The circuit was developed for use in connection with a hydraulic flow meter, but its application may be extended to many other uses. For instance, a varying voltage or current can be made to operate a motor to provide the necessary rotational motion. The commutator shown in Fig. 1 may be directly connected to the motor shaft or it may be geared, up or down, to provide a speed suitable for this instrument. A typical distribution curve of the flow of a liquid obtained with this instrument is shown in Fig. 2.

Description of Apparatus

The hydraulic current meter is provided with a commutator shown at *C* which makes contact from *O* to *A* and *B* brushes alternately. These brushes actuate a delay circuit made up of V_1 , R_1 , C_1 , *O* and *B* and also a short circuiting branch through R_2 and *A*. This delay circuit is connected through a biasing cell V_2 to a full-wave grid controlled rectifier as shown. The current flowing through the common branch of the rectifier operates a relay and counter.

Let it be assumed for the purpose of the description that the commutator being turned by the hydraulic meter is rotating at $\frac{1}{2}$ revolution per second in the direction shown. In order to be correlated with Fig. 3 let $V_1 = V_2 = E_0$, and the voltage on the thyatron plates be represented by V_p . The curve drawn in Fig. 3 and labeled V_p is to represent both thyra-

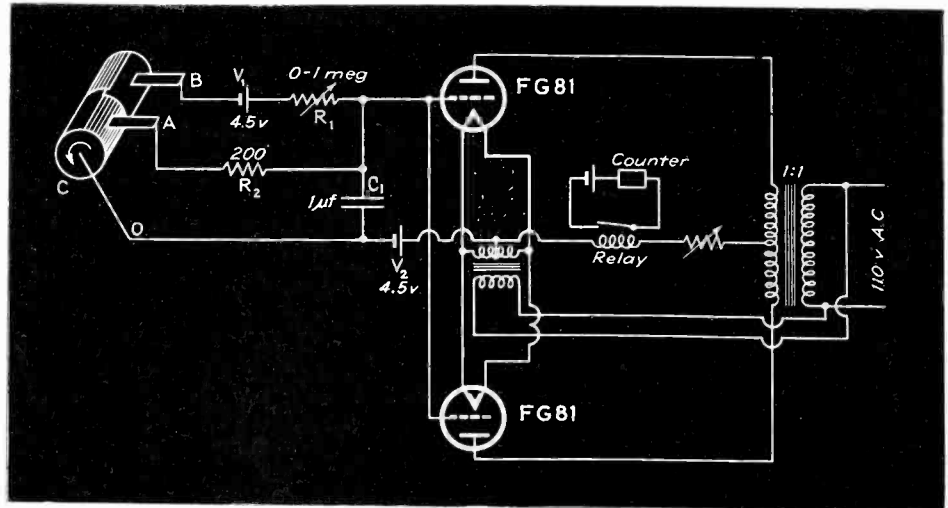

Fig. 1—Circuit diagram of apparatus for determining distribution curves of any varying quantity which can be represented by a rotating shaft

tron plate voltages so that it will be necessary to use only one firing characteristic represented by the curve relating E and V , E being the actual instantaneous grid voltage.

With the commutator in the position shown, the following conditions obtain. C_1 is short circuited through R_2 , and the potential of the grids is E_0 , hence no possible value of V_p on the plates will fire the tubes. This condition exists for about a half revolution when the circuit *AO* opens and *BO* closes. *BO* remains closed, according to our assumed speed, for one second. During this time the voltage across C_1 is building up along the curve below and to the left of Fig. 3 which relates the voltage on the grids to the time elapsed. The value of this voltage represented by the distance from O' to the firing line F is the voltage on the grid needed to fire the tube. This occurs after the time t' which is subject to a variation hereafter considered. If this time t' is very slightly less than the one second half period of the meter shaft then the firing potential is reached and the tubes conduct momentarily until the circuit *BO* opens. If the time t' necessary to

reach the firing grid potential is slightly longer than one second the circuit *BO* opens and circuit *AO* closes before the tubes fire, thus the half revolution is not counted. Thus it is seen that for this case the device will count all revolutions which require more than two seconds and will not count any periods less than this.

The time t' is under control by the adjustment of the resistance R_1 or the condenser C_1 . For a fixed value of C_1 , R_1 can be calibrated for various periods. Thus R_1 can be set at a given period T on Fig. 2 and the device operated for a certain standard period after which the counter is read giving a certain number N of revolutions in that time requiring a time longer than T . Thus a curve similar in shape to *A* of Fig. 2 can be plotted.

Error Due to the 60 cps Wave

There are two extremes for the time t' in Fig. 3. The voltage across C_1 will either reach the point x at the same time at which the plate voltage reaches the point y or the grid voltage will reach x a little late and will not cause firing until the next half cycle on the opposite tube as at y'' . The firing will not

Determining Distribution Curves

Fig. 3—Right, characteristic curves used in the analysis of the circuit of Fig. 1, showing 60 cps wave, thyatron firing curve and charging curve of condenser C_1

Fig. 2—Below, typical curve obtained with the instrument described. The instrument is set to indicate how many times within a standard period of time the rotating shaft turns at a slower rate than the set time (abscissa)

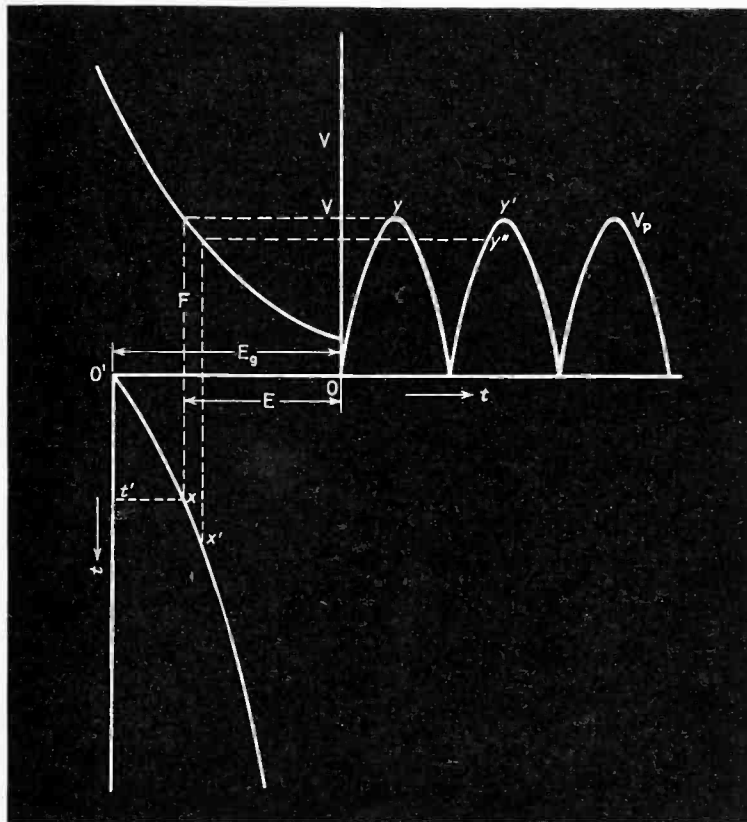
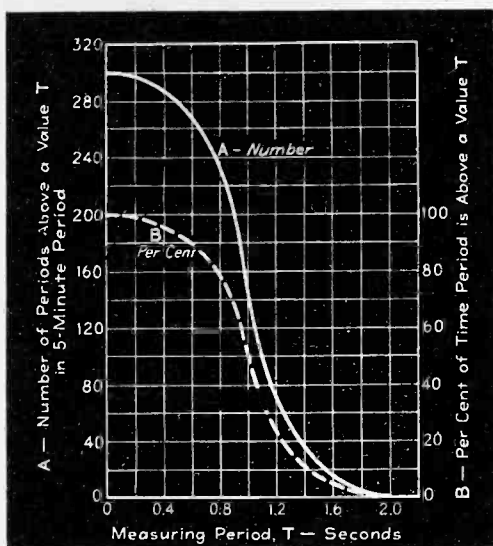

occur at y' because in the meantime the grid voltage has continued to increase to the point x' thus making possible a tube discharge at a lower plate voltage. The time represented by the interval between x and x' , or between y and y'' , is seen to be less than $1/120$ second. This interval is the maximum possible and would occur only when the plate voltage meets y and grid voltage meets x simultaneously. The probability of this is very small so it is seen that on the average the error due to this effect will be considerably less than $1/120$ second. Since the time intervals being measured are generally greater than $1/10$ second and since the method of calibration, being based on an average, makes only the fluctuation of this error of any consequence, it is not to be considered that the error is serious. This type of error is increased if the tube charac-

teristics are not the same. For that reason tubes with very similar characteristics should be used together.

Calibration is effected by connecting the electrical circuit to a motor driven commutator the speed of which can be easily measured. The commutator speed is then successively set at different values of T and the resistance R_1 set so that the counter just begins to operate. It is then set so that it just ceases to operate and the average of the two readings is the corresponding value of R_1 for the given value of T .

In measuring turbulent flow the R_1 dial is first set on a very low value of T and if a period of 5 minutes is used as standard as in the example represented by Fig. 2, assume that a total number of periods of 300 will be obtained in the 5 minute period. Next R_1 is set to a higher value of T and the counter

operated for 5 minutes. The table of readings might be as follows for the hypothetical case. (Standard period is 5 minutes.)

T Seconds	N Number of revolutions in 5 minutes
0.0	300 = N^1
0.2	298 = N^2
0.4	288
0.6	268
0.8	236
1.0	152
1.2	70
1.4	36
1.6	16 = N^n
1.8	4
2.0	0

Now assuming that the condition of turbulence is sufficiently stable and that the 5 minute period is long enough for a good statistical average the curve (of per cent of revolutions above a value T) plotted against T can be obtained by plotting N_n/N_1 against T_n . This curve is shown on Fig. 2 at B.

An Indicating System for High Voltage Power Packs

By R. L. HILDEBRAND

Westinghouse Electric & Manufacturing Co.

IN electrostatic precipitation systems (which use high-voltage power packs) it is important to incorporate a reliable indicating system since the installation is noiseless in operation and the results of its normal operation are not visible at a glance. The Westinghouse Precipitron, which applies the electro-

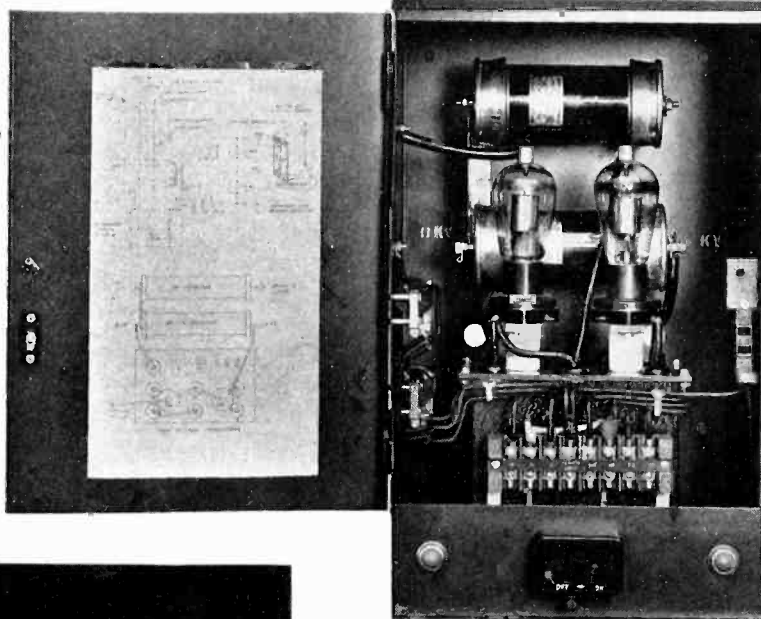

Fig. 2 (Above)—Power pack with door open. The relays used in the indicating system are at the left. Remote indication can be provided by additional pilot lamps

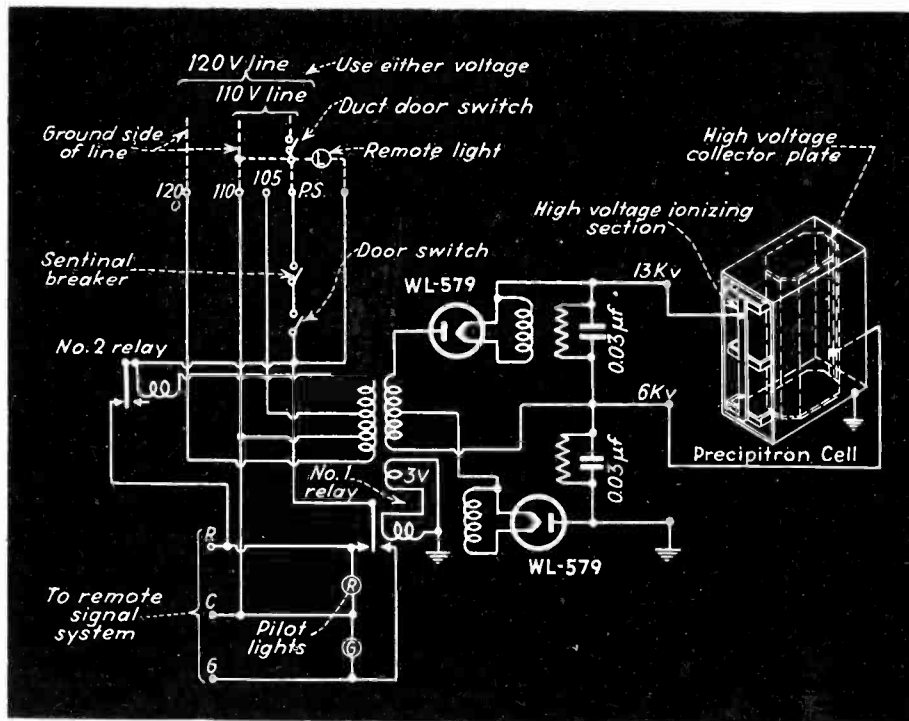

Fig. 1 (Left)—Circuit diagram of the high voltage power pack and indicating system. Relay 1 operates the pilot lights to indicate normal operation (green light) or short circuit (red light). Relay 2 lights red light in addition to green light to indicate an open circuit

static principle of air cleaning to ordinary ventilating systems, requires a power pack capable of supplying a load of 20 milliamperes direct current at 13,000 volts to the ionizing section and 6000 volts to the collector-cell section. These voltages are obtained by employing a modified voltage-doubling circuit consisting of a high-reactance transformer, two rectifier tubes and two capacitors connected as shown in Fig. 1. The power supply is shown in Fig. 2. The transformer supplies filament energy to the rectifier

tubes as well as the high-voltage energy which is rectified by the high-vacuum half-wave rectifier tubes and stored in the capacitors. The constants of the circuit are chosen so that a direct current having not more than 10 per cent ripple is supplied to the dirt-collecting units at normal load.

Each dust-collecting cell consists of an ionizing and collecting section. In the ionizing section the dust particles each receive an electrostatic charge as a result of passing through the highly ionized region

between wires and rods. The air stream carrying the charged particles then passes into the collecting section where the particles are removed by subjecting them to the pull resulting from the high uniform voltage gradient which exists between the parallel oppositely charged plates of the collector cell.

In normal operation the plates spark over occasionally and may become completely short-circuited if conducting material bridges the gap between plates. Such a short-circuit does not damage the apparatus because of the self-protecting feature of the high-reactance transformer. Nevertheless, it is important that such an inoperative condition of the apparatus be indicated at once. It is also essential to indicate faulty operation caused by defective rectifier tubes, open circuits or insulation failures.

One of the first schemes used to
(Continued on page 71)

Filter Design Charts—II

BY JOHN BORST

THE chart printed on the reverse side of this Reference sheet permits the user to find the elements of m-derived sections for low-pass, high-pass and band-suppression filters, when the values of the corresponding constant-k sections are known. A chart for determining the constant-k sections was printed on pages 35 and 36 of the August, 1940 issue. The present chart applies to series-derived as well as shunt-derived sections.

The range of the m-derived section chart has been purposely made short so as to permit accurate determinations of the L and C values. The scales marked LC_1 and LC_2 may be multiplied by any convenient factor when necessary, so long as the same factor is applied to each.

The chart is based on the fact that the m-derived elements are derived from the constant-k elements by multiplying or dividing by one of two factors: m or $4m/(1 - m^2)$. For this reason, two scales of m are employed. The given value of m is read on m_a (the left-hand scale in the center of the chart) for use when the equation contains m only. The value of m is read on m_b when the equation contains the factor $4m/(1 - m^2)$. The outer scales are marked LC_1 and LC_2 since they serve either as L or C scales. In using the chart, the same units are used in reading the LC_1 or LC_2 scales, for example both microfarads or both millihenries. Corresponding values of the constant-k element and the m-derived element are found by connecting the given value of the constant-k element and the given value of m (read on m_a or m_b) with a straight line. This straight line intersects the corresponding m-derived value on the opposite scale. The corresponding equations and diagrams of the sections are given in Figs. 2 to 4.

In the following, values with the subscript "k" are the constant-k values, whereas values with the subscript "1", "2" or "3" are the m-derived values. For low-pass filters, series-derived, connect L_{1k} on LC_2 scale with m on m_a , read L_1 on LC_1 . Similarly connect C_{2k} on LC_2 with

m on m_a , read C_2 on LC_1 . Connect L_{1k} on LC_2 with m on m_b , read L_2 on LC_1 . For low-pass filters, shunt-derived, use m on m_a , L_{1k} and C_{2k} on LC_2 , read L_1 and C_2 on LC_1 respectively. Using m on m_b , C_{2k} on LC_2 , read C_1 on LC_1 . For high-pass filters, series-derived, use m on m_a , C_{1k} and L_{2k} on LC_1 read C_1 and L_2 on LC_2 . Using m on m_b , C_{1k} on LC_1 , read C_2 on LC_2 . For high-pass filters, shunt-derived, use m on m_a , C_{1k} and L_{2k} on LC_1 , read C_1 and L_2 on LC_2 . Using m on m_b ,

L_{2k} on LC_1 , read L_1 on LC_1 . For band suppression filters, series-derived, use m on m_a , L_{1k} and C_{2k} on LC_2 , read L_1 and C_2 on LC_1 . Using m on m_a , C_{1k} and L_{2k} on LC_1 , read C_1 and L_2 on LC_2 . Using m on m_b , L_{1k} on LC_2 , read L_3 on LC_1 . Using m on m_b , C_{1k} on LC_1 , read C_3 on LC_2 . For band-suppression filters, shunt derived, find L_1 , C_2 , L_2 , C_1 as in band-suppression, series derived. Using m on m_b , L_{2k} on LC_1 , read L_3 on LC_2 . Using m on m_b , C_{2k} on LC_2 , read C_3 on LC_1 . The operations are indicated on the chart.

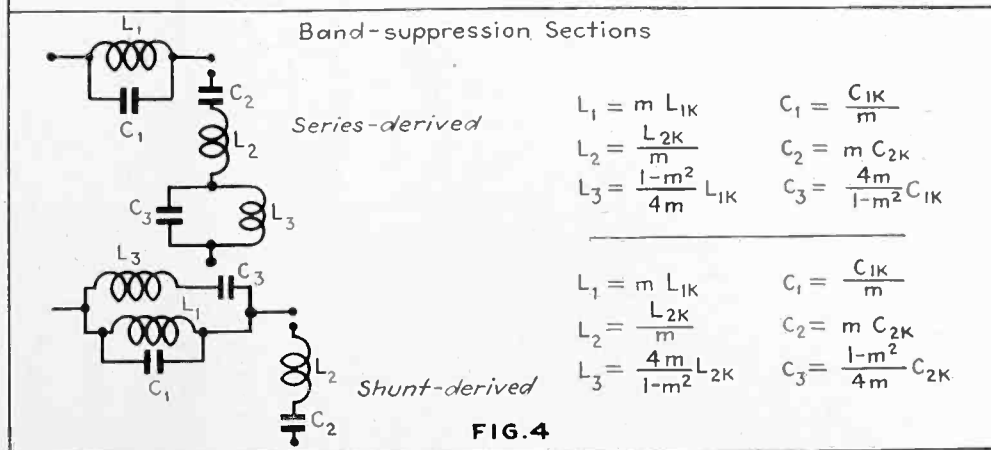
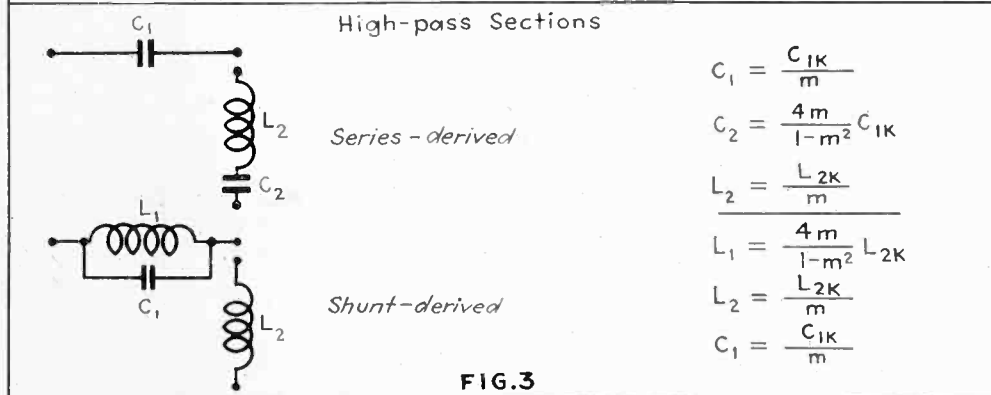
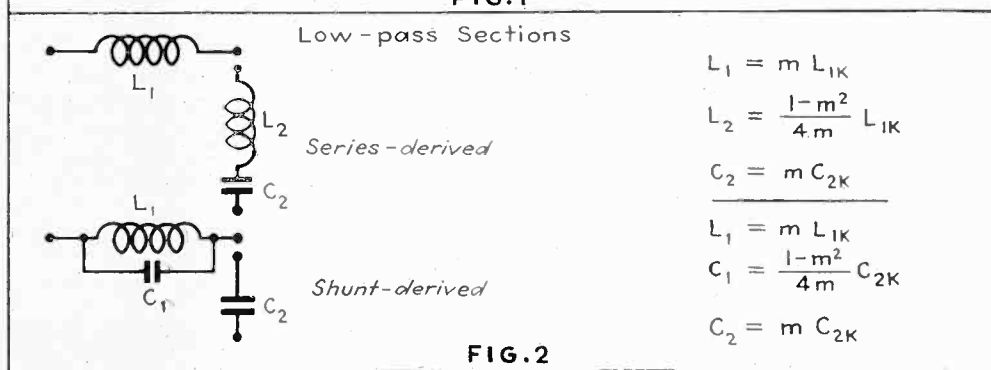
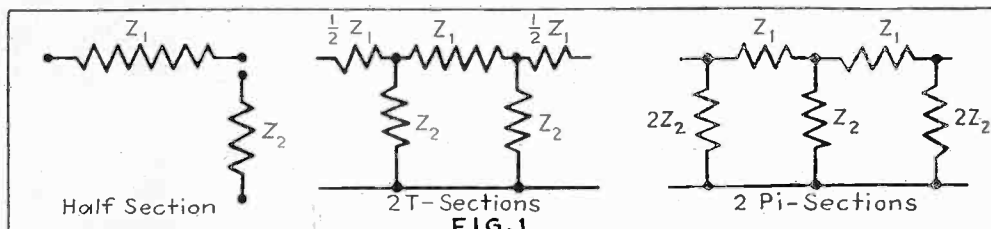

Filter Design Charts-II

By JOHN BORST

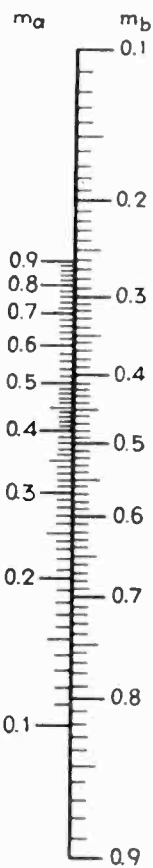
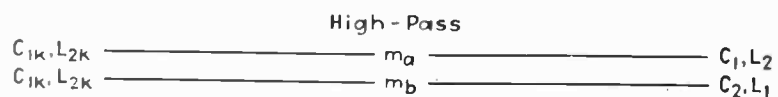
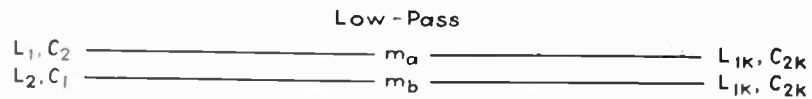
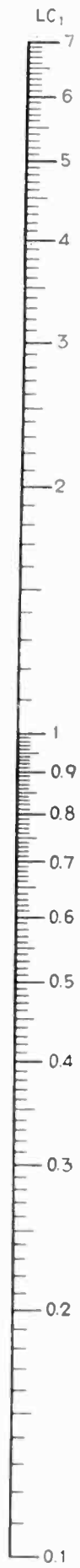

Band Suppression

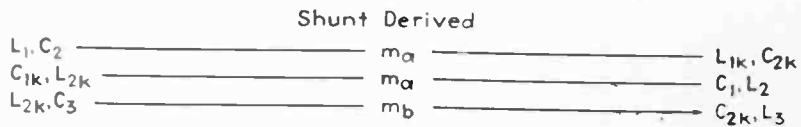
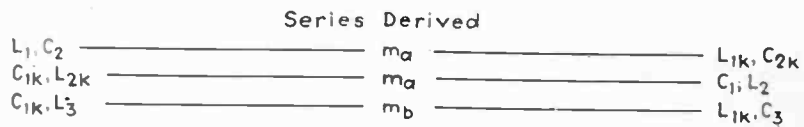

POSITIVE CONTACT

ONE LARGER PRONG FOR HEAVIER WIRE*



Voted BY USE the standard "shielded and grounded" socket



★ One contact in each socket is larger for polarization and for heavier wires.

CINCH dependable design and workmanship produced the real shielded plug; high protective collar having integral resilient spring for positive contact with shell. No chance for leakage. • Complete and compact. Consists of shell, and plug polarized with one larger prong. One-piece combination socket and ground spring; sockets and plugs supplied with two to five prongs. Each shell with curled edge . . . providing grip; protecting shielding fabric. • Rigid and sturdy; eliminates breakage . . . Flexible; adaptable for any shielded connection.

Cinch and Oak Radio Sockets are licensed under H. H. Eby Socket Patents

CINCH

SUBSIDIARY OF
UNITED CARR FASTENER CORPORATION
CAMBRIDGE, MASS.

MANUFACTURING CORPORATION
2335 W. VAN BUREN STREET • CHICAGO, ILLINOIS

New Books

Übermikroskopie

By MANFRED VON ARDENNE, *Julius Springer, Publisher, Berlin, 9W, 1940. Price RM 54.*

THIS BOOK ON ELECTRON MICROSCOPY deals with the construction and operation technique of such instruments as exceed, primarily in resolving power, the limits imposed by nature on optical microscopes. The detailed information contained in it, and the excellent diagrams and photographic reproductions, make it valuable to any electron microscopist or designer of electron microscopes. To a very large extent the contents of the book are derived from papers on subjects related to electron microscopy which the author has published in German technical journals during the past two years.

The book is divided, roughly, into sections dealing with electron microscope theory, construction of parts and accessories, design of the complete unit, preparation technique, and results so far obtained. After an introduction to the principles of electron imaging, the author describes the principal components of an electron microscope, electrostatic and magnetic lenses, electron sources and electron indicators for visual observation and permanent record.

Here follows an analysis of the imaging process and the origin of picture contrasts as a result of the scattering of the electrons by the object. The various aberrations are discussed in detail and summed up, reaching the conclusion that, with present means, the limit of resolution should lie close to 10 Angstroms for very thin objects. Questions of contrast and image intensity as related to resolution are considered further. Finally, the performance of the "electron probe microscopes"—the scanning and the electron and X-ray shadow microscopes—is studied in a similar manner. Their respective fields of effectiveness are indicated. Next, the permissible electron bombardment of the object and the possibility of observing living tissues are discussed. Proper magnetic shielding, suitable photographic materials, luminescent screens best adapted for visual observation, and X-ray protection are covered in the succeeding sections.

With the theoretical basis for the construction of electron microscopes established in this manner, the actual designs of the components of the electron microscopes—cathode system, lenses, object supports and airlocks,

and camera—and techniques for preparing fine apertures are given.

This instrument is provided with exchangeable lenses and apertures and is fitted for bright field, dark field, and stereo operation. Methods of preparing specimens for observation are described, including prescriptions for the preparation of extremely thin sections with a specially constructed microtome. Ways of measuring the resolution of an electron microscope and the technique of preparing stereoscopic electron micrograms are outlined.

The lengthy final section of the book deals with the results obtained up to now with electron microscopes. It is illustrated with pictures taken with the author's universal microscope as well as with the earlier Siemens instrument and the electrostatic microscope of the AEG. The subdivision, concerned with the application to physical, chemical, and technological applications, covers the representation of large organic molecules, colloids, dusts and smokes, dyes, catalyzers, or-

NOVEL COMMUNICATION SYSTEM



Archie Baxter using the interphone set in his trailer flying school outdoor "operations headquarters" at Floyd Bennett Field. The interphone connects the trailer with a small office he has in the airport Administration Building about a mile and a half distant. In this manner Baxter keeps in touch with what is going on at the airport

ganic polymerized compounds, photochemical reactions, surface structures, and fractures. In a second subdivision, (applications to biology and medicine) studies on viruses, bacteria, cell structures, and diatoms are reported and shown pictorially. The advantages of stereo representation are emphasized and the book is terminated by a plate of interesting stereo-micrograms. Apart from the decided one-sidedness of the presentation noted above, which may be regarded as the major defect of the book, and the inclusion in the text of numerous untested designs and methods, a number of minor errors are present.—V.K. ZWORYKIN, *RCA Manufacturing Co.*

• • •

Electrical Communication

By ARTHUR L. ALBERT, *Professor of Communication Engineering, Oregon State College, John Wiley & Sons, Inc., New York, Second Edition, 1940, 534 pages. Price, \$5.00.*

THIS IS ONE OF THE FEW BOOKS in which the entire communications industry is considered. As such it is valuable to those engineers who are engaged in work of a non-technical nature and want to have a broad knowledge of the technical side of the industry. Also, it will be of benefit to those men specializing in a particular branch of the art who wish to be acquainted with the other branches. Telegraph, telephone and radio systems of communication are described clearly and thoroughly, with greatest emphasis on the telephone. Radio communication methods are described to a considerable degree as they fit into the telephone picture. This, however, is not to be taken too seriously because the fundamentals remain the same regardless of the application.

The first chapter is concerned with the history of electrical communication and forms an interesting and valuable background for the remainder of the book. The next three chapters cover the fundamentals of sound and acoustics as well as the electrical fundamentals. The following two chapters are devoted to instruments for changing acoustical energy to electrical energy and vice versa. Transmitters, microphones, receivers and loudspeakers for both radio and telephone use are described. There follow chapters describing the circuits of telephone, telegraph and radio systems. Networks and electric wave filters form an important branch of the art and thus receive considerable attention here. Fundamentals of electronic circuits and their application in communication is discussed thoroughly. The book is well illustrated with many diagrams and a number of photographs. In a book so broad in scope, the author cannot discuss all of the subjects in great detail and therefore an extensive bibliography is provided. There are also a number of suggested assignments at the end of each chapter.—C.W.

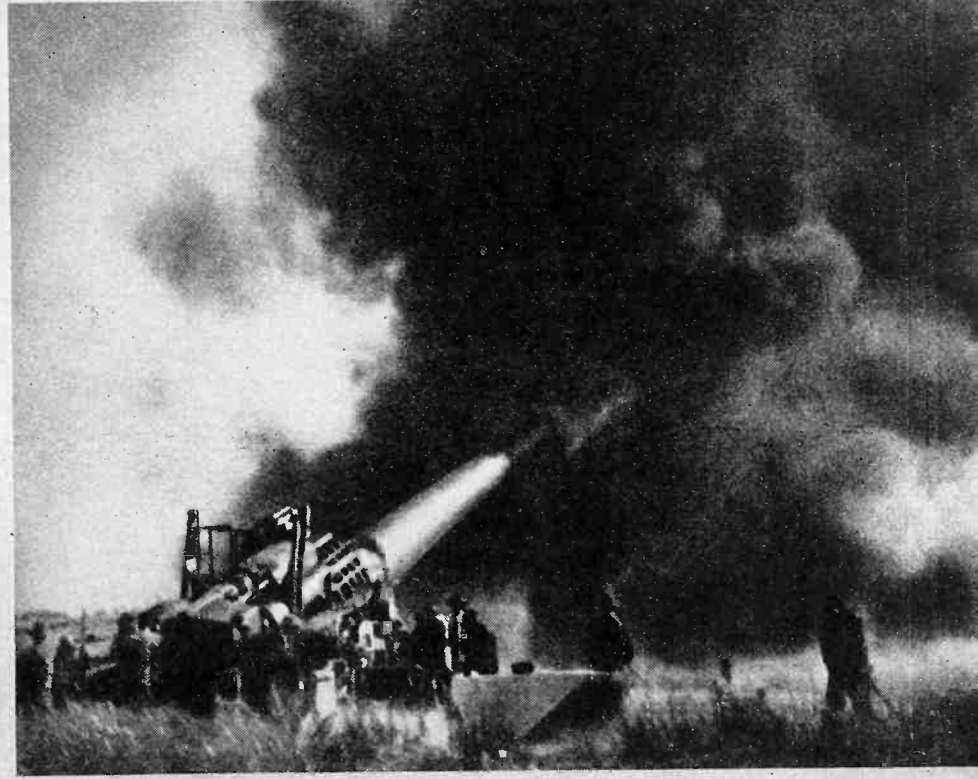
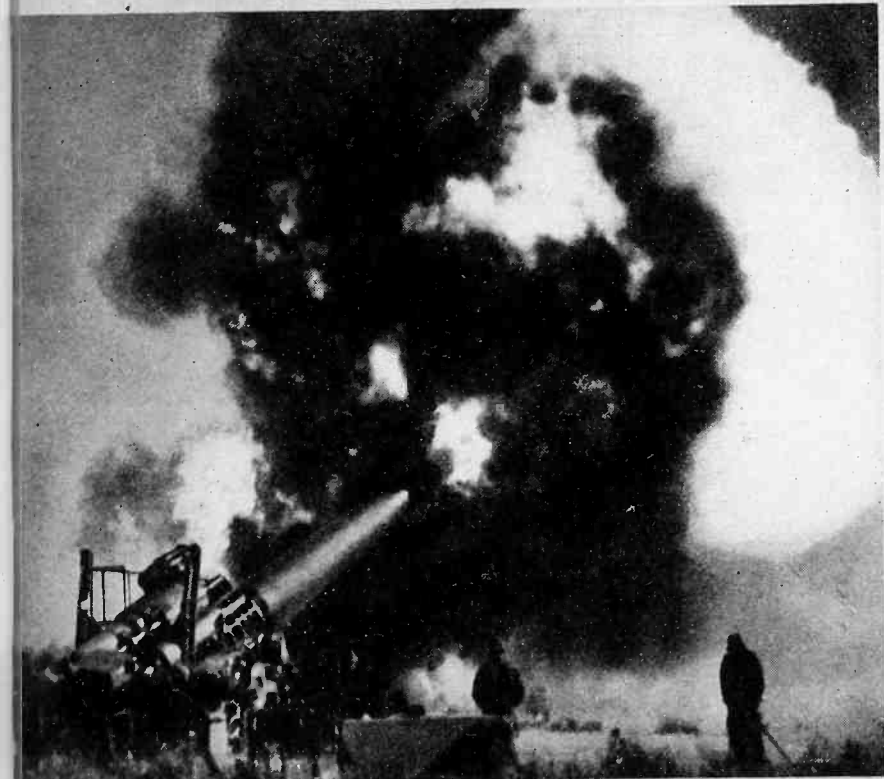
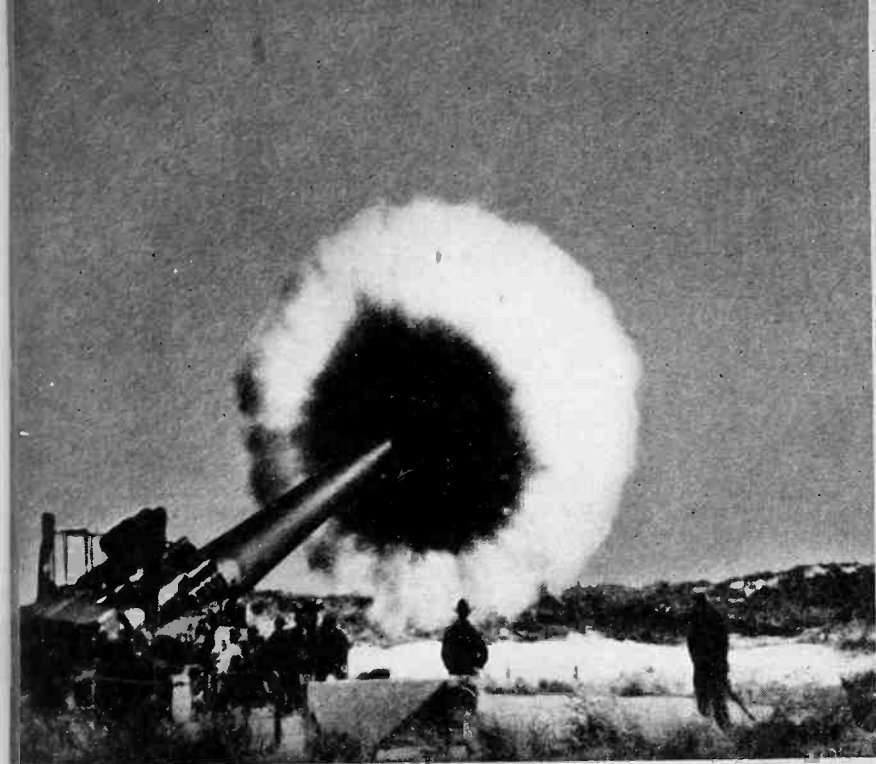

Insulation Tells Them When to Talk

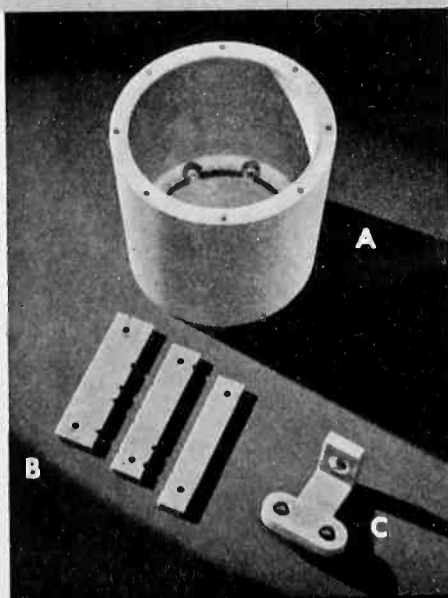

A—Detector Case, turned, threaded, bored, drilled, tapped and counter-bored.

B—Sawed and drilled insulators.

C—Filter bracket, sawed, milled

TRAINING, elevating and firing big guns afloat and ashore is a job for electricity and its inseparable co-worker—insulation. And in many types of gun control as in many electrical conveniences that prepare your toast, automobiles that take you to work, machines that tabulate your business figures—you'll find dependable Synthane Bakelite-laminated.

The uses for Synthane are not limited to electrical devices. Synthane has too many combined properties for that. It is a dense, hard, uniform, technical plastic, light in weight (about half the weight of aluminum), structurally strong, and resistant to solvents, gases, petroleum products,

many acids and salts. Synthane is also easily machined—or we'll machine it for you as we did for the three manufacturers whose products are shown at the left.

With all these properties—and more—Synthane is worth considering wherever any other material is limited in its properties, harder to machine or giving unsatisfactory performance. We invite you to send for "Technical Plastics in Industry", a folder showing how and where to use Synthane, and to use the services of our men, material and machines in improving your product.

SYNTHANE CORPORATION, OAKS, PENNSYLVANIA

SYNTHANE
Bakelite—laminated

TECHNICAL PLASTICS

SHEETS • RODS • TUBES • FABRICATED PARTS • SILENT STABILIZED GEAR MATERIAL

TUBES AT WORK

Application of feedback to lower distortion in recording amplifiers, a descriptive analysis of phase inverter circuits employing one tube, and a simple decade resistor set-up are the gist of the tube applications this month

A High Fidelity Recording Amplifier

BY I. J. ABEND

IN RECENT YEARS THE INCREASED INTEREST in instantaneous recording equipment and its associated fields, has been the cause for marked improvement and rapid development of high fidelity recorders and phonographs. The design of most of this equipment has been made with a view toward producing an inexpensive, but dependable unit, without sacrificing any of the qualities of the more expensive recorders of past years.

It is the purpose of this article to describe an amplifier with suitable characteristics, which may be used for both public address and recording. Before describing this amplifier which can be built for less than ten dollars, it is worthwhile to explain why such a unit must be designed primarily for recording. For recording, the variation of the impedance of the cutting head load cannot be neglected. For instance, a cutter rated at 15 ohms at 1000 cps was found to be three ohms at 100 cps and twenty ohms at 3000 cps. Thus an output transformer designed for a 6V6 tube to a 15 ohm load will reflect an impedance from the secondary to the primary of about

1000 ohms at 100 cps. This lowered primary impedance will give decreased output and high second harmonic distortion. If the impedance of the primary were higher than 5000 ohms, as the case would be at 3000 cps, then high third harmonic distortion is produced.

The design engineer can overcome this fault by doing one of four things. 1. Design a push pull output stage using beam tubes. 2. Design a push pull output stage using triode tubes. 3. Use a single triode output. 4. Employ inverse feedback.

The first remedy is more expensive and will not do its job efficiently because third harmonic distortion is not eliminated. The second remedy generally runs into a great expense. The third remedy will give second harmonic distortion on the low frequencies. The fourth remedy is the best and the simplest because it eliminates harmonic distortion and transient voltages, improves the frequency response of the output transformer, is not affected by any line voltage variation, and most important is very inexpensive.

An amplifier incorporating feedback has been designed by the writer for this purpose. The amplifier consists of four tubes, a 6SJ7, 6C8G, 6V6, and a 5Y3G. It has an overall gain of

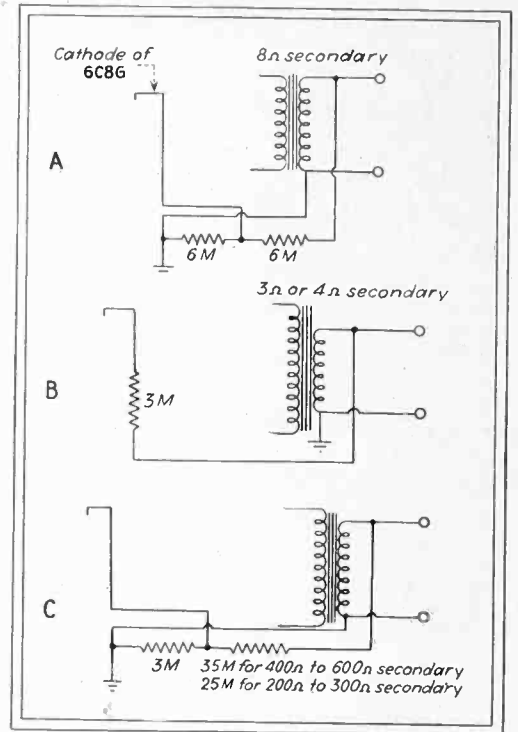

Fig. 2—Feed-back connections for different cutter impedances

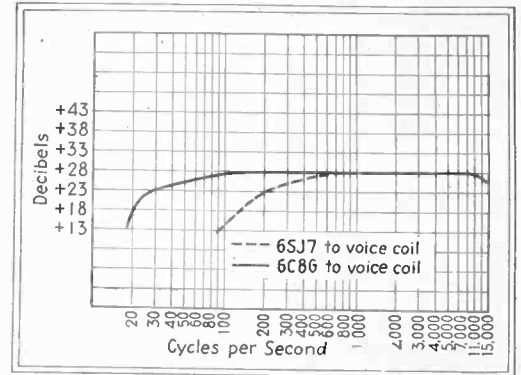

Fig. 3—Overall response with reduced gain at low frequencies

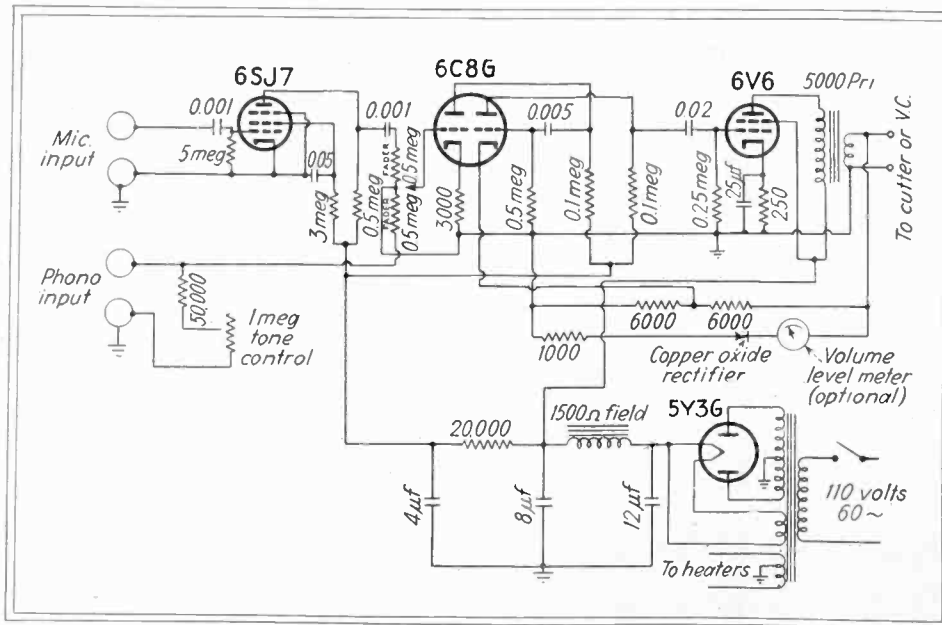
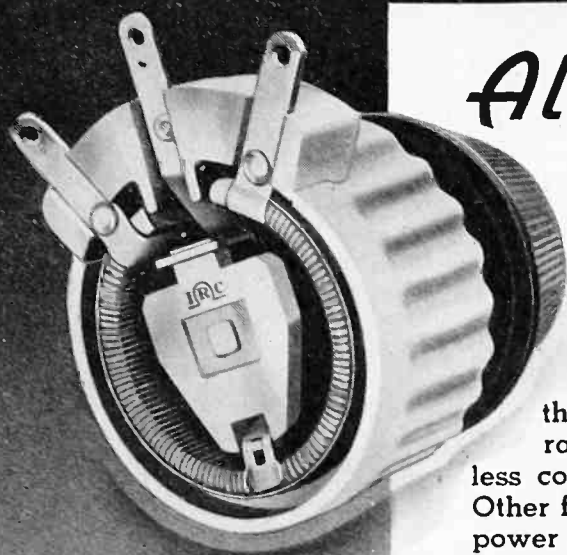

Fig. 1—Feed-back amplifier especially designed for driving recording cutters

102 db, a frequency response from the 6C8G to the secondary of the output transformer of 100 to 11,000 cps plus or minus one-half db, and is down 6 db at 25 cycles. For recording, the low frequency response has been purposely reduced in the 6SJ7 or microphone stage. This is done to reduce the amplitude vibration of the stylus in the cutting head, so as not to cause overcutting. If improved low frequency response is required the coupling condenser from the 6SJ7 can be changed from 0.001 μ f to 0.005 μ f. It is preferable to use a good twelve-inch speaker with this amplifier to reproduce music or speech with the highest fidelity. The speaker field may be either 1500 or 1800 ohms. If 1500 it is best to use a 5Y3G tube as a rectifier to keep the voltage down. If an 1800 ohm field is used, a 5Z4 rectifier may be used. The output transformer may be any inexpensive unit. A $\frac{1}{2}$ by $\frac{1}{2}$ inch core on the output transformer works very well, but the power transfer is poor. If all around good performance is wanted an output transformer with at least a $\frac{3}{4}$ by $\frac{3}{4}$ inch core should be used. The power

"DESIGNED-IN" RESISTORS FOR YOUR PRODUCT



All-Metal Rheostats for Faster Heat Dissipation

Enthusiastic reports from users indicate beyond question that, in All-Metal Rheostats, IRC engineers have produced an innovation which will work revolutionary changes as well as widespread economies in rheostat usage. So rapid is the heat dissipation of these units, it is impractical to rate wattages according to the old standard. Smaller, less costly rheostats can be used in many applications. Other features include the use of two separate springs for power and tension to avoid spring fatigue; metal contact surfaces for greater durability and closer calibration; all-aluminum construction which avoids danger of cracking under temperature changes or breaking when carelessly handled.

Example: Replacing old-style "conventional" units with IRC All-Metal Rheostats, an equipment manufacturer used a smaller rheostat for the same application. Temperature rise was not increased and the net result was an important saving in such essentials as cost, space and weight.

TINY, INEXPENSIVE WIRE WOUNDS FOR LOW RANGE USES

From radio interference elimination in electrical appliances to thermal regulation and dozens of automotive, telephonic, electrical equipment and radio uses, IRC Type BW Insulated Wire Wound Resistors offer a practical answer to the need for dependable, low-range resistors in the smallest practical sizes and employed either singly or in matched pairs. Frequently they have replaced wire wound shunts previously wound by equipment manufacturers themselves — at a saving in cost and a great increase in quality. Although BW's have been on the market for several years and have been supplied to a list of manufacturers reading almost like a Who's Who in American industry, new uses for these handy little units are cropping up almost daily. It should pay you to investigate. Ask for IRC Resistor Bulletin III.

Example: A manufacturer of electrical office machinery had a radio interference elimination problem. Previously, he had paid more than \$3 for a condenser filter which was inserted in the line. Using BW Resistors, IRC succeeded in doing the job for about 22¢.

TAILOR-MADE INSULATED WIRE WOUNDS FOR MANY, MONEY- SAVING USES

Probably no other resistors are so adaptable to such a wide variety of uses as IRC type MW Insulated Wire Wounds. Their unique design results in an appreciable saving in space and initial cost as well as in mounting and assembling costs. Their flexibility in providing almost any needed taps allows still further savings. Complete insulation and moisture protection obtained by the use of molded phenolic make MW's comparable in dependability with the very highest grades of cement-coated and vitreous resistors. IRC Resistor Bulletin III sent on request.

Example: The adaptation of a standard MW Resistor to an electrical manufacturer's specific requirement by the addition of taps, replaced three resistors formerly used, saved 7¢ on cost and 2½" of space.

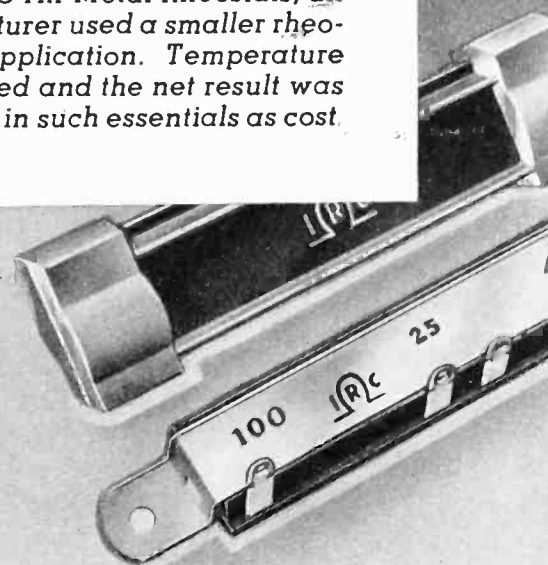

INTERNATIONAL RESISTANCE COMPANY

403 NORTH BROAD STREET, PHILADELPHIA, PA.

**"We Use
PRECISION BOBBINS
because they prevent shorts
from coil to core, afford EASIER
ASSEMBLY and are LOWER
IN COST!"**

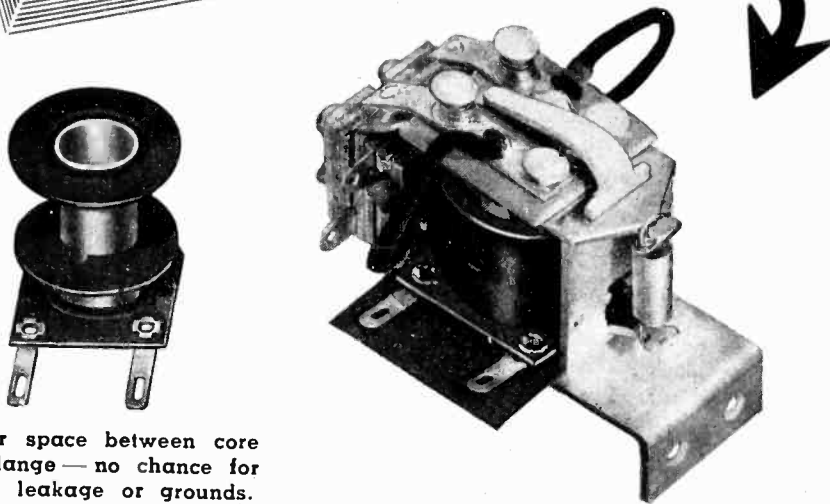

No air space between core and flange—no chance for shorts, leakage or grounds.

In the manufacture of relays, the Guardian Electric Mfg. Co. found that Precision Bobbins enabled them to make a superior product at a lower cost.

Winding their coils on Precision Bobbins speeded production, gave them a better finished coil and practically eliminated rejects.

If you have a coil problem that entails a space factor, insulation, assembly, or even one of lower costs, you, too, can use Precision Bobbins.

ROUND, SQUARE, RECTANGULAR



Precision Bobbins are made in three styles, round, square, and rectangular.

ANY SIZE

They can be had in practically any size and are so designed that they have greater winding space, thereby increasing efficiency.

FIBRE FLANGES

The core is spirally wound of dielectric paper with vulcanized fibre flanges offering greater strength and better insulation.

LOW COST

Because of their design and construction they are surprisingly low in cost.

Why not learn how much you can save by using Precision Bobbins? Samples can be furnished to your specifications if you'll send for our Bobbin Data sheet and then give us dimensions, etc.

Here's Your Chance To Save. Write today.

PRECISION PAPER TUBE CO.
2041 W. CHARLESTON ST. CHICAGO, ILL.

transformer is a half shell type rated at 650 volts center tapped at 70 ma, 5 volts at 2 amps, and 6.3 volts center tapped at 2 amps. It will be noticed that a tone control is provided in the phonograph stage only. This is because it is best to record with a decreased low frequency response. The volume level meter is a 0-1 ma instrument with a copper oxide rectifier. If a speaker or cutter with impedances other than those stated is used the set of drawings and values for most of the common speaker and cutter impedances in Fig. 2 will be useful. If it is desired to use the amplifier for a radio or phonograph, it is only necessary to eliminate the 6SJ7 or microphone stage and couple the radio tuner or phonograph to the 6C8G input. This amplifier has proved to be a versatile unit, and has many uses other than those specified.

Compound Decade Resistance Circuit

THE EDITORS ARE INDEBTED to Mr. Willard Moody for the accompanying circuit and table showing the connections of a simple decade resistance circuit, whereby resistances from 1,000 to 10,000 ohms may be obtained readily by closing four switches in the combinations shown. By combining a series of four such circuits, a decade box over a range of 1,000 to 1 may be readily obtained. The inconvenience of remembering the switch combinations may be minimized by fixing a copy of the table on the top of the box. The fact that only four precision resistors are required for each decade considerably reduces the cost of the device.

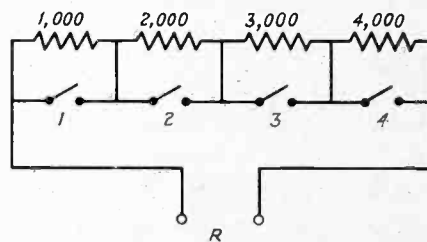

SWITCHES		R
Open	Closed	Ohms
1	2,3,4	1,000
2	1,3,4	2,000
3	1,2,4	3,000
4	1,2,3	4,000
1,4	2,3	5,000
1,2,3	4	6,000
3,4	1,2	7,000
1,3,4	2	8,000
2,3,4	1	9,000
1,2,3,4	—	10,000

Connections and switching combinations for simple decade box

Unique Use of Low-Loss Bakelite Polystyrene in RCA Victor Personal Radio

INDICATES SOLUTION TO MANY INSULATION PROBLEMS

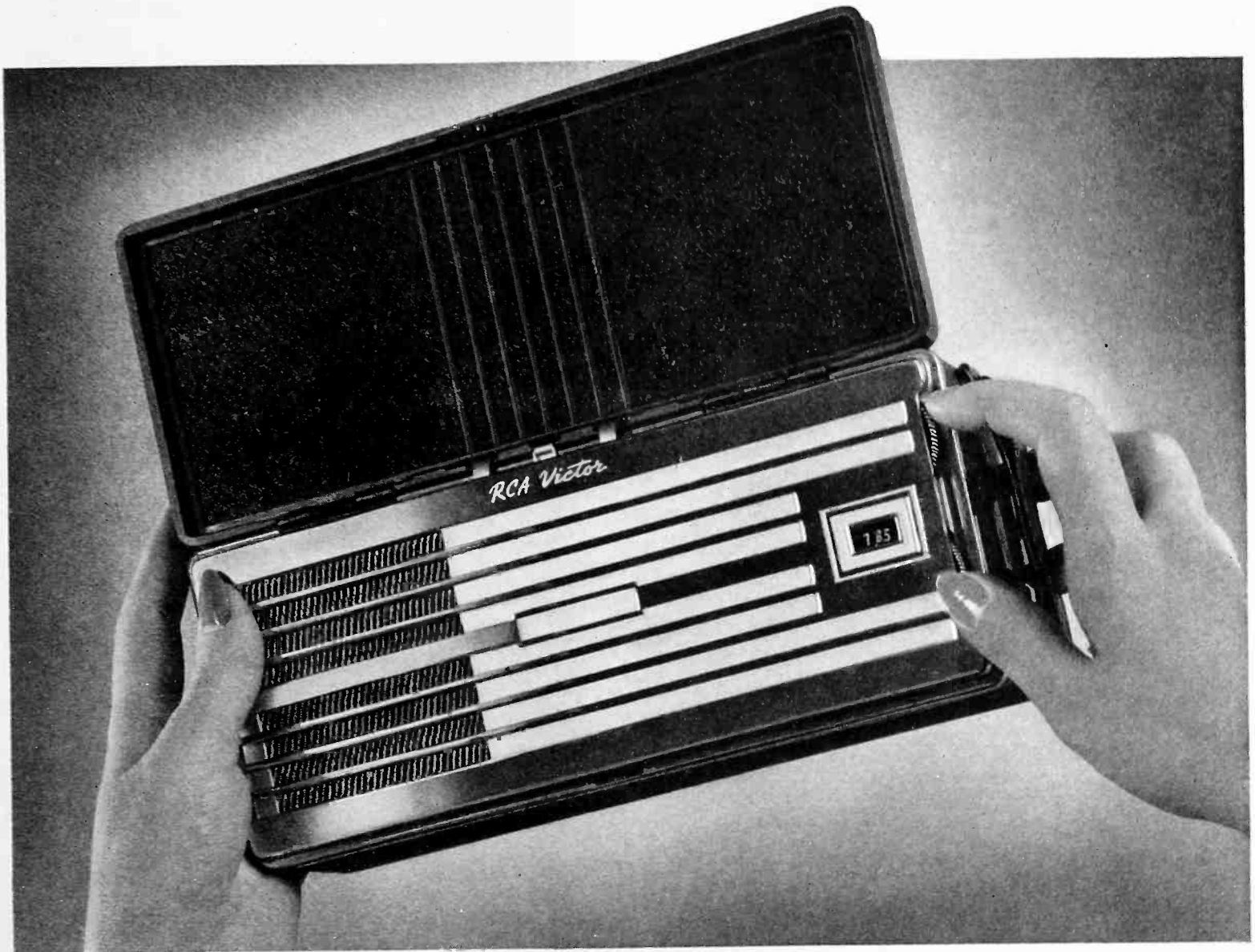

BECAUSE of its superior low-loss characteristics and resistance to moisture, and the ease with which it is molded into the smallest and most

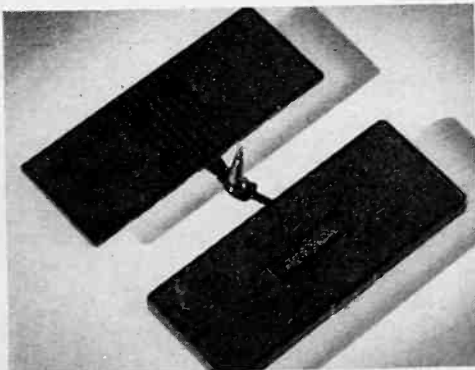

Two-piece lid of Bakelite Polystyrene as it comes from the mold—completely formed in one operation.

intricate parts, Bakelite Polystyrene offers countless opportunities for improved design and efficiency in electronic apparatus.

In the new RCA Victor Personal Radio, for instance, the two-piece antenna-containing lid is molded from Bakelite Polystyrene in rich jet-black. This material is also employed in clear crystal for the oscillating coil form and tube sockets. In each case Bakelite Polystyrene provides exceptional insulation for the unusually compact assembly, together with outstanding moisture resistance and dimensional stability. It is one of the main reasons

for the remarkable clarity and sensitivity of this midget receiver.

See how low-loss Bakelite Polystyrene can be advantageously adapted to *your* requirements by enlisting the cooperation of Bakelite Research and Development Laboratories.

BAKELITE CORPORATION
Unit of Union Carbide and Carbon Corporation



30 EAST 42ND STREET, NEW YORK

BAKELITE

The word "Bakelite" and the  Symbol are registered trade-marks of Bakelite Corporation

PLASTICS HEADQUARTERS

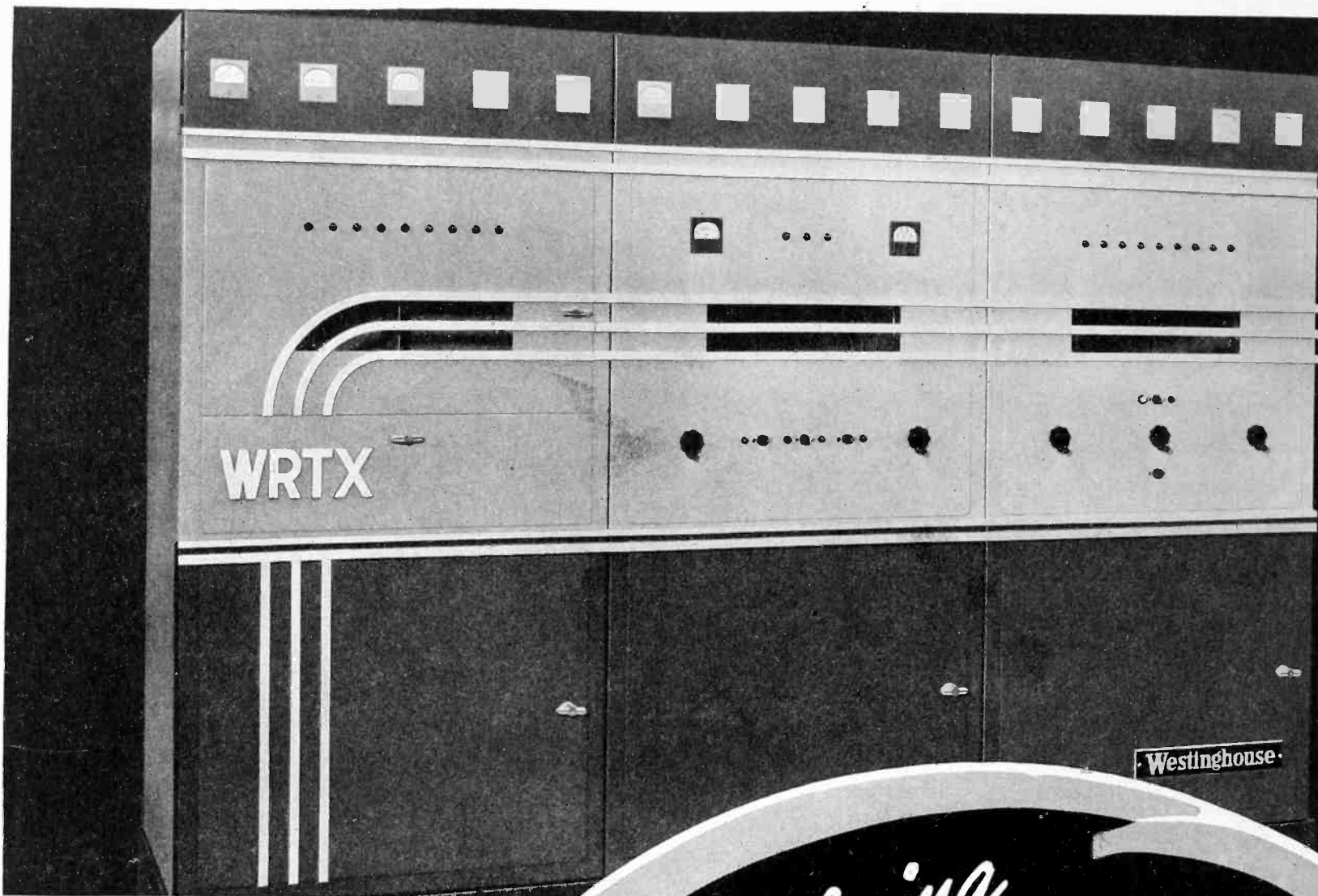

**ALL THESE ADVANTAGES
IN ONE COMPACT SET:**

- Air-cooled tubes in all stages.
- Low operating cost.
- Metal rectifiers for all low voltage plate supply.
- Inductive neutralization of the power amplifier.
- Equalized feedback.
- Compressed gas condensers.
- Complete elimination of fuses.
- Ease of adjustment.
- Full automatic control.
- Conservative operation of all tubes.
- Full complement of current and voltage indicators.
- Split-second change of power in 5/1 kw transmitter.

Introducing
the new 5HV (also 10HV for 10KW stations)
5KW BROADCAST TRANSMITTER
 by **Westinghouse**



Westinghouse

Here's

NEW ECONOMY NEW CONVENIENCE

in a transmitter for 5 kw and 10 kw stations

Westinghouse now offers to operators of 5000-watt and 10,000-watt stations an ultramodern broadcast transmitter. This new equipment, known as the Type HV transmitter, incorporates most of the distinctive advantages that are proving so successful at 50,000-watt KDKA and WBZ.

Economy of operation. With a highly efficient circuit, including Class "B" modulation, with long-life, air-cooled tubes throughout, with metal rectifiers for all low voltage plate supply, Type HV transmitters strike a new high in efficiency, a new low in maintenance costs.

Convenience of operation. Simple, straightforward circuits, non-critical tuning, and cubicle unit construction, with all parts easily accessible, make these HV transmitters easy to put on the air and easy to keep on the air with accurate, undistorted transmission.

Type HV Broadcast Transmitters are available in two ratings. HV-5 is a 5000/1000 watt transmitter with split-second change of power. HV-10 is a 10,000-watt transmitter. Ultramodern in appearance and design, they are the newest broadcast equipment of a company that has been intimately associated with the building *and operating* of radio equipment throughout the entire history of broadcasting.

**NOW! AS CLOSE AS
YOUR TELEPHONE...
COMPLETE INFORMATION
ON WESTINGHOUSE RADIO
TRANSMITTING TUBES**

For your convenience in obtaining full information and order service on Westinghouse Radio Transmitting Tubes quickly and with a minimum of effort, Westinghouse now provides Tube Sales Representation in all principal cities. Just get in touch with your regular Westinghouse Electric & Manufacturing Company sales office.

J-08024

Broadcast Equipment

Flying blind.

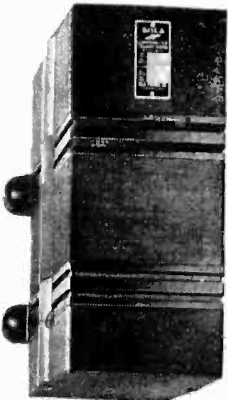
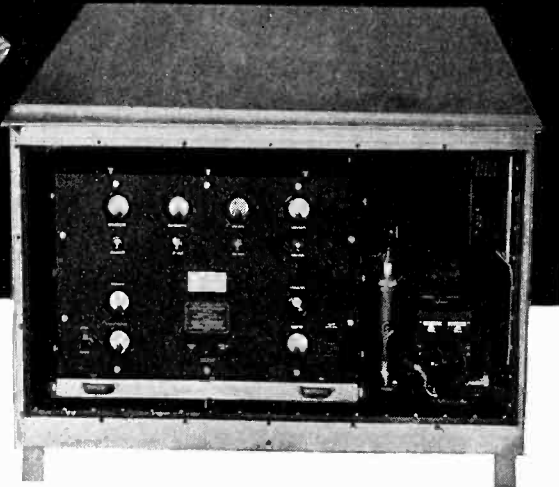

For capacities from 300 to 600 VA. Housing type with terminals enclosed in outlet box.

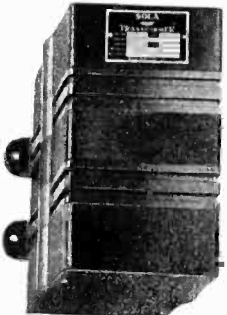

For capacities above 200 to 300 VA. Housing type with terminals enclosed in outlet box.



From 20-200 VA. Primary cord set, and output receptacle.



A new unit for applications up to 15 VA. Equipped with leads or terminals.

At the INDIANAPOLIS MUNICIPAL AIRPORT sixteen remotely controlled UHF radio transmitters comprise the C.A.A.—I.T.D. blind landing system—SOLA CONSTANT VOLTAGE TRANSFORMERS provide the power that insures dependable signals from these transmitters at all times by guarding against failures due to line surge or voltage drop.

For Communications—signal systems, photo electric devices, vacuum tubes and x-ray filaments, sound systems—in short the operation of any electrical device that functions from an AC line can be improved by the use of SOLA CONSTANT VOLTAGE TRANSFORMERS.

Fully automatic, instantaneous in operation, SOLA CONSTANT VOLTAGE TRANSFORMERS have no moving parts and require no maintenance. They are self-protecting and cannot be damaged by short circuit. AND—they will maintain their output voltage to within a *fraction of a percent* of the specified value, even though the line voltage varies as much as *thirty percent*.

Standard designs, to augment or replace non-regulating transformers, are available in capacities from 1 VA to 10 KVA—or special units can be built exactly to your specifications.

ASK FOR BULLETIN DCV—22

SOLA

CONSTANT VOLTAGE TRANSFORMERS

SOLA ELECTRIC CO. 2525 Clybourn Chicago, Illinois

Phase Inverter Circuits

C. G. McProud and R. T. Wildermuth

Sound Department, Paramount Pictures, Inc.

IN THE SEARCH FOR SIMPLIFIED and more economical circuits for radio receiver and amplifier construction, it was only natural that some means should be developed to eliminate the push-pull input transformer which is bulky, susceptible to hum pickup, and often a source of frequency discrimination. Without doubt, good transformers are available which are capable of supplying the desired results, but good transformers are far more costly than a few resistors and another tube. The development of the beam power with its high power sensitivity, and the general use of inverse feedback to eliminate the effects of cabinet resonance, speaker resonance,

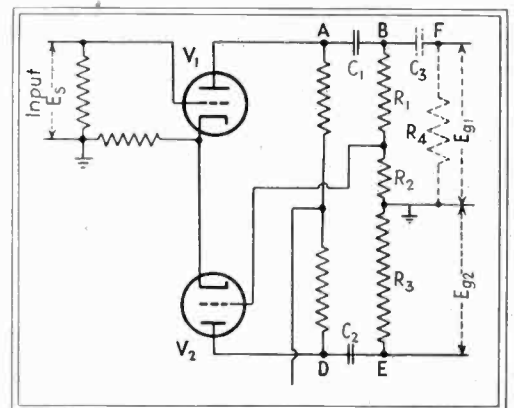

Fig. 1—Conventional two-tube phase inverter circuit

and deficiencies otherwise occurring in a production model, have advanced the use of phase inversion which eliminates the phase shift introduced by the input transformer. This effect is particularly vicious in the "driver" type of transformer.

Theoretically, a perfect phase inverter should be capable of taking a signal applied to its input and converting it to two signals of exactly equal magnitude which are exactly 180° out of phase, and which are exact facsimiles of the input signal. Actually, such perfect phase inversion is seldom obtained, nor is it absolutely necessary, for other considerations render it difficult to detect by ear slight differences in either phase or amplitude of a push-pull signal. This article has been written to point out the advantages and disadvantages of the more common types, and to present a new circuit, which, while not original with the writers, was investigated by them.

The most obvious circuit for phase inversion, and one in common use is that of Fig. 1. The signal is applied to the grid of V_1 , is amplified, and appears at point B , which is to be connected to the grid of one of the output tubes. A portion of that signal is fed back to the grid of the second tube, V_2 , that portion being tapped off at the



"We Have Taken Tubing for Granted"

The visitor who made this comment is the Superintendent of a Watch manufacturing concern.

So it is! Many "take for granted" that day after day customers are satisfied and need no attention. Others "take for granted" that, since there are no complaints, the concerns that keep them going are contented. Some more "take for granted" that the product as made year after year is as good as the best.

And again, the management—most endangered, "takes for granted" that so long as all is serene—everything is "hunky-dory" and the "goose hangs high".

The visitor who came to Superior did so out of curiosity. Another supplier's product was not uniform; ours was very *satisfactory*, but could we maintain it? Literally, because "he came, he saw", and was convinced that *The Superior Plant* is not just a flash, but sound from top to bottom.

If you, Mr. Reader, doubt what we say, pay us a visit, too.

A. Gabel

SUPERIOR TUBE CO.

[THE BIG NAME IN SMALL TUBING]

NORRISTOWN, PENNSYLVANIA

DESIGNERS are becoming increasingly aware that the solution to many of their small tube problems can be found at SUPERIOR TUBE . . . our doors are always open . . .

Tubing from 5/8" OD down . . . SUPERIOR  Seamless in various analyses. WELDRAWN  Welded and drawn Stainless. BRAWN  Welded and drawn "Monel" and "Inconel". SEAMLESS and Patented LOCKSEAM Cathode Sleeves.

'FOR FINE SMALL TUBING'



ATTENTION!

S. S. WHITE is ready to meet all demands for FLEXIBLE SHAFTS . . .

A FEW S. S. WHITE FLEXIBLE SHAFT APPLICATIONS

POWER DRIVES

Instruments
Counters
Indicators
Speedometers
Tachometers
Taximeters
General
Air Conditioners
Aircraft Fuel Pumps
Bottling Equipment
Business Machines
Concrete Surfacing
Concrete Vibrators
Cotton Pickers
Engraving Machines
Flame Cutting Machines
Food Handling Machines
Hair Clippers
Home Workshops
Kitchen Appliances
Massage Machines
Mechanical Toys
Portable Tools
Screw and Nut Setters
Shoe Machinery
Tube Cleaners
Valve Grinders
Washing Machines
Windshield Wipers

REMOTE CONTROLS

Automotive
Antenna Control
Carburetor Choke and Needle Valve Adjustment
Clock Setting
Crank Case Drain
Engine Governor Control
Gear Shift Control
Radio Receivers
Retractable Head Lights
Trip Mileage Reset
Aircraft
Antenna Reel Control
Beacon Receivers
Compass Loop Control
Gyro Pilot Control
Heating Register Control
Radio Receivers
Tab Control
Variable Pitch Propeller
General
Cam Position Indicator
Centralized Machine Controls and Adjustments
Electrical Switches
Gun Fire Controls
Oven Thermostat Controls
on Domestic Ranges
Valve Position Indicator
Washstand Drain Control
Weighing Balance Accuracy Adjustment

Manufacturers of instruments, radio and electronic equipment and other products which incorporate flexible shafts, will find S. S. WHITE a 100% dependable source of supply for all the shafts they need.

S. S. WHITE has the experience, the facilities and the organization to meet all demands—and to meet them on schedule and without sacrifice of the outstanding quality for which S. S. WHITE Flexible Shafts are noted.

At the left is a partial list of applications on which the performance and dependability of S. S. WHITE shafts have been time-tested and proved. Whenever you need a simple, efficient, reliable means for transmitting power or for remote control, you'll find the answer in an S. S. WHITE Flexible Shaft.

GET FULL DETAILS—SEND FOR THESE BULLETINS TODAY . . .

BULLETIN 1238
Flexible Shafts for POWER DRIVES

BULLETIN 38
Flexible Shafts for REMOTE CONTROL

BULLETIN 839
Flexible Shafts for AIRCRAFT

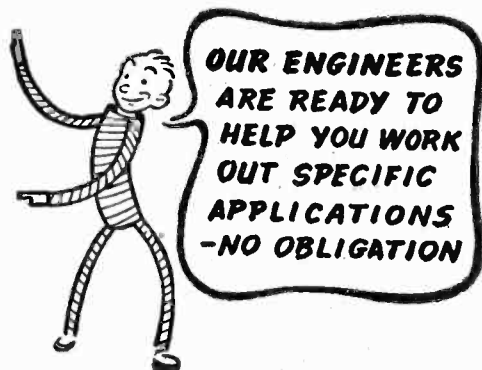

S. S. WHITE

The S. S. White Dental Mfg. Co.

INDUSTRIAL DIVISION

Department E, 10 East 40th St., New York, N. Y.

FLEXIBLE SHAFTS for POWER DRIVES, REMOTE CONTROL and COUPLING

junction of R_1 and R_2 . R_2 can be determined from the formula

$$\frac{R_2}{R_1 + R_2} = A_2$$

where A_2 is the voltage gain of the stage V_2 . R_3 is presumed to be equal to $R_1 + R_2$. The voltages available for the grids of the following tubes, E_{g1} and E_{g2} , are equal, opposite in phase, and can be represented by $E_s \times A_1$, where A_1 is the voltage gain of V_1 . With respect to the phase differential, there can be no doubt that there is 180° shift between points B and D , but there is a slight shift between D and E , which is caused by C_2 and R_3 . This could be corrected by the addition of another phase shifting element, C_3 and R_4 . Granted that this phase shift is slight, in some cases where large amounts of inverse feedback are used, it contributes to the limiting of the maximum that can be used. The main disadvantage of the

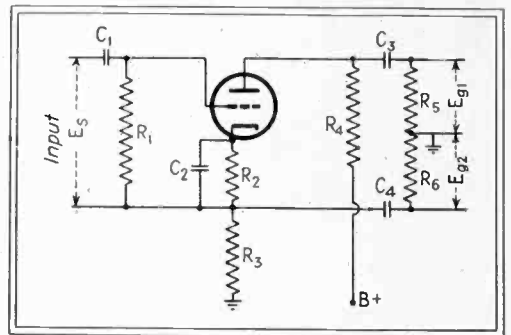

Fig. 2—One-tube phase inverter with input above ground potential

circuit lies in the fact that if V_2 should age, or should lose enough emission to seriously affect its amplification, the two output voltages are no longer equal, with attendant distortion. The main advantage lies in the gain obtained from the circuit in addition to the inversion. Variations of this circuit are common enough, in which V_2 is of a different type, or both V_1 and V_2 are in the same envelope, but the same factors apply to all of them.

A circuit which performs the inversion with only one tube is shown in Fig. 2. The main disadvantage here is the necessity for introducing the signal between points which are considerably above ground potential. Differences in capacity between ground and these points will affect the similarity between the signals appearing at the grids. The output voltages here will be seen to be

$$E_{g1} = E_{g2} = \frac{1}{2} A E_s$$

R_3 and R_4 are equal. The bias for the tube is developed across R_2 , with the customary by-pass condenser, C_2 .

This circuit can be improved by introducing the signal between grid and ground, which will remove one of the objections to it. Then the degeneration which occurs across resistor R_3 will reduce the gain of the stage to approximately zero. From the standpoint of cost, this circuit is a satisfactory solution, since, exclud-

Give a "Pick-up" to your winter season!



With the coming of FM, it's more important than ever for you to use the highest quality mikes on the market. The 639A and 639B assure your readiness to lead in developing microphone technique for this new high quality Transmission Medium.

...with these two great all-purpose mikes!

Western Electric's two Cardioid Mikes—639A and 639B—are the answer to your microphone Engineer's prayers. They'll handle any pick-up situation.

The 639A gives you three pick-up patterns: Non-directional, bi-directional and cardioid—covers most studio situations. The 639B gives you all these, plus three special cardioid patterns each with two "dead zones" (at 110°, 130°, and 150° respectively) to help you keep out unwanted sound, reduce still further effects of reverberation, and operate auditorium speakers at higher level without "sing".

THE PROOF IS IN THEIR USE

Get your order into Graybar *now*—boost your winter season from the start with these famous mikes designed for *Better Pick-Up!*

ASK YOUR ENGINEER!

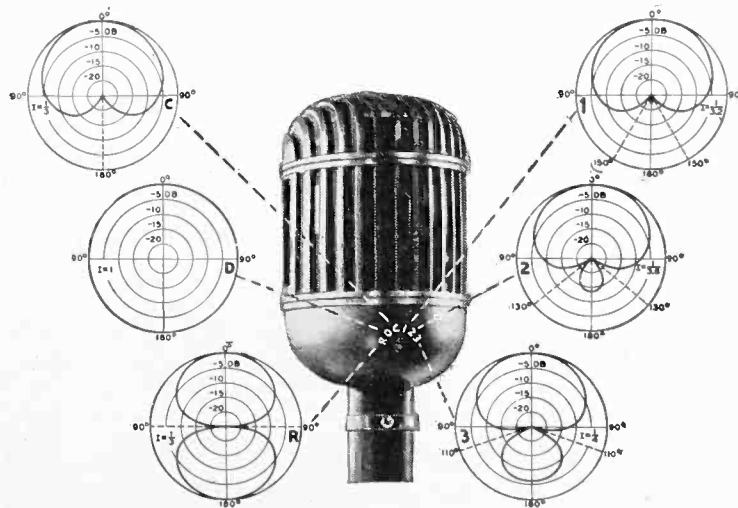

639B Mike showing the six different pick-up responses . . . at the turn of a switch. The 639A offer C, D and R shown above.

Western Electric



DISTRIBUTORS: In U. S. A.: Graybar Electric Co., New York, N. Y. In Canada and Newfoundland: Northern Electric Co., Ltd. In other countries: International Standard Electric Corp.

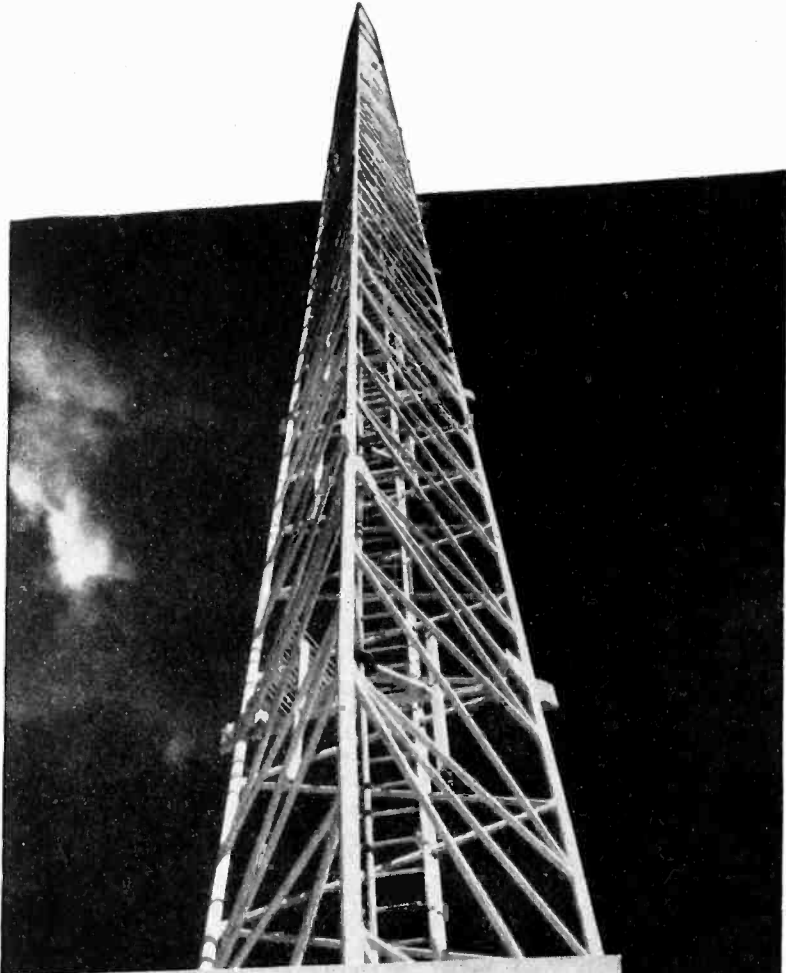

Signal Strength

Various factors govern the signal strength and coverage of a broadcasting station. Among these are design, height and insulation of the radiator. Because of the experience and researches of Blaw-Knox engineers in dealing with these problems, covering the entire history of radio, Blaw-Knox Vertical Radiators will enhance the efficiency of any station. We will be glad to make our experience and facilities available to you.

BLAW-KNOX VERTICAL RADIATORS

BLAW-KNOX DIVISION of Blaw-Knox Company
Farmers Bank Bldg., Pittsburgh, Pa.
Offices in principal cities

DISTRIBUTOR
Graybar
ELECTRIC COMPANY

ing the input condenser C_1 and the output condensers C_3 and C_4 which are common to all of these circuits, only one tube, four resistors, and one high-capacity, low-voltage electrolytic condenser are used.

As long ago as 1937, there appeared in print another circuit, Fig. 3, which is essentially the same as the one just discussed. In this case, the bias was obtained from a point on the voltage divider. Assuming that the voltage

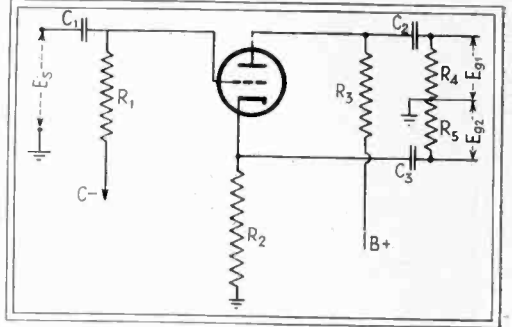

Fig. 3—One-tube circuit with bias obtained from separate supply

divider would be used anyway, the components are reduced to one tube and three resistors, though it is highly probable that some filtering would be required in the grid circuit. In the article cited, the tube used was a 76, with R_2 and R_3 25,000 ohms each. It was claimed that the output voltages were approximately $0.8 E_s$, resulting in a loss of 2 db. By increasing the values of R_2 and R_3 to 50,000 ohms, the output becomes equal to the input.

In Fig. 4, the phase inverter of Fig. 2 has gone through another stage of simplification, and now requires the tube and four resistors. R_3 and R_4 are 50,000 ohms each. R_1 , representing the input impedance of the stage, is set at 0.5 megohm. R_2 is selected to produce the proper grid bias. With the other values mentioned, R_2 comes

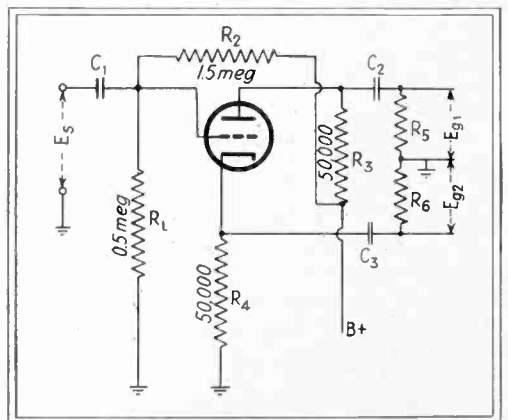
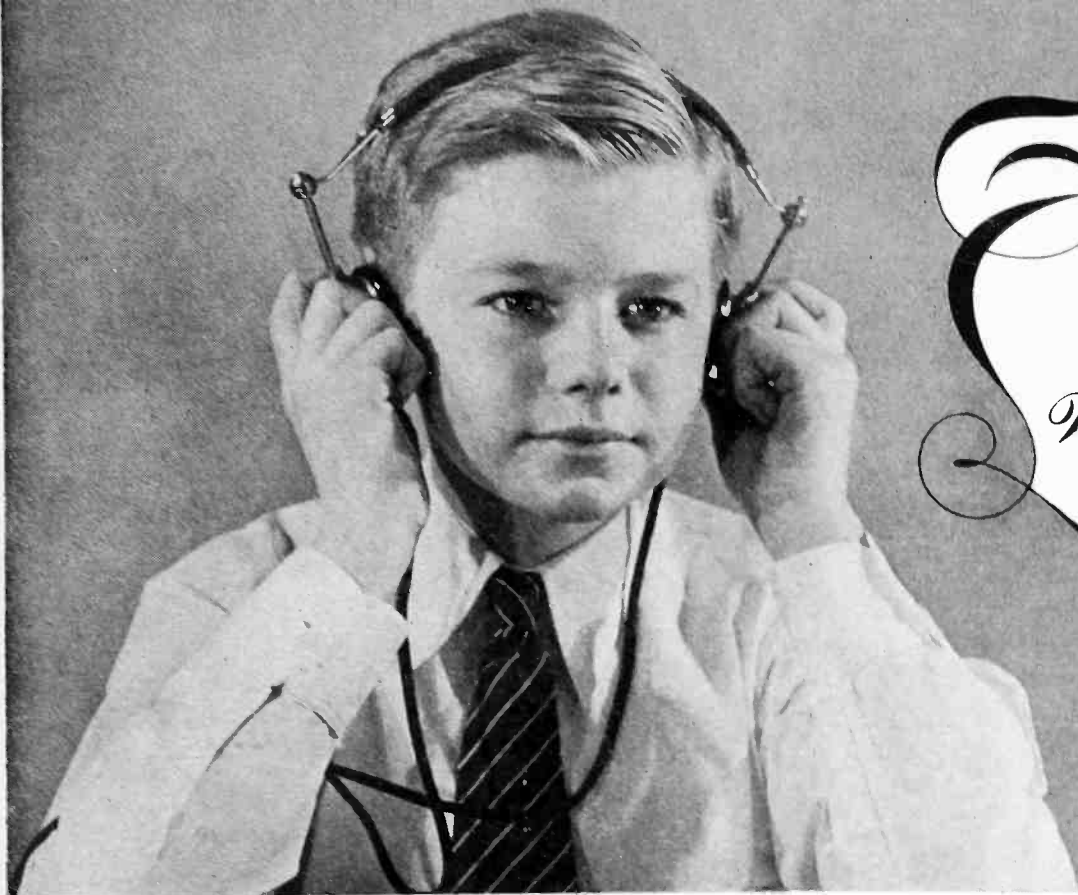
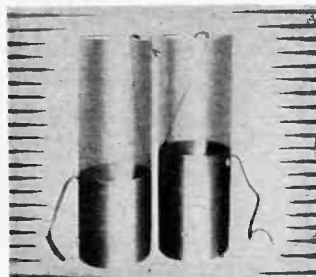

Fig. 4—Method of obtaining bias from plate supply

out to be 1.5 megohms. This value is not at all critical, and the usual resistance tolerances will be close enough to make an excellent phase inverter. Nor is the circuit critical about what kind of tube is used, a low- μ or a high- μ triode, or a pentode, the output is still the same,



RADIO,
We knew you when...



LEYDEN JAR

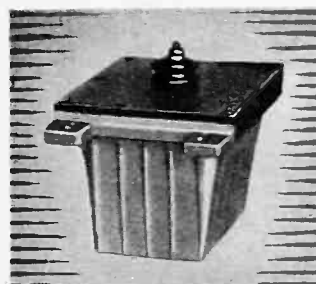

ORIGINAL
 DUBILIER
 TRANSMITTING
 CAPACITOR



Those first crude efforts to communicate sound—we all do remember. We had just developed the first transmitting capacitor, replacing the old cumbersome Leyden jar. And you, Radio, made it your own.

How quickly you grew, and how big. Each swiftly changing scene in your meteoric career brought new demands . . . demands undreamed a decade before. Yet, through it all, Cornell-Dubilier kept pace. In laboratories whose lights burned far into the night, our staff of researchers worked hand in hand with seasoned engineers exploring, developing, perfecting new capacitor types to meet your expanding broadcast requirements.

Yes, Radio, we kept the pace. Indeed, we have been ahead of you at times, anticipating your capacitor needs even before they had arisen. But it is not for this we pride ourselves. Rather, it is your unswerving loyalty to us over the trying years.

Early that confidence you displayed in the ability of Cornell-Dubilier to deliver became as a challenge to us. So have we cherished it. So did we, time and again because of it, redouble our efforts, check back, make certain that the C-D capacitor of the day possessed all of the dependability it was possible for the hand and brain of man to achieve.

So, Radio, we stand with you today, shoulder to shoulder, as a bright new dawn comes over the horizon—Television! And the courage of the pioneer that has served us for three dramatic decades, made of us the world's largest manufacturer of capacitors exclusively, will not fail us now. For Radio, we knew you when.

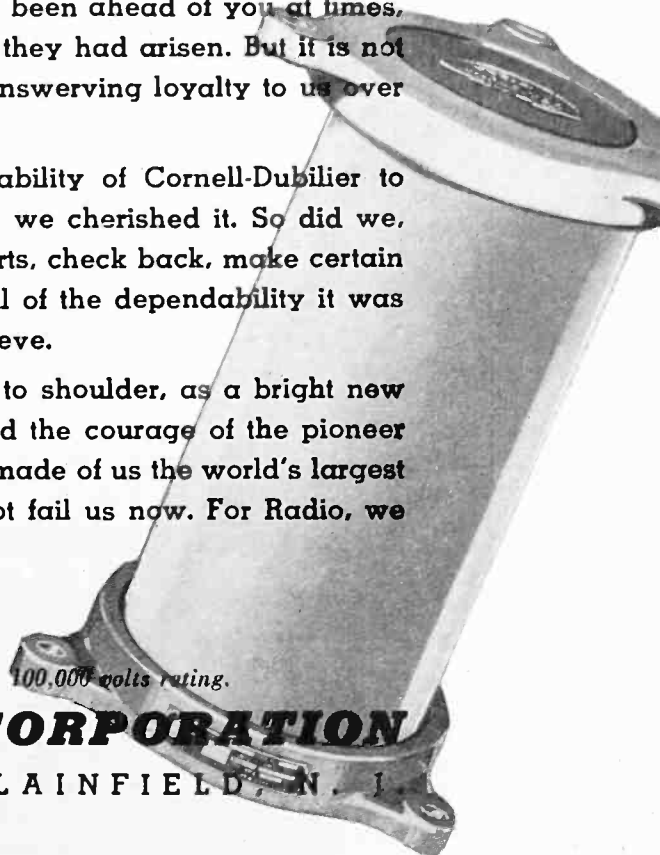

Complete listing of Mica and Dykanol capacitors in all capacities—up to 100,000 volts rating.

CORNELL - DUBILIER ELECTRIC CORPORATION
 1006 HAMILTON BOULEVARD • SOUTH PLAINFIELD, N. J.

DECORATED!



for maximum electrical efficiency

Throughout the electrical industry one solder is recognized as first in the field:

KESTER ROSIN-CORE SOLDER

This famous product is the result of Kester's 43 years of continuous solder manufacture. The rosin-flux is scientifically prepared in Kester laboratories specifically for electrical work. This flux eliminates corrosion and gives added protection against fire hazard. For perfect wiring results, specify Kester Rosin-Core Solder on every job.

Write Kester engineers for expert advice on any soldering operation. There is no obligation.

KESTER SOLDER COMPANY

4204 Wrightwood Avenue

Chicago, Illinois

Eastern Plant: Newark, N. J.
Canadian Plant: Brantford, Ont.

KESTER CORED SOLDERS

STANDARD FOR INDUSTRY

equal to the input. The triode is naturally simpler, so a 6J5 or a 6SJ7, triode connected, is preferred. There is no amplification, since in adding up the voltage gain of several stages to obtain the overall of an amplifier, none should be considered as coming from the inverter. There is a slight differential in the phase shift occurring at the two output grids, which was thought to be due to the capacity between cathode and a normally grounded heater. Actually, the shift is around 2° at 8000 cps, which is slight enough to overlook. It can be corrected by decreasing the grid leak on the plate side, but that introduces other difficulties which are more ob-

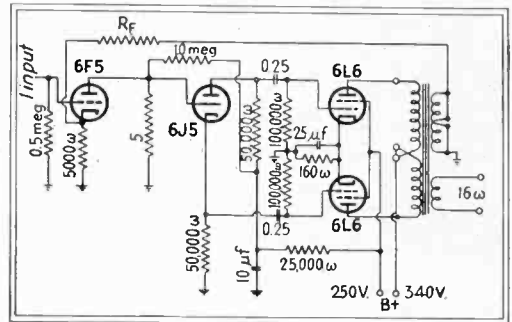

Fig. 5—Complete amplifier with direct-coupled input stage

jectionable. For exact equality in amplitude of the output voltages, R_2 and R_1 should be balanced as closely as possible.

At a plate supply potential of 200 volts applied at B+, the plate current is approximately 1.0 ma. Therefore the cathode is 50 volts above ground. The R_2 , R_1 network applies 50 volts to the grid. The plate current increases sufficiently to place a bias of about 4.5 volts to the grid, automatically balancing itself to that operating condition, no delicate adjustments being necessary. Measurements show that with a 250-volt supply, a r-m-s voltage of 45 volts can be obtained with 2 per cent distortion, which is more than enough to drive a pair of 45's in the 275-volt operating condition, in which they require 39 volts r-m-s. This requires an input voltage equal to that which can be supplied easily by a 6R7 with 250-volt supply and a load resistor of 0.25 megohm. The output voltages obtainable with a 6J5 in this circuit, with 2 per cent distortion are shown in the curve in Fig. 6.

With 50 volts available on the grid of the inverter tube, the next step is to couple the preceding tube directly to it, using that voltage for its plate supply. Normally, the other tube would be coupled to this grid through a condenser, using a separate load resistor with the attendant decoupling filter resistor and condenser. This has been found unnecessary, for the plate of a 6F5 or 6SF5 can be connected directly to the 6J5 grid with considerable improvement in overall operation, particularly if inverse feedback is to be used. The bias resistor

UNQUESTIONED

Dependability

the need of today!

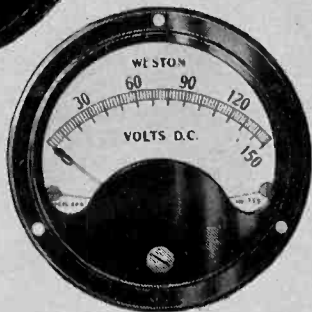
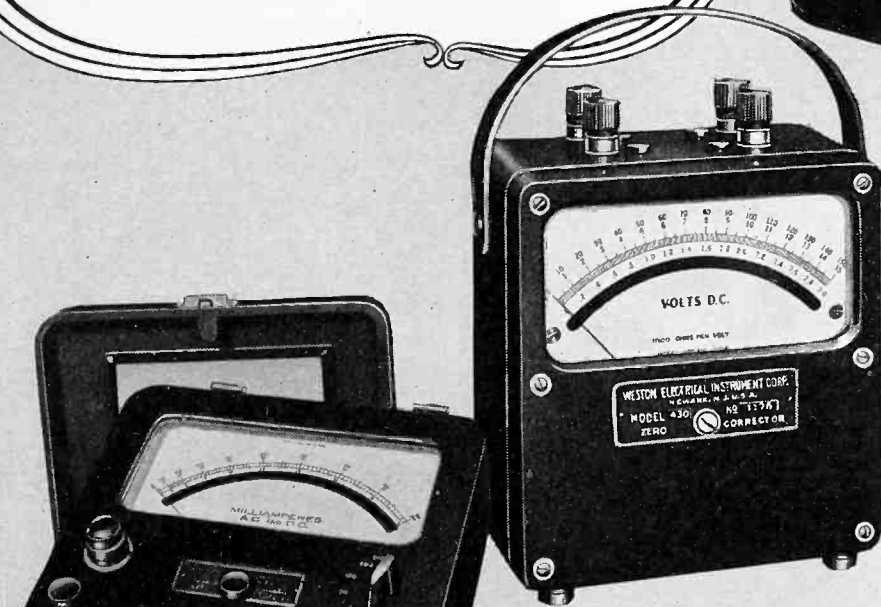
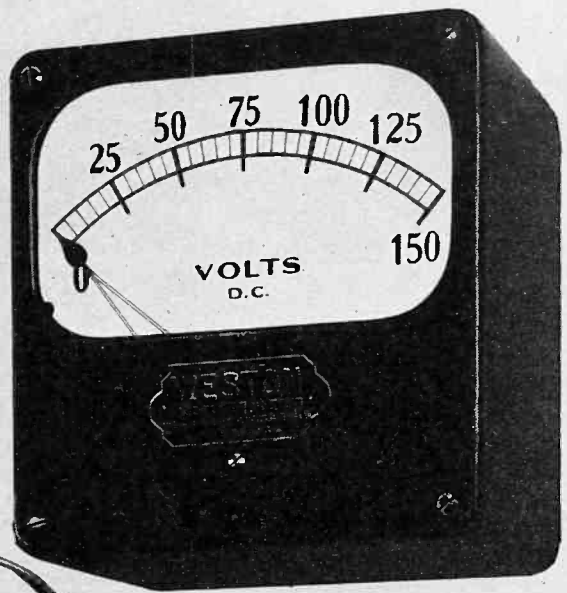

Today with *production for defense* straining the facilities of an ever widening group of plants, the need for unquestioned dependability in instrumentation grows more acute. From the generators, through the laboratories to final assembly and inspection lines, *truthful indications* are essential to prevent work interruptions and waste . . . assure peak efficiency at every step. *It's a period which challenges the dependability of instruments . . .* and, as in all like periods, the demand for WESTONS daily grows apace. For WESTONS fully meet this challenge with their proved combination of *unquestioned accuracy* and *long-time dependability*. It's the same combination which make WESTONS "first choice" in normal times . . . and it becomes an ever more valid reason for WESTON preference today. Weston Electrical Instrument Corporation, 618 Frelinghuysen Avenue, Newark, New Jersey.

Laboratory Standards . . . Precision DC and AC Portables . . . Instrument Transformers . . . Sensitive Relays . . . DC, AC, and Thermo Switchboard and Panel Instruments.

WESTON

Specialized Test Equipment . . . Light Measurement and Control Devices . . . Exposure Meters . . . Aircraft Instruments . . . Electric Tachometers . . . Dial Thermometers.

FOR OVER 52 YEARS LEADERS IN ELECTRICAL MEASURING INSTRUMENTS

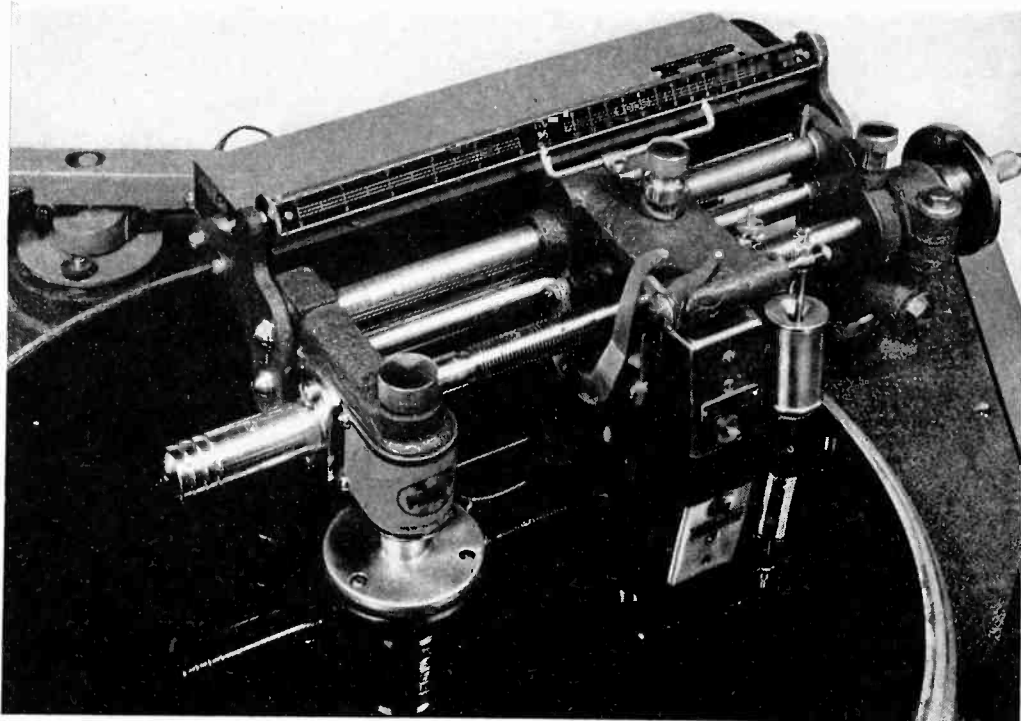

MODERNIZE YOUR RECORDING INSTALLATION WITH THIS NEW PRESTO TURNTABLE

Here is a new turntable designed to replace the famous Presto 6-C and 6-D recording turntables which have been standard equipment in United States and Canadian broadcasting stations for the last four years.

Mounting and operating dimensions are identical with the previous equipment but the performance has been greatly improved.

NEW FEATURES OF PRESTO 6-N TABLE:

1. **Less Vibration.** Records made on the 6-N table reproduce on the highest fidelity playback equipment without a trace of flutter or rumble.
2. **Wider Frequency Response — Higher Sound Level.** Presto 1-C cutting head records useful range of 50-8000 C.P.S.—gives 6 to 8 D B higher play-

back level than previous heads.

3. **New cutting head mounting spaces grooves more accurately,** facilitates quick change of feed screws.
4. **New overhead cutting mechanism redesigned to simplify alignment with the turntable,** can be removed for transportation by loosening one screw.
5. **Standard table includes spiraling feed screw, vertical damper, cam lever for lowering cutting needle, 4 pitch time scale, automatic equalizer and Presto 1-C high fidelity cutting head.**

LIBERAL TRADE-IN ALLOWANCE TO
STATION OWNERS WHO WISH TO
REPLACE EITHER 6-C or 6-D TABLES
WITH THE NEW PRESTO 6-N TABLE.
Write giving type and serial number
for cost of exchange.

PRESTO RECORDING CORPORATION
242 West 55th Street, New York, N. Y.

World's Largest Manufacturers of Instantaneous Sound Recording Equipment

of 5000 ohms, not bypassed, is a logical point for the introduction of the feedback voltage. Figure 5 shows the complete circuit of an amplifier using this system. The bias-balancing resistor has been reduced to 1.0 megohm to make up for the plate current of the 6F5. Without feedback, an input signal of 0.44 volts r-m-s is all that is required to drive the 6L6's to overload. With 17 db of feedback, the input requirements increase to 3.1 volts r-m-s for maximum output. In the circuit shown, using two 500-ohm output transformer secondaries in shunt, the feedback resistor, R , will give 10 db of feedback when its value is 240,000 ohms. 100,000 ohms will give 17 db of feedback, 68,000 ohms 20 db, 52,000 ohms 22 db, and 36,000 ohms 24 db. The amplifier is perfectly stable with 22 db of feedback. When it was first constructed, the conventional method of coupling the 6F5 and the 6J5 was used, and with that connection, the amplifier became unstable with 17 db of feedback, due to phase turnover. With the slight change to direct coupling, the additional 5 db became available, using the same parts throughout otherwise. It will be noted that the output transformer has its two 125 ohm secondaries strapped in parallel, a connection advanced by J. N. A. Hawkins to increase the available feedback due to the reduction in leakage reactance in the transformer, and consequent decrease in phase turnover.

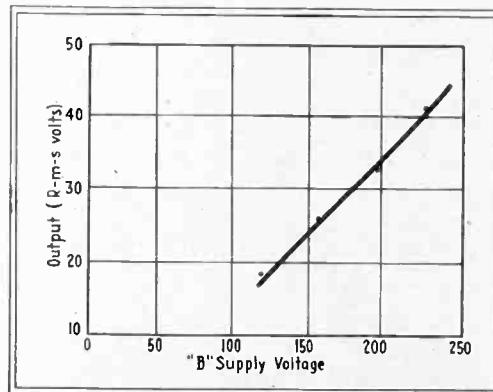



Fig. 6—Output voltage from 6J5 as function of plate supply voltage

The complete amplifier shown has a gain of 60 db, figured as most public address amplifiers are, from a 100,000 ohm source. Measured with a gain-set terminated with 500 ohms, with the 500,000 ohm input bridged directly across it, it has a gain of 30 db; with the feedback resistor of 100,000 ohms removed, the gain increases to 47 db. With a suitable input transformer, and using the feedback of 17 db, it makes a very useful power amplifier to follow a pre-amplifier, mixer and booster or similar equipment with a nominal output level of 0 db. It is flat to within 0.2 db from 30 to 13,000 cycles, and has a power output of 35.2 db at 2 per cent distortion, that is, roughly, 20 watts.



*Your General Purpose
Public Address Projector*

When the new Type "S" Peri-Dynamic Projector was introduced at the June Trade Show, immediate and wide acceptance throughout the public address industry was prophesied. All of these predictions have now materialized with even greater emphasis than was prophesied. High power handling capacity (15 to 25 watts), low cost and outstanding ability to reproduce both speech and music with a crisp clean cut quality fully justifies sustained leadership in this new product. Public address dealers and engineers who are not familiar through experience with this new product will do well to place their orders immediately. A steady increase in factory production permits prompt delivery.

Dealers' price, Type "S" Peri-Dynamic Projector (No. SPH-81) complete with Permanent Magnet Speaker installed, \$31.20 Net (mounting standard extra). Dimensions: 24-inch bell; 30 inches overall length.

by

Jensen
6001 SOUTH LARAMIE AVENUE • CHICAGO
CABLE ADDRESS: JERAD, CHICAGO

Specify DAVEN ATTENUATORS

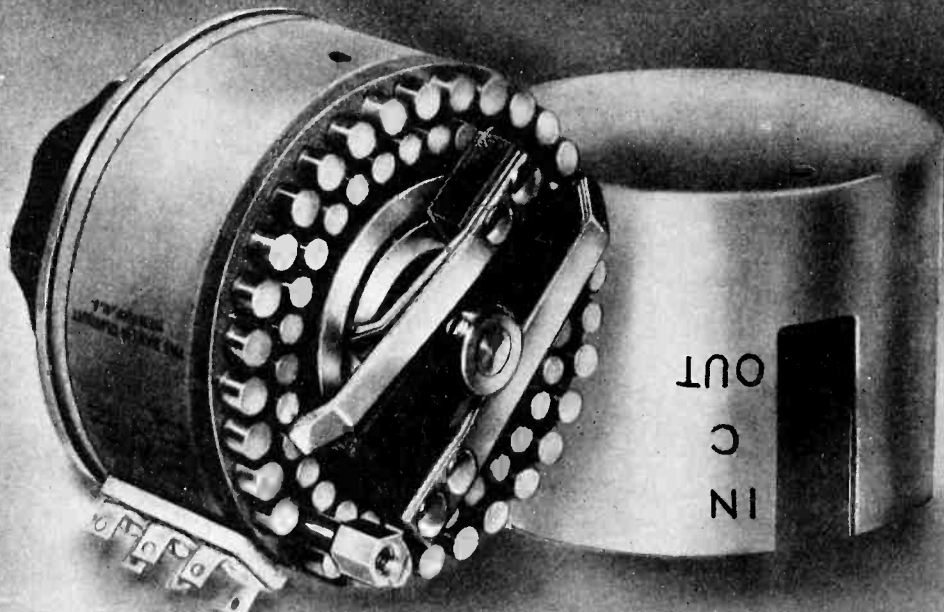

To INSURE PRECISE QUALITY
and RUGGED DEPENDABILITY
in your SPEECH INPUT EQUIPMENT

Substitutes, whose only merit can be a claim that they are "just-as-good", are **NEVER** the equal of the original. When ordering new speech input equipment, insist upon **DAVEN ATTENUATORS**, particularly when these precision components **COST YOU NO MORE**. **DAVEN** leadership in the field is clearly indicated not only by the caliber but also the number of organizations who are satisfied users.

Our catalog lists the most complete line of precision attenuators in the world. However, due to the specialized nature of high fidelity audio equipment, a large number of requirements are encountered where stock units may not be suitable. If you have such a problem, write to our engineering department.

THE DAVEN COMPANY
158 SUMMIT STREET • NEWARK, NEW JERSEY

Newspaper Employs Register Control Profitably

A SAVING ESTIMATED at \$15,000 a year resulting in a reduction of waste from 7 per cent to 3 per cent is claimed for the photoelectric system of register control used on the rotogravure color press of the *Philadelphia Inquirer*. In the printing of four-color rotogravure pictures, it is necessary that the positions of four-color impressions be maintained automatically within the narrow tolerances necessary to avoid fringes of color in the finished reproduction. The rotogravure press of the *Inquirer* operates at a web speed of approximately 1,000 feet per minute. Each color unit in the press is fitted with two photoelectric scanning heads. One head scans the margin of the web of paper as it moves through the press. On this paper are register or index marks equally spaced and printed simultaneously with the first color impression. The second phototube scanning head is arranged to scan a disk attached to the printing cylinder. When the marks on the paper and the disk on the printing cylinder are accurately in register, the two scanning heads produce synchronous impulses. However, if the paper gets ahead of or falls behind the disk on the printing cylinder, the two sets of impulses are not synchronized. A net control voltage is produced, and relayed through thyratrons to a pilot motor which advances or retards the position of the paper with respect to the printing cylinder until synchronism is again achieved. In printing the remaining two colors the same method is used, employing different register marks laid down by the successive color impressions.

CENTIMETER WAVE GENERATOR



Generator for operation in the 3000 to 4000 megacycle region at the R.C.A. plant at Camden and used by research engineers for studying centimeter wave detection measurements and performance



Bacillus S. paratyphi,
magnified 12,000 diameters



Lacquer pigments,
magnified 27,000 diameters

FROM RCA LABORATORIES COME

Radio Eyes

FOR MICROBE HUNTERS



Anthony van Leeuwenhoek of Amsterdam was the first to peer into the universe of the infinitesimal. With his crude microscope, he discovered in 1683 the "small beasties" which Pasteur and Koch and Theobald Smith later branded the most dangerous enemies of man—the germs of disease.

BUT there are micro-organisms too small for optical microscopes to detect. These instruments operate by visible light, which cannot resolve objects much smaller than the wavelength of the light. Bacteriologists have been able to see only the larger microbes. They have been able only to hope that somewhere, somehow, an instrument would be found that would magnify not 1,500, but 20,000... 50,000... 100,000 diameters!

Scientists in RCA Laboratories have engineered such a microscope. They studied the electrons active in radio and television, whose length was but a tiny fraction of that of a light wave. Research proved these electrons could be used as "seeing" rays. Focused by powerful magnets upon photographic film, they would reveal what had hitherto been invisible.

Research is Radio's Road to Progress

RCA's contribution to the development of the electron microscope is the result of a far-seeing policy laid down by the founders of the company in 1919: *that fundamental research must be the keystone of every activity of RCA.*

RCA research has made broadcasting better. It has made receiving sets better. It has perfected a magic voice for the motion picture. It has pioneered in television. It has developed facsimile transmission of pictures and printed matter. It has made substantial contributions to industrial progress in fields outside of radio... From continuing RCA research will come still more progress... still greater services to America and to the world.

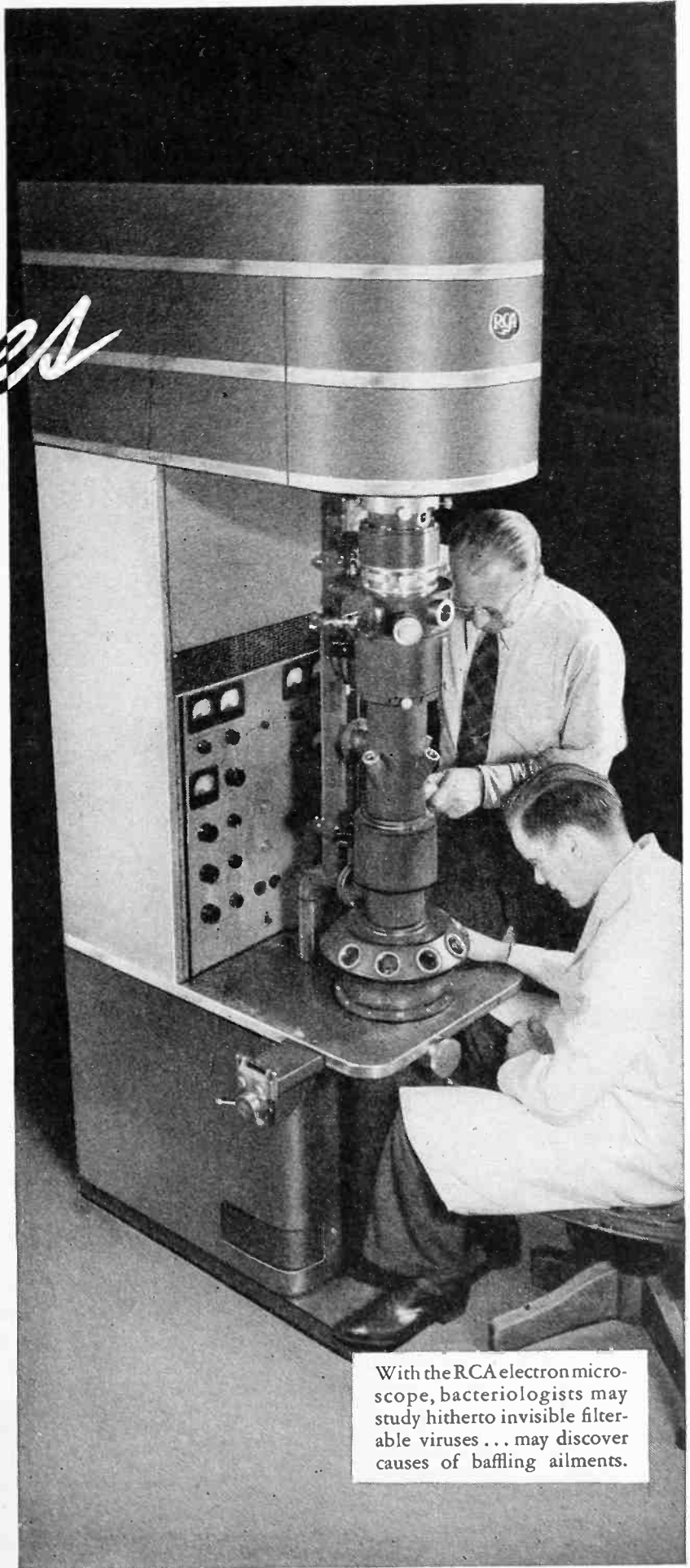

With the RCA electron microscope, bacteriologists may study hitherto invisible filterable viruses... may discover causes of baffling ailments.



RADIO CORPORATION OF AMERICA

RADIO CITY, NEW YORK

RCA Manufacturing Co., Inc.
RCA Laboratories

Radiomarine Corporation of America
R. C. A. Communications, Inc.

National Broadcasting Company
RCA Institutes, Inc.

When a Second is Ages



an achievement of **CALLITE WELDS and TUNGSTEN LEADS**

ENGINEERS HAVE WAYS to measure instantaneous response. It comes out "micro-something" but anyway, it means *fast*. No one knows how fast any better than Dumont Laboratories. Recently Dumont perfected a cathode-ray relay tube whose response is instantaneous. There is no time-lag whatever, since there are no mechanical parts. Virtually "inertia-less," this relay may be activated by a breath of air, a sound, or even a shadow.

A relay so sensitive places heavy demands on the tube's components. Like so many modern pioneers in the field of electronic development. Dumont confidently turned to Callite for welds and tungsten leads.

For Callite research and Callite's ability to meet "metallurgent" situations has been of a sort to inspire confidence. Over the years its able researchers have accumulated a vast fund of knowledge. This in turn has been applied to the development of a wide range of products—lead-in wires, filaments, welds, grids and plates. And of these it can be said, unqualifiedly: they have met the reliability-test of Time.

Such experience in creating formed parts of tungsten and molybdenum for special requirements has established Callite as a logical source of supply. If you have a special problem, it will pay you to consult Callite. Catalog on request.

CALLITE TUNGSTEN CORPORATION

544 - 39th STREET

CABLE:



UNION CITY, N.J.

"CALLITES"

Design and Application of X-ray Tubes

(Continued from page 30)

used when the demand increases. A few installations for medical therapy at voltages of 800,000 and 1,000,000 are now operating successfully in this country, but as yet these tubes must be permanently connected to a vacuum pump. Figure 8 shows a million volt tube of a multisection construction, which uniformly distributes the voltage gradient along the envelope.¹³

The application of x-rays to medical therapy is rapidly growing and a large number of hospitals and x-ray therapy specialists have equipment adequate for treatment. Continued use of x-rays for this work is, of course, expected, and very likely the field will be enlarged.

X-Ray Tubes for Industrial Radiography

Tubes for industrial radiography at voltages from 140,000 to 400,000 volts are essentially the same as those used for medical therapy, and identical tubes have been used in most cases. Because of the need for greater detail in industrial radiography, recent tubes for therapy have been redesigned to incorporate line focus, which has reduced the focal spot size to about one-third of that previously used. In the hooded anode tube for self-rectified operation considerable development has been necessary to focus a rectangular beam of electrons down the circular anode hood. This has now been accomplished for both 200,000 and 400,000 volt tubes.

The application of x-rays for industrial radiography is rapidly expanding. Today practically all welded vessels are being radiographed since the boiler code requires 100 per cent radiographic inspection of all welded tanks for use at high pressure, high temperature, or greater than 1½ inch in thickness. Figure 9 shows a mod-

• ANNOUNCING •

By Special Request of

and

For the Individual Use of

ELECTRONICS SUBSCRIBERS

ANNUAL REFERENCE SHEETS SERVICE

Because of the continual requests from subscribers for additional copies of the Reference Sheets appearing in each month's issue of Electronics and for the great number of subscribers who do not wish to cut their issue to remove the page for insertion in the binder, Electronics is willing to undertake the additional service so many subscribers have requested of supplying a complete set of these charts on an annual basis.

All Reference Sheets contained in Electronics during the calendar years 1939 and 1940 will be reprinted on heavy paper, assembled into two sets, by years, and punched for a binder. Either or both sets will be sent to those subscribers who have placed their order at the time of publication (December 1940). Extra sets will not be published.

Enough subscribers have indicated their

intention of ordering sets to enable us to keep the price down to \$1 per set plus a small delivery charge. To such subscribers that send payment with their order, thus eliminating bookkeeping and collection expense, we will pay the delivery costs.

This service is open only to bona fide subscribers at the time of publication, December 1, 1940.

Sets of charts will be printed for only the quantity of orders on hand December 1st. Delivery will be about December 15th. Placing your order with payment now will insure you a complete set of charts for the binder without further thought.

Electronics reserves the right to terminate this arrangement and refund payments if orders are not sufficient to permit publication at above prices.

Place order with and make checks payable to ELECTRONICS YEARLY SERVICE

ELECTRONICS

330 WEST 42ND ST.

NEW YORK CITY

ELECTRONICS — October 1940



THIS BULL DOG SWALLOWS SPARKS

The new Bull Dog Vacu-Break Safety Switch designed to reduce and confine arcing in the Vacu-Break head chambers when the circuit is ruptured, not only displays advanced engineering and design, but a wise choice of materials.

Four INSUROK sections, two molded and two laminated, complete the head assembly. INSUROK was used because of its adaptability to both molded and laminated requirements; for its known constant dielectric and physical characteristics; its chemical inertness; its ability to withstand continuous severe usage.

INSUROK is available in many grades and colors; in sheets, rods and tubes for fabrication in your own plant, or in completely finished molded or laminated parts or products ready for assembly. Whatever your plastics needs they are best met in INSUROK... the Richardson precision plastic. Consult Richardson technicians, without obligation, of course, about any problem involving the use of any plastic.

INSUROK THE PRECISION PLASTIC

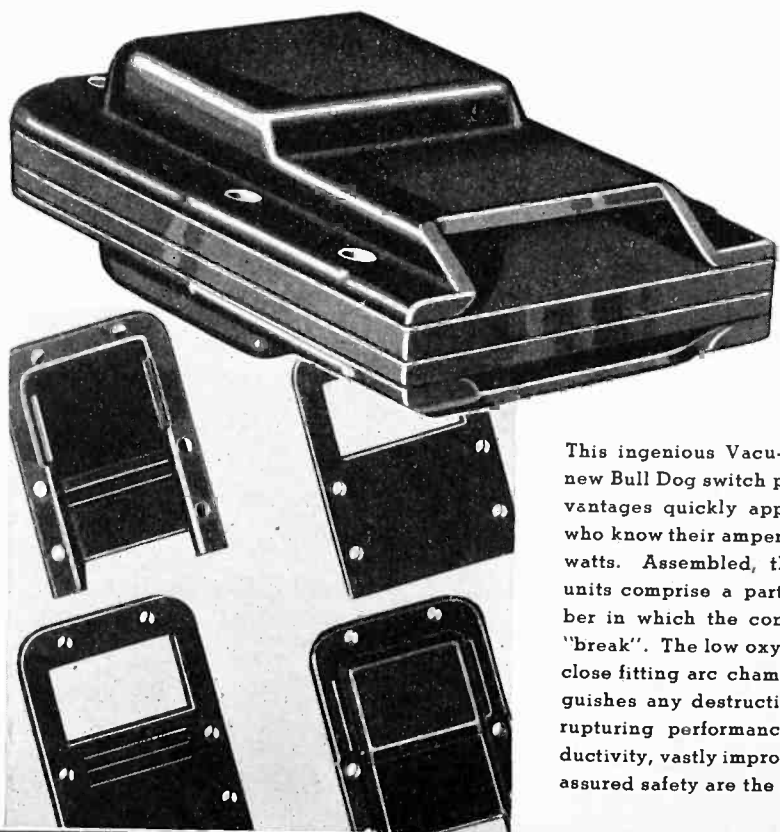

This ingenious Vacu-Break head of the new Bull Dog switch possesses many advantages quickly appreciated by those who know their amperes, ohms, volts and watts. Assembled, the four INSUROK units comprise a partitioned arc chamber in which the contacts "make" and "break". The low oxygen content of this close fitting arc chamber quickly extinguishes any destructive arcing. Better rupturing performance, increased conductivity, vastly improved operation and assured safety are the result.

The RICHARDSON COMPANY

MELROSE PARK, (CHICAGO) ILL. FOUNDED 1858 LOCKLAND, (CINCINNATI) OHIO
NEW BRUNSWICK, N. J. INDIANAPOLIS, IND.
DETROIT OFFICE: 4-252 G. M. BUILDING, PHONE MADISON 9386
NEW YORK OFFICE: 75 WEST STREET, PHONE WHITEHALL 4-4487

ern portable industrial radiographic unit for 220,000 volts which is capable of penetrating up to 3 inches of steel.

The future of this x-ray application looks very good and undoubtedly will be extended as more industrial companies realize its possibilities. Radiography of metals of greater thickness than the 4 to 5 inches now readily accomplished at 400,000 volts, can be obtained by the use of 1,000,000 volts. Perhaps in the future welds and steel sections up to 8 inches in thickness will have to be radiographed. If so, the equipment can be made available. Aside from these clearly defined uses of x-rays, there are some miscellaneous applications sufficiently interesting to warrant mentioning here. Irradiation of plants, seeds, bulbs, flowers, etc. has been carried on experimentally and very interesting changes in growth have been observed.¹⁴ At one time or another the use of x-rays has been proposed to irradiate meats, tobacco, milk, etc. to accomplish sterilization. This is theoretically possible, but the intensity of x-rays needed to destroy bacteria quickly is so great that it is unlikely that commercial application will be forthcoming soon.

References

- (1.) W. D. Coolidge, A Powerful Roentgen Ray Tube with Pure Electron Discharge. *Physical Review*, Vol. 11, 409-430, 1913.
- (2.) G. W. C. Kaye, "X-rays." Longmans, Green & Co., 1929.
- (3.) A. H. Compton & S. K. Allison, "X-rays in Theory and Experiment." D. Van Nostrand Co., 1935.
- (4.) Gustav Bucky, "Grenz Ray Therapy." The Macmillan Co., 1929.
- (5.) H. M. Terrill & C. T. Ulrey. "X-ray Technology." D. Van Nostrand Co., 1930.
- (6.) G. L. Clark, "Applied X-rays." McGraw-Hill Book Co., 1927.
- (7.) W. P. Davey, "Study of Crystal Structure and Its Applicability." McGraw-Hill Book Co., 1934.
- (8.) U. S. Patent No. 1,590,971.
- (9.) M. J. Gross & Z. J. Atlee, Progress in the Design and Manufacture of X-ray Tubes. *Radiology*, October, 1933.
- (10.) U. S. Patent No. 1,610,863.
- (11.) M. J. Gross & Z. J. Atlee, Progress in the Design of Rotating Anode Tubes. *American Journal of Roentgenology*, February, 1939.
- (12.) W. D. Coolidge & C. N. Moore, A Water-Cooled High Voltage X-ray Tube. *The American Journal of Roentgenology*, November, 1923. P. 884-889.
- (13.) E. E. Charlton, W. F. Westendorp, L. E. Dempster, and George Hotelling, A New Million Volt X-ray Outfit. *Journal of Applied Physics*, June, 1939.
- (14.) Benjamin M. Duggar, "Biological Effects of Radiation." 2 vol. McGraw-Hill Book Co., 1936.

TUBES

Tubes registered with the R.M.A. Data Bureau during the month of August, 1940 and during 1936

Tube Registry

Tube Types Registered by R.M.A. Data Bureau During August, 1940

Type 14H7 (GL)

Prototype 7H6 (GL)

R-F pentode, semi-remote cutoff; heater type; (T-9) integral glass envelope-base; seated height 2¼ inches (max.); 8-pin loktal base.

$E_A = 14.0$ v
 $I_A = 0.16$ amp
 $E_b = 250$ v
 $E_{c2} = 0$ v
 $E_{c1} = 150$ v
 $E_c = -2.5$ v
 $I_b = 9.5$ ma
 $I_{c2} = 3.5$ ma
 $g_m = 3800$ μ hos
 $r_p = 0.8$ megohm
 $C_{in} = 9.0$ μ f
 $C_{out} = 7.0$ μ f
 $C_{op} = 0.007$ μ f (approx)

Basing 8V-L-5

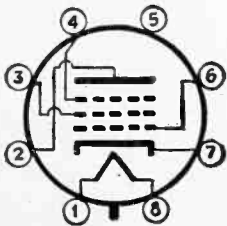

Type 3A8 (GT)

DIODE, triode, pentode; tapped filament type; (T-9) glass envelope; seated height 2¼ inches (max.); skirted miniature top cap; 8-pin intermediate shell octal base.

$E_f = 2.8$ v
 $I_f = 0.05$ amp
TRIODE SECTION
 $E_b = 90$ volts
 $E_c = 0$ v
 $I_b = 0.20$ ma
 $\mu = 65$
 $r_p = 0.20$ megohm
 $g_m = 325$ μ hos
 $C_{input} = 2.6$ μ f
 $C_{output} = 4.2$ μ f
 $C_{op} = 2.0$ μ f
PENTODE SECTION
 $E_b = E_{c2} = 90$ v
 $E_c = 0$ v
 $I_b = 1.5$ ma
 $I_{c2} = 0.5$ ma
 $g_m = 750$ μ hos
 $r_p = 0.8$ megohm
 $C_{in} = 3.0$ μ f
 $C_{out} = 10$ μ f
 $C_{op} = 0.012$ μ f (max)
 Basing 8AS-0-1

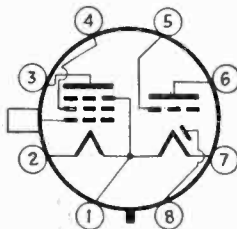

Type 7H7 (GL)

R-F PENTODE, semi-remote cutoff; heater type; (T-9) integral glass envelope-base; seated height 2¼ inches (max.); 8-pin loktal base.

$E_A = 7.0$ v
 $I_A = 0.32$ amp
 $E_b = 250$ v
 $E_{c2} = 150$ v
 $E_c = -2.5$ v
 $I_b = 9.5$ ma
 $I_{c2} = 3.5$ ma
 $g_m = 3800$ μ hos
 $r_p = 0.8$ megohm
 $E_c @ 1\%$ of $g_m = -19$ v
 $C_{in} = 8.0$ μ f
 $C_{out} = 7.0$ μ f
 $C_{op} = 0.007$ μ f (max)
 Basing 8V-L-5

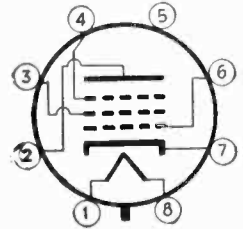

Type 1LD5 (GL)

DIODE-PENTODE; sharp cutoff; filament type; (T-9) integral glass envelope-base; seated height 2¼ inches (max.); 8-pin loktal base.

$E_f = 1.4$ v
 $I_f = 0.05$ amp
 $E_b = 90$ v
 $E_{c2} = 45$ v
 $E_c = 0$ v
 $I_b = 0.6$ ma
 $I_{c2} = 0.1$ ma
 $g_m = 575$ μ hos
 $r_p = 0.75$ megohm
 $C_{in} = 3.2$ μ f
 $C_{out} = 6.0$ μ f
 $C_{op} = 0.18$ μ f (max)
 Basing 6AX-L-0

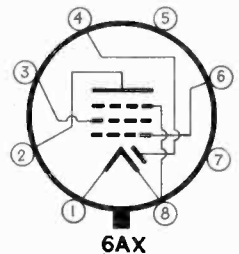

Type 9CP4

PICTURE tube; magnetic focusing; magnetic deflection; diameter 9⅞ inches (max.); seated length 15⅝ inches (max.); phosphor, white, 6-pin base.

$E_A = 2.5$ v
 $I_A = 2.1$ amps
 $E_b = 7000$ v
 $E_c =$ always negative
 Screen input power = 10 milliwatts/sq cm (max)
 Control grid voltage for cut-off = 110 v
 Peak-to-peak control grid voltage = 25 v
 Grid to cathode capacitance = 12 μ f
 Basing 4AF-0-0

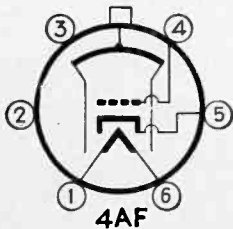

Type 12CP4

PICTURE tube; magnetic focusing; magnetic deflection; diameter 12⅞ inches (max.); seated length 18⅝ inches (max.); phosphor, white; 6-pin base.

$E_A = 2.5$ v
 $I_A = 2.1$ amps
 $E_b = 7000$ v
 $E_c =$ always negative
 Screen input power = 10 milliwatts/sq cm
 Control grid voltage for cut-off = 110 v
 Peak-to-peak control grid voltage = 25 v
 Grid to cathode capacitance = 12 μ f
 Basing 4AF-0-0

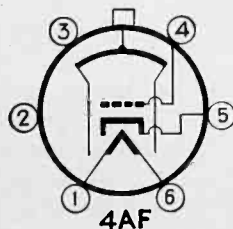

U-H-F FOR FIREFIGHTING



Firemen Arthur Meyerson and Samuel Harmatuk with Fire Commissioner John J. McElligott and Mayor LaGuardia at the LaGuardia Airport. The firemen are demonstrating to the Mayor new portable u-h-f radio transmitting and receiving equipment which they have devised

THE RELAY

THAT SURPRISED EVEN ITS DESIGNERS
**OFFERS 4 DEFINITE
 BENEFITS TO USERS**

1. Reduced user's assembly cost (relays are pre-adjusted)
2. More reliable operation (contacts have heavy pressures—are self-cleaning)
3. More positive action (armature restored by leaf spring)
4. No overheating (coil is self protecting).

You can enjoy these benefits. Write Dept. B for information.

AN OFFER . . .

Tell us (1) Your product or operation (2) Function and performance details (3) Whether chief objective is improved performance or reduced cost. We'll send a helpful recommendation, free. Write Dept. B

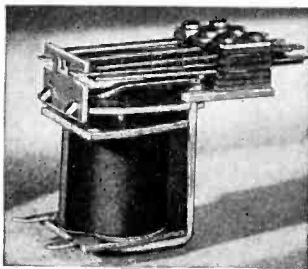

AUTOMATIC ELECTRIC

Relay Makers Since 1898

1033 West Van Buren Street, Chicago

Tube Types Registered By R.M.A.
 Data Bureau in 1935 and 1936

Type 6L7

PENTAGRID mixer converter, heater type, metal envelope, seated height $2\frac{3}{8}$ inches, 7-pin octal base.

$E_h = 6.3$ v
 $I_h = 0.3$ amp
 $E_b = 250$ v
 $E_{c2,4} = 100$ v
 $E_{c1} = -3$ v
 $E_{c3} = -10$ v
 $I_b = 2.4$ ma
 $I_{c2,4} = 7.1$ ma
 $r_p = \text{Greater than } 1 \text{ megohm}$
 $g_c = 375 \mu\text{mhos}$
 Basing 7T

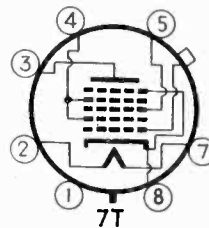

Type 43

POWER amplifier pentode, heater type, ST-14 glass envelope, seated height $4\frac{1}{8}$ inches, 6-pin base.

$E_h = 25.0$ v
 $I_h = 0.3$ amp
 $E_b = 135$ v
 $E_{c2} = 135$ v
 $E_{c1} = -20$ v
 $I_b(\text{zero signal}) = 37$ ma
 $I_{c2}(\text{zero signal}) = 8$ ma
 $R_L = 4000$ ohms
 $P_o = 2$ watts (9%)
 Basing 6B

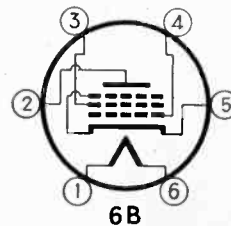

Type 84/6Z4

FULL-WAVE high vacuum rectifier, heater type, ST-12 glass envelope, seated height, $3\frac{1}{8}$ inches, 5-pin base.

$E_h = 6.3$ v
 $I_h = 0.5$ amp
 CONDENSER INPUT TO FILTER
 $E_{ac}(\text{per plate, rms}) = 325$ v (max)
 $I_{dc} = 60$ ma (max)
 CHOKE INPUT TO FILTER
 $E_{ac}(\text{per plate, rms}) = 450$ v (max)
 $I_{dc} = 60$ ma (max)
 $E_{drop}(I_{dc} = 60 \text{ ma}) = 20$ v
 Basing 5D

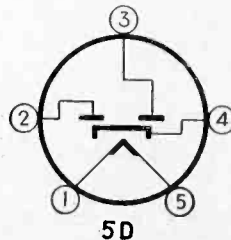

Type 6E5

ELECTRON ray tube (indicator type with triode unit), heater type, ST-12 glass envelope, seated height $3\frac{1}{8}$ inches, 6-pin base.

$E_h = 6.3$ v
 $I_h = 0.3$ amp
 $E_b = 250$ through 1 megohm
 $E_{target} = 250$ v
 $I_b = 0.24$ ma
 $I_{target} = 4$ ma (approx)
 $E_c(\text{shadow angle} = 90^\circ) = 0$ v
 Basing 6R

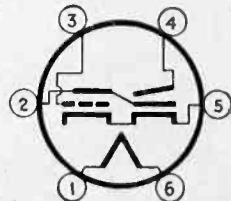

A
C
C
U
R
A
T
E

Biley



Biley Quartz Crystals and Mountings are precision-made for all frequencies between 20Kc. and 30Mc. Catalogue G-11 describes the complete line. Write for your copy.

**QUARTZ
 CRYSTALS**

FOR GENERAL COMMUNICATION FREQUENCIES

BLILEY ELECTRIC COMPANY

UNION STATION BUILDING

ERIE, PA.

D
E
P
E
N
D
A
B
L
E

Type 0Z3

FULL-WAVE gas-filled rectifier (ionic heated cathode), no heater, ST-12 glass envelope, seated height, $3\frac{1}{8}$ inches, 5-pin base.

$E_{dc}(\text{output}) = 300 \text{ v (max)}$
 $I_{dc}(\text{output}) = 30 \text{ ma (min)}$
 75 ma (max)
 $I_p(\text{peak}) = 200 \text{ ma (max)}$
 Starting voltage = 300 v (min)
 $E_{drop}(\text{dynamic}) = 24 \text{ v}$
 Basing 5N

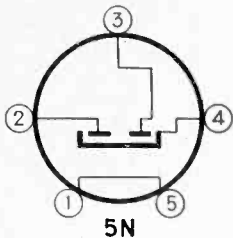

Type 0Z4

FULL-WAVE gas-filled rectifier, no heater, metal envelope, seated height $2\frac{1}{8}$ inches, 4-pin octal base.

$E_{dc}(\text{output}) = 300 \text{ v (max)}$
 $I_{dc}(\text{output}) = 30 \text{ ma (min)}$
 75 ma (max)
 $I_p = 200 \text{ ma (max)}$
 Starting voltage = 300 v (min)
 $E_{drop}(\text{dynamic}) = 24 \text{ v (avg)}$
 Basing 4R

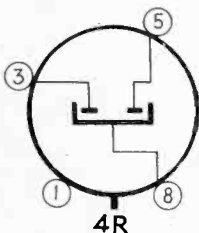

• • •

WEATHER EXPERTS WAGE AERIAL WARFARE

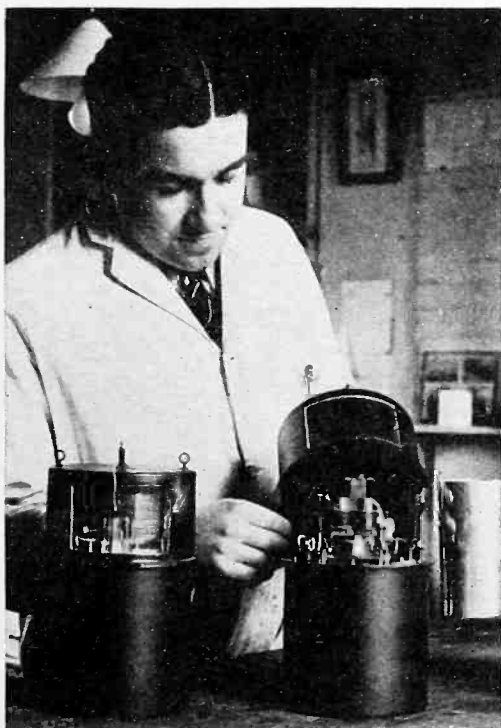

The meteorological officials of England's Air Ministry are making use of radio-sonde instruments for investigating the upper atmosphere and recording weather conditions through several miles of the earth's atmosphere. A radio transmitter sent aloft by a balloon emits signals which are interpreted in terms of temperature, humidity and other meteorological factors. Here an operator is placing a cover over one of the small radio-sonde transmitters



Pleasing the family

A Major Job for G-E Plastics Is Serving Its Own Company

ONE of the largest users of laminated plastics is our own General Electric Company. In all its apparatus and appliance plants this durable, light-weight, resilient, moisture-resistant material helps solve some particular insulation problem.

To solve these problems, Plastics Department engineers collaborate with engineers and designers throughout the General Electric Company and upon them rests the responsibility of determining and developing special grades of Textolite laminated insulation for the various electronic applications.

Their experience in "pleasing the family" gives Plastics Department engineers a singular opportunity to acquire a detailed knowledge of all factors involved in almost every kind of an electronic insulation problem. This experience may well be applied to your own particular problem and well may you obtain the same satisfactory results as General Electric itself.

For additional information on General Electric's services in the laminated field, write Section C-30, Plastics Department, General Electric Company, One Plastics Avenue, Pittsfield, Mass.

GENERAL  ELECTRIC

PD-303

COILS

Electrical



Windings



A COMPETENT and experienced organization devoted to the design and manufacture of coil windings.

Paper interlayer sections—form wound and bobbin wound coils.

Equipped for prompt production on quantity or small orders.

REPRESENTATIVES

W. A. JORDAN
295 Madison Ave., New York, N. Y.

GILBERT GISLASON
82 St. Paul St., Rochester, N. Y.

PARAGON SALES CO.
(C. H. Fryburg)
402 Cherry St., Philadelphia, Pa.
A. J. LOEB SALES CO.
1836 Euclid Ave., Cleveland, Ohio

MAGNETIC WINDINGS COMPANY

Sixteenth and Butler Streets

EASTON, PENNA.

A practical Noise Instrument for Routine Production Testing in your plant

Industrial Noise Analyzer RA-273

- Simplified controls
- Rugged mechanical construction
- 38 filter combinations
- Large indicating meter
- Feedback stabilized amplifier
- A. S. A. standard sound meter
- Used with moving coil microphone or vibration unit

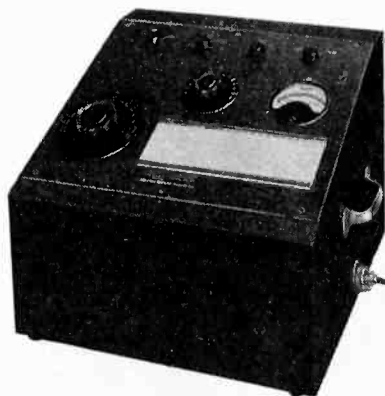

FOR THE PLANT—Large number of filter combinations permits segregation of different noises characteristic of specific defects in assembly. Simple controls adaptable to production line conditions. Rugged design insures calibration stability and reliability.

FOR THE ENGINEER—A convenient instrument for wide band frequency analysis, to assist in location and correction of noise sources. Sound level measurement in accordance with A. S. A. standards. For more complete information write to the address below.

Electrical Research Products Inc.

SUBSIDIARY OF

Western Electric Company

195 BROADWAY, NEW YORK, N. Y.

Type 1B4

R-F screen grid amplifier, filament type, ST-12 glass envelope, seated height $3\frac{3}{8}$ inches, 4-pin base.

$E_f = 2.0$ v
 $I_f = 0.06$ amp
 $E_b = 180$ v (max)
 $E_{c2} = 67.5$ v (max)
 $E_c = -3$ v
 $I_b = 1.7$ ma
 $I_{c2} = 0.6$ ma
 $r_p = 1.5$ megohm
 $\theta_m = 650$ μ hos
Basing 4M

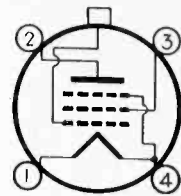

4M

Type 6B6 (G)

Prototype 75

DUPLEX-DIODE high- μ triode, heater type, ST-12 glass envelope, seated height, $3\frac{3}{8}$ inches, 8-pin octal base.

$E_A = 6.3$ v
 $I_A = 0.3$ amp
 $E_b = 250$ v
 $E_c = -2$ v
 $I_b = 0.9$ ma
 $\mu = 100$
 $\theta_m = 1100$ μ hos
Basing 7V

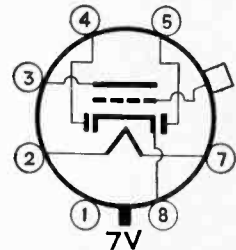

7V

Type 1D7 (G)

Prototype 1A6

PENTAGRID converter, filament type, ST-12 glass envelope, seated height $3\frac{3}{8}$ inches, 8-pin octal base.

$E_f = 2.0$ v
 $I_f = 0.06$ amp
 $E_b = 180$ v (max)
 $E_{c3,5} = 67.5$ v
 $E_{c2} = 180$ v through 20,000 ohms
 $E_{c1} = -3.0$ v
 $I_b = 1.5$ ma
 $I_{c3,5} = 2.0$ ma
 $I_{c2} = 2.5$ ma
 $\theta_c = 300$ μ hos
Basing 7Z

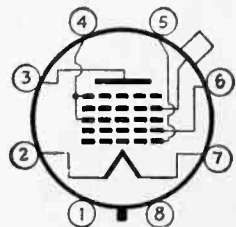

Type 6Z6 (MG)

FULL-WAVE high-vacuum rectifier, heater type, metal-glass envelope, seated height $3\frac{1}{8}$ inches, 7-pin octal base.

$E_A = 6.3$ v
 $I_A = 0.5$ amp
 E_{ac} (per plate, rms) = 350 v
 $I_{dc} = 50$ ma
Basing 7Q

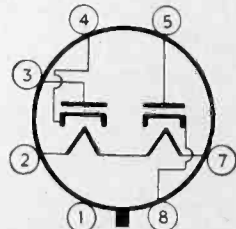

Type 6K6 (MG)

POWER amplifier pentode, heater type, metal-glass envelope, seated height, $3\frac{1}{8}$ inches, 7-pin octal base.

$E_A = 6.3$ v
 $I_A = 0.4$ amp
 $E_b = 250$ v
 $E_{c2} = 250$ v
 $E_c = -18$ v
 $I_b = 32$ ma
 $I_{c2} = 5.5$ ma
 $R_1 = 7600$ ohms
 $P_o = 3.4$ watts (11%)
Basing 7S

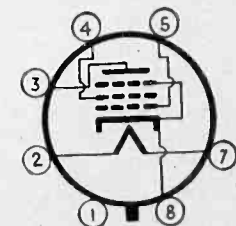

Type 6Q7 (MG)

DUPLEX-DIODE, high- μ triode, heater type, metal-glass envelope, seated height $3\frac{3}{8}$ inches, 7-pin octal base.

$E_A = 6.3$ v
 $I_A = 0.3$ amp
 $E_b = 250$ v
 $E_c = -3$ v
 $I_p = 1.1$ ma
 $\mu = 70$
 $r_p = 58,000$ ohms
 $g_m = 1200$ μ mhos
 Basing 7V

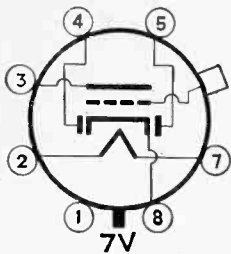

Type 6Q7

DUPLEX-DIODE high- μ triode, heater type, metal envelope, seated height $2\frac{9}{16}$ inches, 7-pin octal base.

$E_A = 6.3$ v
 $I_A = 0.3$ amp
 $E_b = 250$ v
 $E_c = -3$ v
 $I_b = 1.1$ ma
 $r_p = 58,000$ ohms
 $\mu = 70$
 $g_m = 1200$ μ mhos
 Basing 7V

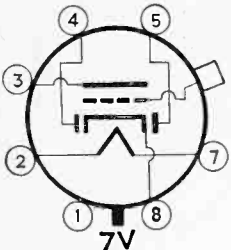

• • •

DISAPPEARING MICROPHONE ON BASEBALL DIAMOND



Paul Fair, umpire at the semi-professional baseball tourney held in Wichita, Kans., August 16 to 28, shown with microphone which rises near home plate when a foot lever is pressed. The microphone is used to make announcements during the progress of the ball games

**THIS RELAY IS
 SMALLER
 HUSKIER
 AND COSTS LESS!**

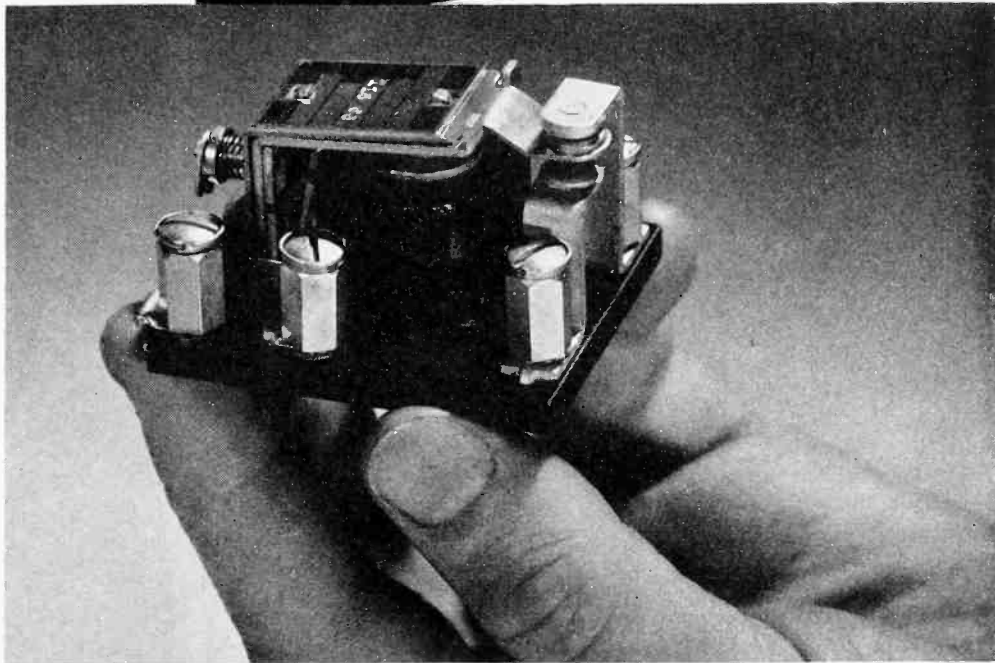

The design of the new Ward Leonard Little Giant Single Pole, Relay is simplicity itself. It is sturdily built yet there is not an ounce of material in it that is not essential to efficient performance. Measures only $1\frac{7}{8}$ " x $2\frac{5}{8}$ ". Controls $\frac{3}{4}$ H.P. on 115-230 volts. Ideal for heaters, pumps, compressors, signal lights, etc. Send for bulletins.

(WL) Relay Bulletins

Little Giant Relays.....	Bulletin 105
Midget Relays.....	Bulletin 106
Intermediate Duty Relays.....	Bulletin 81
Heavy Duty Relays.....	Bulletin 131 & 132
Sensitive Relays.....	Bulletin 251
Time Delay Relays.....	Bulletin 351 & 362

WARD LEONARD ELECTRIC COMPANY

Electric Control Devices Since 1892

Ward Leonard Electric Co., 32 South Street, Mount Vernon, N. Y.

Please send me bulletin describing.....

Name.....

Firm.....

Address.....

City..... State.....



Attention!

MANUFACTURERS OF TELEPHONE RECEIVERS AND HEARING AIDS —



Model 505 Artificial Ear and Model 300A Voltmeter

Manufacturers, research workers, otologists, service agencies and laboratories will find this combination ideal for accurately measuring the efficiency and frequency response characteristics of telephone and hearing-aid receivers under the same conditions which exist when the receiver is worn on the ear. The Model 505 Artificial Ear has been completely redesigned, simplified and reduced in cost. The Model 300A Electronic Voltmeter will be found extremely useful around the shop and laboratory for other measurements. Voltmeter range .001 to 100 volts, 10 to 150,000 cycles, logarithmic scale, AC operation. Adapters can be furnished for various types of hearing-aid receivers. In use by leading manufacturers and U. S. Government departments.

Send for Bulletin 6G

BOONTON **Ballantine Laboratories, Inc.** NEW JERSEY

ELECTROACOUSTICAL INSTRUMENTS

PERMANENT MAGNETS

ALL SHAPES — ALL SIZES FOR ALL PURPOSES

Stamped, Formed, and Cast; Chrome, Tungsten, Cobalt and **ALNICO**** (cast or sintered) under G. E. license.

THOMAS & SKINNER
STEEL PRODUCTS COMPANY

1116 E. 23rd STREET INDIANAPOLIS, INDIANA

Laminations for Radio Transformers — Tools
Dies — Heat Treating — Stampings

39 YEARS EXPERIENCE

WAXES • COMPOUNDS for ELECTRICAL INSULATION

Zophar offers prompt service on Insulating Compounds for a wide variety of electrical applications, including:

... insulation for CONDENSERS, TRANSFORMERS, COILS, power packs, pot heads, sockets, wiring devices, wet and dry batteries, etc. Also WAX SATURATORS for braided wire and tape. WAXES for radio parts.

Special compounds made to your order.

ZOPHAR MILLS INC.

130-26th St. Brooklyn, N. Y.

FOUNDED 1846

Type 25A6

POWER amplifier pentode, heater type, metal envelope, seated height $2\frac{1}{8}$ inches, 7-pin octal base.

$E_h = 25.0$ v
 $I_h = 0.3$ amp
 $E_b = 135$ v
 $E_{c2} = 135$ v
 $E_c = -20$ v
 $I_b(\text{zero signal}) = 37$ ma
 $I_{c2}(\text{zero signal}) = 8$ ma
 $R_l = 4000$ ohms
 $P_o = 2$ watts (9%)
Basing 7S

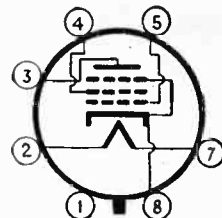

Type 6N6 (MG)

DYNAMIC coupled power amplifier, heater type, metal-glass envelope, seated height $3\frac{1}{8}$ inches, 7-pin octal base.

$E_h = 6.3$ v
 $I_h = 0.8$ amp
 $E_b(\text{output}) = 300$ v
 $E_b(\text{input}) = 300$ v
 $E_c = 0$ v
 $I_b(\text{output}) = 45$ ma
 $I_b(\text{input}) = 8.0$ ma
 $R_l = 7,000$ ohms
 $P_o = 10$ watts (5%)
Basing 7W

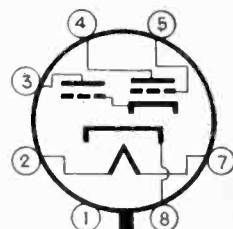

Type 6R7

DOUBLE diode pentode, medium-mu triode, metal shell, seated height $2\frac{1}{8}$ inches, 7-pin octal base.

$E_h = 6.3$ v
 $I_h = 0.3$ amp
 $E_b = 250$ v
 $E_c = -9$ v
 $I_b = 9.5$ ma
 $r_p = 8500$ ohms
 $\mu = 16$
Basing 7V

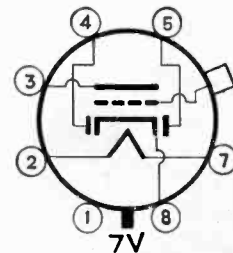

Type 25Z6

TWIN-DIODE high-vacuum rectifier, heater type, metal envelope, seated height $2\frac{1}{8}$ inches, 7-pin octal base.

$E_h = 25.0$ v
 $I_h = 0.3$ amp
VOLTAGE DOUBLER
 $E_{ac}(\text{per plate, rms}) = 117$ v (max)
 $I_{dc} = 75$ ma (max)
HALF-WAVE RECTIFIER
 $E_{ac}(\text{per plate, rms}) = 235$ v (max)
 $I_{dc} = 75$ ma (max)
 $E_{drop}(I_{dc} = 150 \text{ ma}) = 22$ v
Basing 7Q

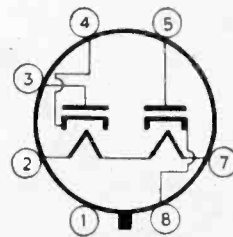

Type 6N7 (MG)

CLASS B twin triode amplifier, heater type, metal-glass envelope, seated height, $2\frac{3}{8}$ inches, 8-pin octal base.

$E_h = 6.3$ v
 $I_h = 0.8$ amp
 $E_b = 300$ v (max)
 $E_c = 0$ v
 $I_b(\text{zero signal}) = 17.5$ ma
 $R_l = 10,000$ ohms (plate to plate)
 $P_o = 10$ watts (approx)
Basing 8B

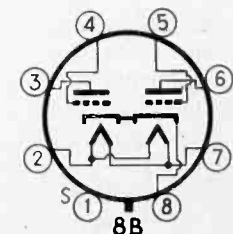

High-Voltage Indicator System

(Continued from Page 38)

indicate faulty operation consisted of a neon lamp and resistor connected so that the ionization current collected by a number of the rods (which were insulated from ground) was made to flow through the resistor to ground. The voltage drop across the resistor was sufficient to cause the neon lamp to glow when operation was normal. A short circuit or an open circuit in the system resulted in a decrease in ionizing voltage and a consequent reduction in current through the resistor. The neon lamp then ceased to glow. This method of obtaining an indication involved the added expense of insulating certain of the ionizing rods, additional installation wiring and required that no appreciable leakage be permitted to occur or the small current that was available would leak to ground through some path other than through the resistor. Another objection to this indicating system was that it supplied the same indication for short circuits that it did for open circuits.

An analysis of the circuit discloses the fact that the secondary terminal voltage of the high reactance transformer drops to nearly zero when a short circuit occurs and increases approximately five per cent above its full load value when an open circuit occurs. Here, then, is a means of obtaining an indication, although a rather impractical one, because the entire secondary winding is at high voltage above ground. However, the voltage of an auxiliary winding, wound on the same leg of the transformer core as the secondary and adequately insulated from the secondary, will vary with the secondary voltage and may be used to operate a suitable indicating system. It was proposed to have the voltage supplied by the pilot winding operate an under-voltage and an over-voltage relay connected so that the relay contacts could oper-

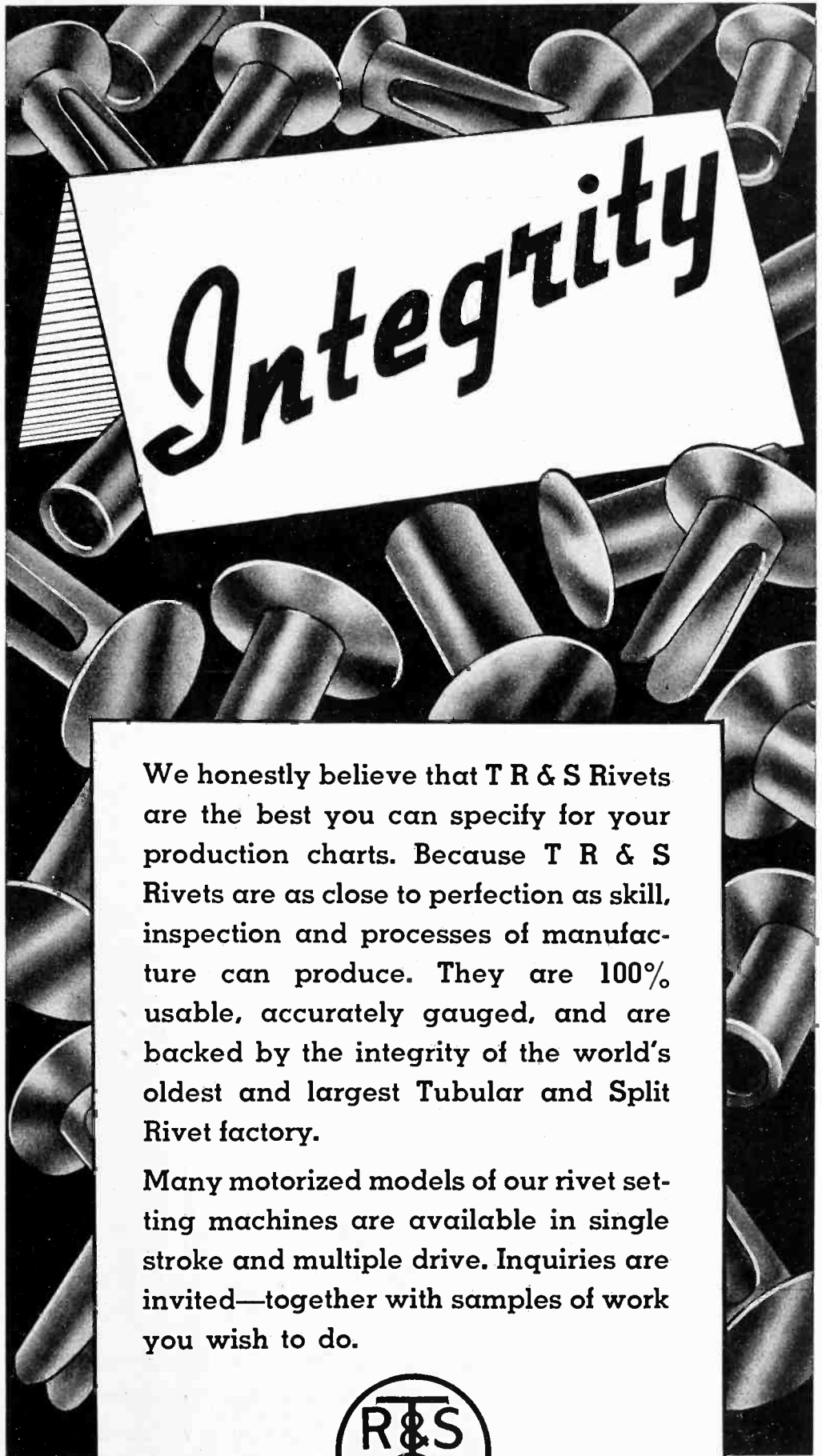

We honestly believe that T R & S Rivets are the best you can specify for your production charts. Because T R & S Rivets are as close to perfection as skill, inspection and processes of manufacture can produce. They are 100% usable, accurately gauged, and are backed by the integrity of the world's oldest and largest Tubular and Split Rivet factory.

Many motorized models of our rivet setting machines are available in single stroke and multiple drive. Inquiries are invited—together with samples of work you wish to do.

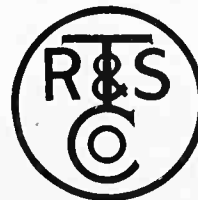

TUBULAR RIVET & STUD CO.

*World's Largest Manufacturers of Tubular
and Split Rivets*

WOLLASTON (Boston) MASSACHUSETTS
New York Chicago Detroit Indianapolis
San Francisco Nashville Dallas St. Louis

DESIGNED

FOR ACCURACY IN ELECTRIC CONTROL

RUGGED, COMPACT, LOW
POWER CONSUMPTION OF
1.5 WATTS, HIGH POWER
OUTPUT OF 2,000 WATTS

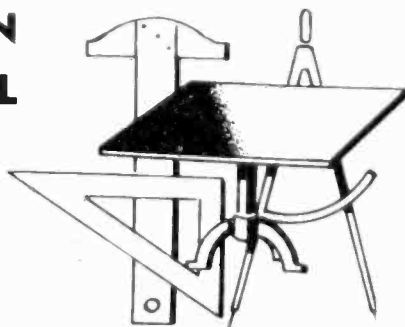
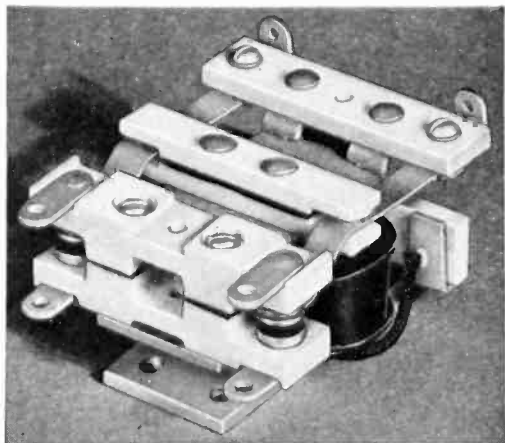

THIS KURMAN RELAY WAS
DESIGNED TO MEET THE NEED
FOR A HIGH QUALITY ME-
DIUM DUTY RELAY AT LOW
COST. THE MAGNET COIL IS
WOUND ON A BAKELITE
CORE AND ALSIMAG NON-
HYGROSCOPIC INSULATION
IS EMPLOYED. CONTACTS ARE
QUARTER INCH COIN SILVER.

KURMAN ELECTRIC CO., INC.
241 LAFAYETTE STREET
NEW YORK

STABILIZED A. C. VOLTAGE UP TO 25 KVA

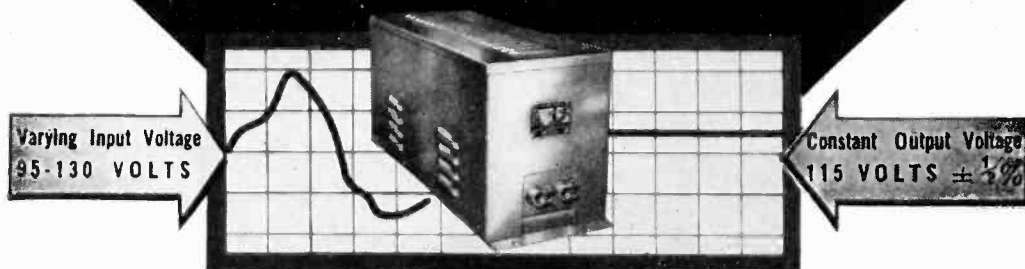

INSTANTANEOUS ACTION

NO MOVING PARTS

When a precision electrical device or a critical process is powered from an AC line, a Raytheon Voltage Stabilizer will permanently eliminate all of the detrimental effects caused by AC line voltage fluctuations. Made for all commercial voltages and frequencies, single or three phase.

Raytheon's twelve years of experience in successfully applying the Stabilizer to hundreds of perplexing voltage fluctuation problems is at your service. It will pay you to take advantage of our engineering skill.

Write for Bulletin DL48-71 JE describing Raytheon Stabilizers.

RAYTHEON MANUFACTURING CO.
100 Willow Street, WALTHAM, Massachusetts

ate suitable indicating lamps. This could undoubtedly be done but a relay which will operate on a five per cent increase in voltage is quite expensive.

Therefore, the pilot winding is used in conjunction with a relay to indicate the short-circuited condition only. The relay is closed in normal operation and will drop out when a short-circuit occurs. Its contacts are so connected that a green indicating lamp lights when it is closed and a red indicating lamp lights when it drops out. To supply the open-circuit indication, a relay with a series coil, current operated, is connected in series with a primary lead of the transformer. This relay is adjusted so that it pulls in on normal load and drops out if an open-circuit occurs in the high voltage system. Its contacts are connected so that when it drops out the red indicating lamp is lighted. The operation of this system, then, is that for normal operation the green lamp is lighted. When a short circuit occurs the green lamp is out and the red lamp is lighted. When an open circuit occurs both lamps are lighted. Thus an indication is supplied which shows what to look for if the Precipitron is not operating normally. The relays are adjustable so that proper operation may be obtained over the complete load range of the power pack.

The advantages of the system are: No extra wiring is necessary to install it, it is self-contained in the power pack, it operates at low voltage so that relays with standard 115-volt insulation may be used, it is reliable in operation since an adequate amount of energy is always available for its operation and 150-volt lamps operating on 115 volts insure long life for the indicating lamps, the power packs may be placed in stock as a complete unit. indication of both the short circuit and the open circuit condition is furnished, it is less expensive than the system it replaces when the extra manufacturing cost of the ionizers required by that system and the extra wiring it involves are considered, and it is an easy matter to secure an indication at a remote location by connecting another red and green lamp in parallel with the lamps in the indicating system described.

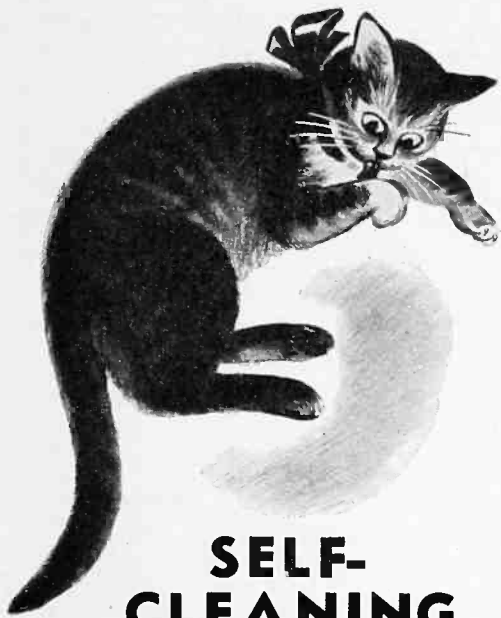

SELF-CLEANING

Remler Attenuators—smooth as cream and they clean themselves! Silver contacts (.030" solid silver) machined to precision, "floated" on ball bearings. Self-cleaning because soft, thin silver oxide automatically wipes off with the blade! Always quiet, even in low-level circuits. It's a pleasure to mix with Remler Attenuators. Write for complete specifications.

REMLER COMPANY, Ltd.

19th at Bryant San Francisco

RESISTANCE TUNED AUDIO OSCILLATORS

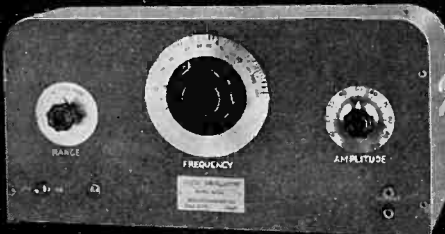

LOW DISTORTION—less than 1% for distortion measurements on high quality audio equipment and broadcast transmitters.

EXCELLENT STABILITY—saves time because NO ZERO SETTING necessary.

WIDE FREQUENCY RANGE—models available from 5 cps. to 200,000 cps.

HIGH OUTPUT—models available with 1 to 5 watts output.

INEXPENSIVE—the Model 200B, 20-20,000 cps., 1 watt output—only \$85.80 net f.o.b. Palo Alto, California.

Write for complete information about these and other instruments

HEWLETT-PACKARD CO.

481 Page Mill Road • Palo Alto, California

Color Television Demonstrated By CBS

(Continued from page 34)

ning circuits were driven at 120 cps, the horizontal at 20,580 cps (343 x 60).

At the receiver a similar disc about 20 inches in diameter is used, mounted within a standard cabinet so that the shaft driving the disc lies parallel to and just adjacent to the cathode ray tube. The cathode-ray tube itself, which was built in the C.B.S. laboratories, is nine inches in diameter. It employs magnetic focus and deflection, and a sulphide screen made especially for projection tubes. The electron gun produces a beam current several times as great as that usual in receiver tubes, without increase in spot size. A brighter than ordinary image is thereby produced. The second anode voltage is 7000 volts, the first anode voltage about 5000 volts. The power supply for the tube is a standard unit taken from a commercial receiver. The cabinet is of the direct-viewing type. An 1800 rpm motor and 6-to-4 gear reduction unit were used to drive this disc at 1200 rpm. Synchronism between the two discs was maintained by the use of a common alternating-current supply.

The shape of the segments in the receiving disc is dictated by two factors. First, when a segment is in front of the cathode-ray tube screen, its leading edge must cover at any instant the position of the scanning spot at the same instant. Moreover as the disc rotates, the filter must continue to cover that spot until the fluorescent decay of light has been substantially completed. These two considerations have led to the shape of filter segment shown in the accompanying illustration. Sufficient safety factor has been included in the area of the segment to allow for phase variations in the synchronization up to 10 or 15 electrical degrees. A disc large enough for a 12-inch tube is now being constructed.

In commercial practice, synchronization by the use of a common alter-

HIGHER FIDELITY

is

Built into

FAIRCHILD'S

Distortion Free

AMPLIFIER!



A Feed-Back Amplifier Flat within .3 Decibel from 15 to 15,000 Cycles!

Precision-built by Fairchild laboratory engineers, the new Unit 246 Feed-Back Amplifier provides greater fidelity for broadcasting, recording, playbacks, and laboratory work.

Fits 19½" relay rack—7" high panel. 2 Units—amplifier and power supply each this size.

SPECIFICATIONS PROVE UNIT 246 AMPLIFIER'S PERFORMANCE

Overall gain—75 decibels.
Noise level—50 decibels below "0" level.
Rated at 23 watts into 500 Ohm resistive load.
Input impedance Multiple line: 50, 125, 200, 500 Ohms.
Output impedance: 16 and 500 Ohms.
Input line volts: 110-125V; 50-60 cycles AC.
Distortion: .3% at rated output.

Write for descriptive literature today!

"...it had to satisfy Fairchild first"



**"The Price is Low . . . It Meets the Specs!
Why Shouldn't I Buy It?"**

• Under present day conditions more than ever before "Low Price" and "According to Specs" may prove by far the most costly product in the long run!

• *The Best Buyer in the Whole World—the U. S. Government—is NOW Considering:*

1. The FINANCIAL RESPONSIBILITY of the supplier? The ability to post a bond is not necessarily sufficient, but . . .
2. More important is the MORAL RESPONSIBILITY of the supplier! Does the product FULLY meet the requirements in every way from the outset and without modification or rebuilding? Is the actual delivery date as good as the quoted date?
3. Does the manufacturer enjoy a high reputation in the industry for HONESTY, INTEGRITY and FAIR DEALING?
4. QUALITY and SERVICE are of paramount importance!
5. The supplier should make a fair profit.

• *The FERRANTI name was built on service and has survived for over 60 Years on the basis of principles listed above and we welcome the opportunity of justifying your confidence.*

**FERRANTI
PRODUCTS**

Transformers for every electronic, sound, communication, industrial, and laboratory use — miniature aero transformers for aircraft and portable work — high power plate and filament transformers — filters, equalizers, modulation sets, rectifiers, etc. — electrostatic voltmeters, portable voltmeters, ammeters, phase rotation indicators, special testing equipment, and numerous other instruments.

Ferranti ELECTRIC INC.
R.C.A. BUILDING, NEW YORK, N. Y.

Vacuum Tube Protection

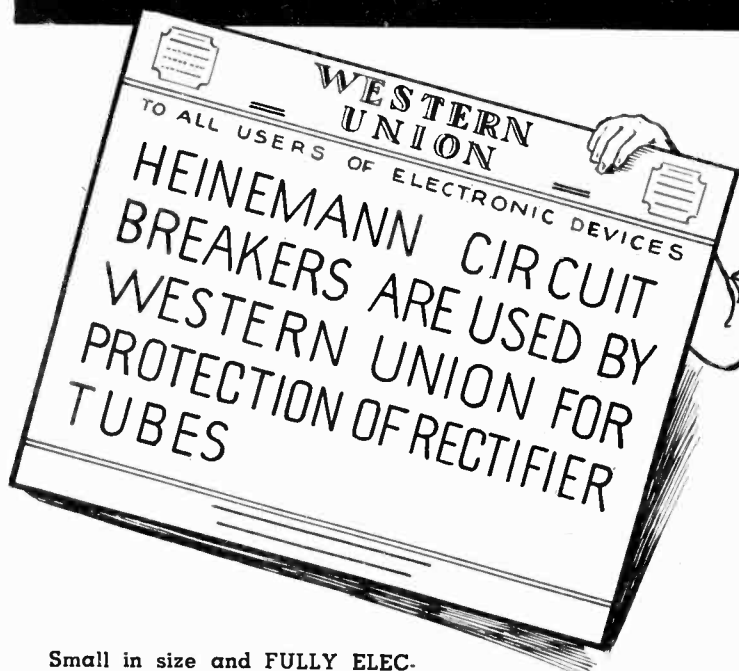

Small in size and FULLY ELECTRO-MAGNETIC this auxiliary breaker provides for economical and positive built-in protection against dangerous overloads and short circuits.

Exclusive Features:

In any rating or fractional rating from 50 milliamperes to 50 amperes.

Immediate reclosing after device has opened after overload or short circuit.

Will operate in temperatures from 40° F. to 240° F.

Increases life of tubes; reduces costly replacements.

HEINEMANN CIRCUIT BREAKER CO.
97 PLUM ST. - - - - TRENTON, N. J.

nating current supply is not always feasible, nor desirable even when a common a-c system is available. Independent synchronization of the receiver motor can be obtained from the television signal sync pulses, which are used after suitable amplification to drive a small phonic motor which operates in tandem with the main drive motor. Calculations indicate that a single type 6L6 tube is sufficient to drive the phonic motor.

One of the mechanical design problems is that of reducing the noise associated with the motor, gear-reduction unit, and the windage caused by the motion of the disc through the air. While the receiver was quite noisy during the demonstration, the noise has been greatly reduced since that time, and there is no reason why this problem should not yield to straightforward mechanical design and sound-insulation technique.—D.G.F.

**COMMUNICATES SIX
WAYS AT ONCE**



George A. Mead, New York State Commander of the American Legion in a recent broadcast from G. E. Co.'s television studios, during which his voice was carried over every known scientific means of voice communication, according to General Electric engineers. His voice, in addition to going out on the ultra-short wave band accompanying the television picture, was simultaneously carried by WGY on 790 kc., by WGEO on 9530 kc., by W2XB (television) on 77.75 Mc., by frequency modulation over W2XOY on 43.2 Mc., and over a light beam on 430 to 750 million megacycles, in addition to the wire telephone operating at frequencies of 150 to 2500 cps.

THE ELECTRON ART

Among the subjects reviewed in the technical literature this month are u-h-f receiver for meteorography photocells in temperature measurements, an electronic integrator, and frequency modulation for emergency communication

U-h-f Superheterodyne Receiver for Direction Finding

A U-H-F SUPERHETERODYNE receiver was especially designed and built to operate at 1.67 meters for the reception of weak signals emitted from a small radiometeorograph transmitter sent aloft by sounding balloons. It is described by Messrs. Luke C. L. Yuan and Charles E. Miller in the September 1940 issue of *The Review of Scientific Instruments*. Stability and sensitivity are essential characteristics of this receiver. The receiver consists of two units, a converter unit and a high gain resistance coupled intermediate frequency amplifier together with diode detectors and a vacuum-tube voltmeter. The frequency range of the i-f amplifier is flat over a range of 110 kc, thus allowing for any slight variation in the oscillator frequency or signal frequency due to temperature variations, etc. without affecting the output of the receiver.

The converter unit consists of a 956 r-f amplifier, a 954 mixer and a 955 oscillator. The tuning condensers C_2 are National UM-50 cut down to two rotor plates and one stator plate. Relatively large trimmer condensers C_1 are used to give a band spread effect to the tuning. All coils are one and one half turns of No. 20 phosphor bronze wire, $\frac{1}{4}$ inch in diameter. The

length of each coil is about $\frac{1}{4}$ inch. Slight variations are necessary to match their inductances. A grounded Faraday screen electrostatically shields the inductively coupled antenna coil from the radio frequency coil. The plate of the radio frequency tube is capacitively coupled to the grid coil of the mixer stage at the point one-half turn down from the grid end. The suppressor grid of the mixer tube is connected directly to the grid of a conventional triode oscillator. The tap on the oscillator coil is about one-half turn up from ground. The different stages are assembled in shielded compartments as shown by the dotted lines in the Figure. The tuning condensers are ganged together with Pyrex rods and universal Isolantite couplings. If metal shafts are used for ganging at these ultra-high frequencies enough energy is transmitted through the shields by them to produce instability. All filaments, plates and screen grids are isolated from external circuits by chokes and by-pass condensers. Small mica condensers are built into the tube sockets where radio frequencies must be bypassed to ground.

The i-f amplifier consists of four resistance coupled stages. An 1851 and two 1852 high- μ tubes drive a 6J7 connected as a triode. This will deliver seven volts to the diode before overloading. The overall amplification of this amplifier is approximately 110,000 at 220 kc. A 6R7 is used as

the combined detector and vacuum-tube voltmeter. One of the diodes is coupled directly to a phone plug, while the other is coupled to the grid of the triode section which serves as a d-c amplifier in the vacuum-tube voltmeter circuit.

When receiving a signal from a single 955-tube transmitter with a plate input of one watt over an optical path of 30 miles, the signal is strong enough to develop an intermediate frequency voltage of 16 volts on the plate of the 6J7. The frequency range is from 1.64 meters to about 1.98 meters. The tuning is sharp and smooth and no more critical than average broadcast receivers. The calibration and overall performance are quite stable through the variations in temperature and humidity, and rough handling encountered in field measurements over an extended period of time.

• • •

Temperature Measurement With Photo Cells

THE MEASUREMENT OF HIGH temperatures using rectifier type photocells is described by B. M. Larsen and W. E. Shenk in the August 1940 issue of the *Journal of Applied Physics*. The discussion applies specifically to temperature measurement problems in a steel plant, but certain aspects have considerably wider application. The authors have used a rectifier type photo cell instead of the vacuum or gas photo tube because it is considerably more rugged and it supplies its own potential or current. The response curve of such a photo cell will form a rapidly expanding temperature scale with increasing accuracy toward the higher temperatures. This makes possible a high degree of precision within a limited span near the top of any given temperature range, especially at the higher temperatures. This is useful in the control of processes in which certain narrow optimum temperature range is involved in some manner. The response to temperature changes is rapid, thus making possible measure-

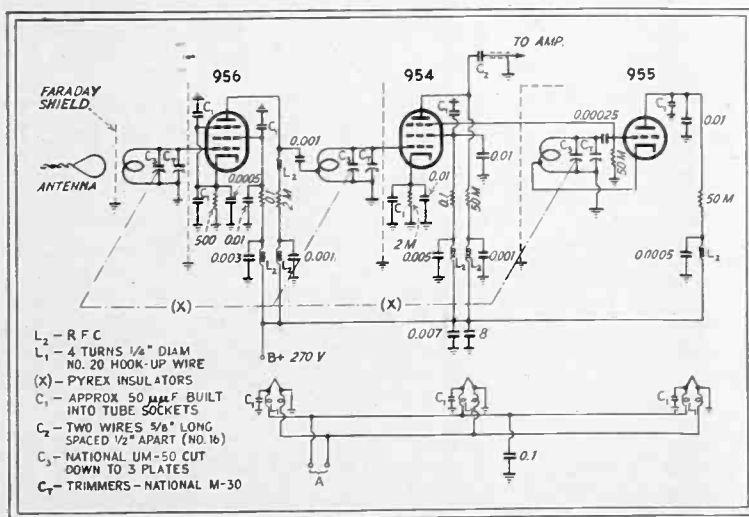

Circuit diagram of the converter section of the superheterodyne receiver operating at 1.67 meters

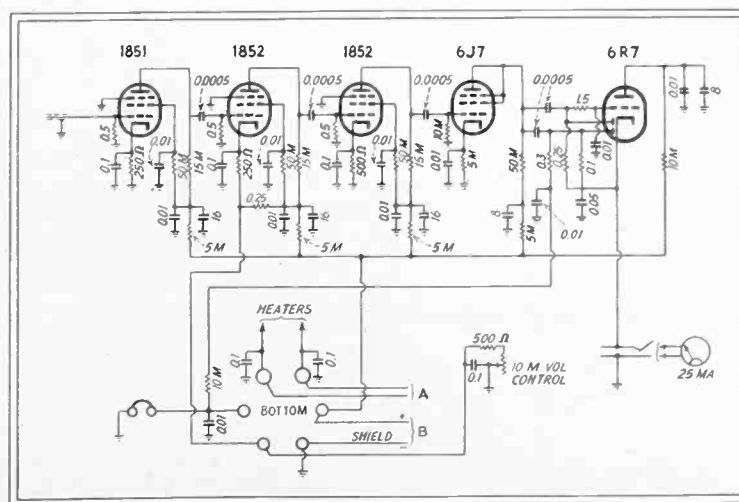

The i-f amplifier and detector. Reliable signals were received from a one-watt transmitter at thirty miles

*Command
Performance*



LINGO

**VERTICAL RADIATORS
are "Engineered"
to give you the per-
formance you de-
mand . . .**

Engineers are quick to recognize a product that proves itself by performance. We feel proud that Lingo Radiators are setting new standards for performance and efficiency and that alert engineers everywhere are being convinced by actual installation results. In most cases results are superior to what was anticipated. If this sounds "good if true" we invite you to write and let us provide you with the facts that prove **EXCEPTIONAL HIGH EFFICIENCY . . . LOW MAINTENANCE COST . . . EXCELLENT STABILITY . . .** and a **5-YEAR INSURANCE SAFEGUARD!**

Free Technical Data

We will be glad to make free recommendations, quote prices and give you the facts as they apply in your case. In writing, please give location, power and frequency of station.

**JOHN E. LINGO
& SON, INC.**

Dept. E-10 CAMDEN, N. J.

LICENSED MANUFACTURERS OF
PATENTED TURNSTILE AN-
TENNAS FOR FM

LINGO
VERTICAL
TUBULAR STEEL
RADIATORS

ments of rapidly varying temperatures for measurements having a short period of exposure.

However, there are certain disadvantages to photocells of this type for these measurements. They become unstable at temperatures greater than 120 degrees F. or 50 degrees C. In taking precautions to keep them relatively cool, the temperatures of two sources of heat must be considered. They are the ambient temperature and the surface temperature being measured. If the ambient temperature is high, there is a small margin of safety and the incident radiation from the measured surface may overheat the face of the cell. The ambient temperature may be reduced by air or water cooling and the heat from a measured surface reduced by using a small diaphragm opening or a filter to absorb the infrared radiation.

In some cases the widespreading scale mentioned above may be a handicap because a wide range cannot in general be covered. Also the radiation path must be kept free of obstacles, such as smoke or fumes, and there should be no possibility of reflection from the surfaces of the cell mixture. The photocell is also subject to a slight amount of fatigue. In the application of the photocell to temperature measurement, these disadvantages have been recognized and satisfactory op-

. . .

**RADIO AIDS LONG
RANGE WEATHER
FORECASTING**

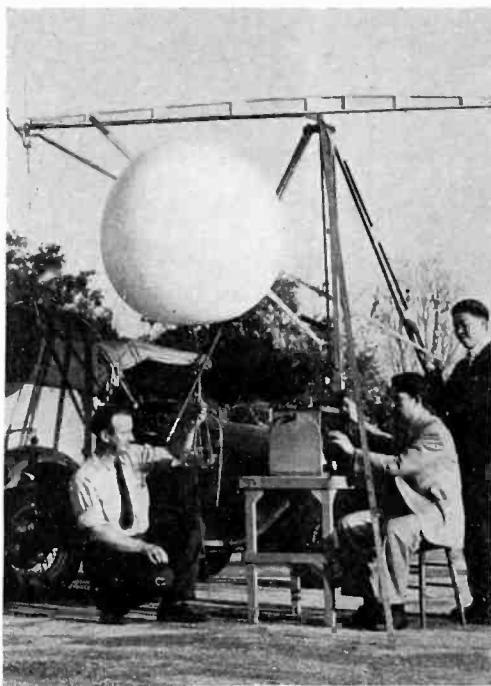

Dr. Irving P. Krick (center), C. E. Miller (left) and C. L. Yuan about to send up a radio-sonde balloon with its associated transmitter for the determination of meteorological data for weather forecasting. Since the fall of 1936, Dr. Krick has been forecasting weather by means of the air-mass analysis method at the California Institute of Technology at Pasadena

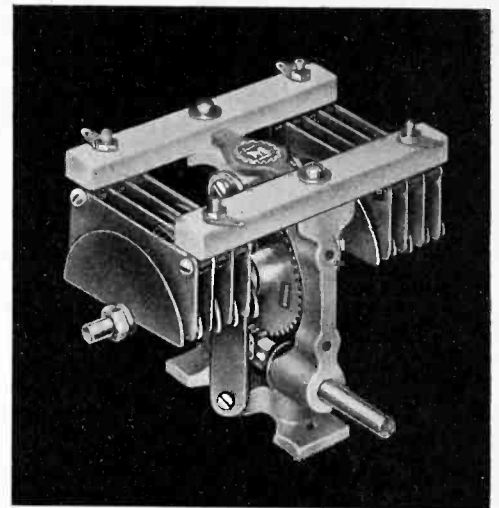

**Designed for
Application**

Outstanding features of the MILLEN transmitting condensers include: rugged cast aluminum frame, right angle self locking worm drive, center fed rotors and stators, heavy round-edge polished aluminum plates, and genuine Isolantite dielectric. Available in capacities of 35, 50, and 70 mmfd per section with peak break down voltage rating of 3000.

Catalogue Upon Request

JAMES MILLEN MFG. CO. INC.
150 EXCHANGE ST. MALDEN, MASS.



**Small but Mighty
EICOR MOTOR
for Special Applications**

Here's another outstanding example of the small lightweight Eicor "2310" D.C. motor with Series AN connector engineered for continuous duty in special application. 1/30 HP. Assures dependable, trouble-free performance. Write today for data on Eicor Motors to meet your exact need.

EICOR INC.

517 S. Laffin Street, Chicago, U.S.A.
Export: AD AURIEMA, INC., 118 Broad St.,
New York, N. Y. Cable: Auriema, New York

eration has resulted. The authors describe a photocell fixture designed by them for use in measuring temperatures on the roof of an open-hearth furnace. They say that this is one of the most severe applications and many difficulties are present which would not have to be considered in other applications. The fixture is water cooled and the stainless steel diaphragm tube is arranged with baffles so that no radiation is reflected from its wall. An inexpensive watch glass prevents occasional flying steel or slag particles from damaging the instrument. It can easily be removed for replacement. The fixture also contains an infrared filter to absorb such unwanted radiation.

• • •

Reversed Speech

A VERY INTERESTING DISCUSSION on the properties of speech is presented by E. W. Kellogg in the July, 1940, issue of the *RCA Review*. While this article may not have any direct value to many engineers, it will certainly be worth while to any one who is concerned with the transmission or recording of speech. For others it will serve as excellent background material.

Listening to reversed speech by playing a recording backward has its scientific values as well as being a source of amusement. It brings home in a striking manner various characteristics of our speech, of which we are almost entirely unaware. Also, a num-

• • •

DEFENSE STRESSED THROUGH SCIENCE



Prof. W. L. Everitt, Ohio State University radio authority, studying the construction of an iconoscope at the Armour Institute of Technology at Chicago where defense classes are being held

GOD-FATHER TO A

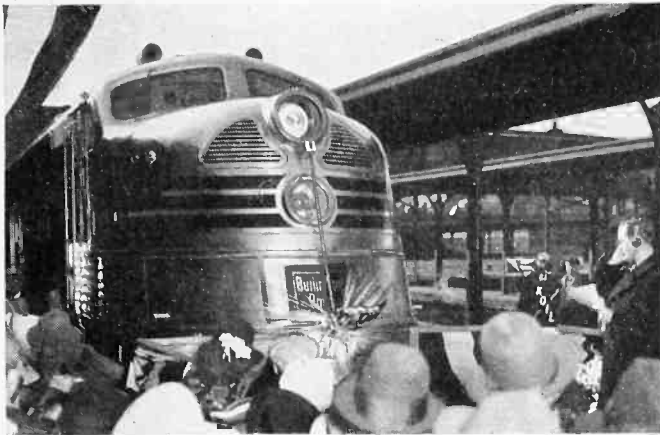

Equipment by E. W. Applebaum—Photo Courtesy Burlington R. R.

★ Racing across the Nebraska prairie at 75 miles an hour, the "Pioneer" Zephyr gives out with a long blast. A half dozen jack rabbits in the immediate neighborhood shift into high.

In Omaha—160 miles away—a crowd cheers as a champagne bottle smashes against the prow of the new "Silver Streak" Zephyr.

What's the connection? Relays by Guardian! The sound impulse picked up and transmitted by short wave, actuated a Guardian Control Assembly which smashed the bottle and launched another Burlington Streamliner.

Your control problem may involve distances of inches . . . or fractions of an inch . . . instead of miles. Your mechanism may operate 100 times a minute instead of once in a lifetime, and crowds may never gather to see it happen. But no matter how simple or how complex . . . you can depend on *Relays by Guardian* to do YOUR job . . . economically and effectively. Ask us to offer cost-free engineering suggestions. Send a chart or diagram.

Initial Your Letterhead for Big New Catalog "E" Today.

GUARDIAN  **ELECTRIC**
1625 WEST WALNUT STREET CHICAGO • ILLINOIS

JOHNSON *Built..*

**Advanced DESIGNING
Skilled ENGINEERING
Precision MANUFACTURING**

Broadcasters, Consulting Engineers, Manufacturers—all appreciate the technical assistance they receive from JOHNSON. Whether the requirement is phasing equipment for a broadcasting station—special parts for some particular application by a consulting engineer—or complicated specifications to be met by a manufacturer, let JOHNSON help.

Write for
Commercial Catalog
301D



E. F. JOHNSON CO

WASECA, MINNESOTA

EXPORT: 25 WARREN ST., NEW YORK, N. Y.

"MANUFACTURERS OF RADIO TRANSMITTING EQUIPMENT"

**RELAYS
By
GUARDIAN**



**Series 110 AC
Relay**

One of "Guardian's" complete line of electrical control units turned out in volume production from 3900 standard parts. Any quantity as you want them—when you want them.

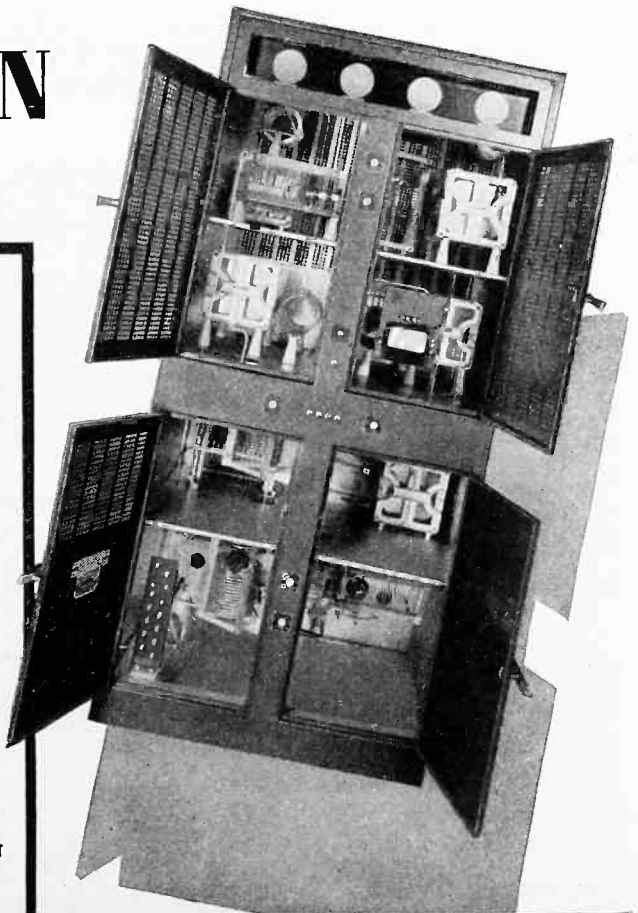

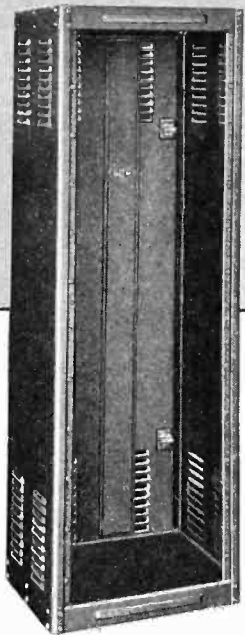

Complete **PROTECTION**
plus Outstanding
APPEARANCE!

*There's a BUD CABINET
RACK to house EVERY
TYPE of ELECTRONIC
INSTALLATION*

Note these features:-

- Heavy Steel Construction.
- Made in 17 different styles and sizes.
- Hinged full-length rear door.
- Interlock switch provisions included.
- Either or both sides available with or without louvres.
- Furnished in either Grey or Black baked crackle finish.
- Panels fit flush with cabinet front.
- Complete line of accessories available including Dollies, Interlock switches, Mounting angles, Panels, Chassis, etc.

Additional information available upon request.



BUD RADIO, INC.
CLEVELAND, OHIO



RESISTOR PROBLEM?

Let us help you solve it!

● The many types of Global Ceramic Resistors are solving difficult resistance problems every day. Our competent staff of engineers are at your service without obligation.

When writing please include such information as—
diagram of circuit, function of resistor, physical limitations and electrical specifications.

GLOBAL DIVISION
THE CARBORUNDUM COMPANY, NIAGARA FALLS, N. Y.

REG. U. S. PAT. OFF.

(Carborundum and Global are registered trade-marks of
and indicate manufacture by The Carborundum Company)

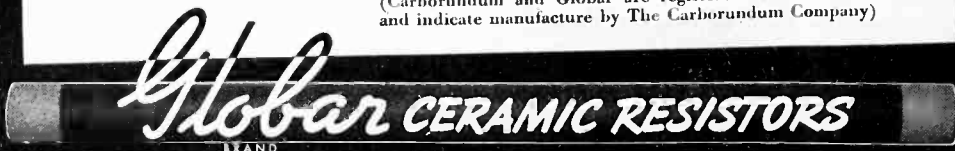

ber of principles which might be predicted from purely theoretical consideration are confirmed. A listener's first impression on listening to reversed speech is that the speaker is speaking a foreign language, very rapidly. The strange inflections suggest some foreign language with which we are very unfamiliar and few of the sounds are recognizable. This is also true after considerable experience. This is explained by the fact that many sounds are slighted or inexact substitutions are used. The author makes the comparison that a mother can identify her baby in spite of a very dirty face. Similarly, we can recognize familiar words provided a reasonable fraction of the characteristics are present. Also, we understand speech by recognizing whole words and not by a laborious synthesis of a succession of sounds. To illustrate how we may give incorrect values to some sounds without appreciable effect on intelligibility, the author once attempted to figure out how many ways Schenectady might be spelled without noticeably changing the pronunciation. His startling answer was 1,125. The author also discusses the reversal of singing and instrumental music. He says that one's ability to recognize an instrument producing certain tones is cut to about 20 per cent of normal. Reversed piano music sounds very much like organ music or accordion music. This and other reversed music show that the attack and starting transients of a sound are probably more important in recognizing the instrument than the quality of the sustained sounds themselves.

• • •

PARALYZED BOY GETS LESSONS BY PHONE SYSTEM

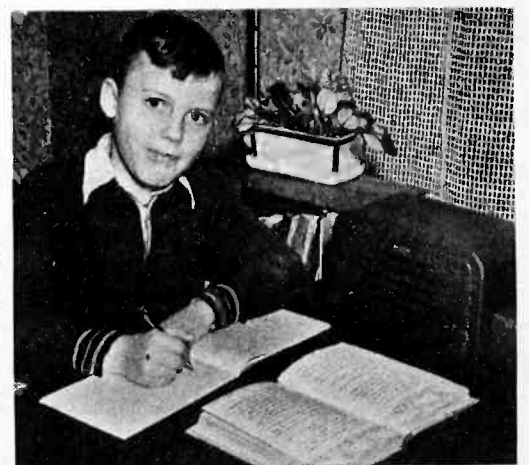

James Spears, 11 year old London, Ontario, school boy, confined to his home because of creeping paralysis attends school at the Ryerson Public School by means of an intercommunicating system which enables him to keep up with his classmates. London is the second large city in North America to try out this means of education

MADE BETTER TO
WORK BETTER



• The combination of high tensile strength that assures a lasting bond, and faster, cleaner work made possible by quick-acting flux of pure water-white rosin, has given Gardiner Rosin-Core Solders an outstanding reputation for efficiency and economy on radio work by expert or amateur. Yet, due to modern production methods and big sales, Gardiner Solders cost less than even ordinary kinds. Made in various alloys and core sizes . . . and in gauges as small as 1/32 of an inch . . . in 1, 5 and 20-lb. spools.



4889 S. Campbell Avenue Chicago, Ill.

NEW TERMINALS *With Wide Range Utility*

No. 140 SERIES

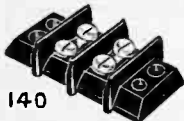

140



141

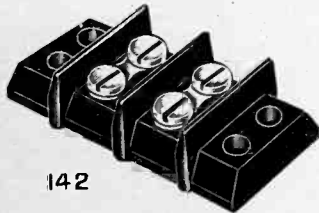

142

Made in three sizes as shown above. Barrier strips not only make a long leakage path, but prevent direct shorts from frayed wires at terminals. Molded bakelite insulation.

Terminals, Terminal Panels, Plugs, and Sockets made to your specifications.

Write for prices and samples.

HOWARD B. JONES
2300 WABANSIA AVENUE,
CHICAGO ILLINOIS

Electronic Integrators

AN INTEGRATING INSTRUMENT developed for biologists who work with bioelectrical phenomena (action currents) of nerve and muscle tissues is described by G. L. Freeman and E. L. Hoffman in the September 1940 issue of *The Review of Scientific Instruments*. The principle involved can undoubtedly be used in other applications. The circuit diagram is shown in the accompanying figure. The al-

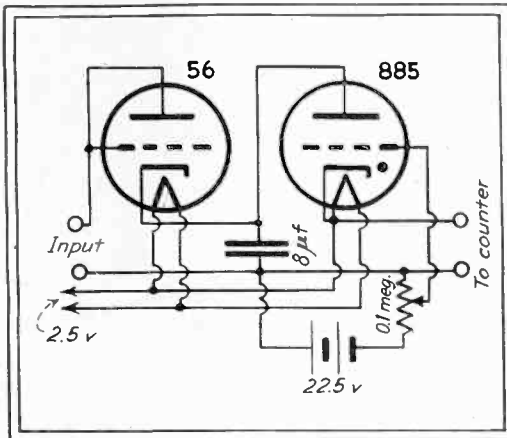

Circuit diagram of the electronic integrator

ternating electrical disturbance from an amplifier is fed to a type 56 tube connected as a diode. It is rectified into d-c impulses which accumulate on the 8 μ f condenser where they are stored until the condenser contains enough energy to discharge the gas-filled tube (885). The output of the 885 is used to operate a counter. A comparison of the output of the integrator and the record of an oscillo-

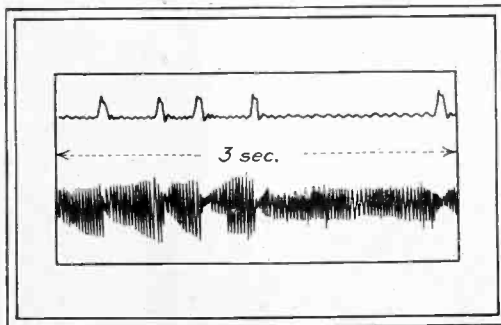

Comparison of the output of the integrator and output of an oscillograph connected to the same source

scope connected to the same current is shown in the diagram. The integrator discharger shown on the upper line is more rapid when the oscillographic record shows an increase in the number and amplitude of action currents.

• • •

Frequency Modulation for Emergency Communication

THE USE OF FREQUENCY MODULATION in police radio systems is described by Herbert DuVal, Jr. in *The APCO Bulletin* (The Associated Police Com-

HERE ARE THE

Facts

ABOUT GARRARD RECORD CHANGER DELIVERIES

You have heard rumors that Garrard Record Changer production has stalled, because Britain is at war. We want you to know that today Garrard, in America, has ample stocks. New Garrard models are arriving regularly. Garrard accepts their responsibility to you and intends to deliver as many Record Changers as you can sell. That's our answer to these rumors.

GARRARD IS YOUR GREATEST PROFIT OPPORTUNITY

No other Record Changer can match the smooth, silent, precision performance of Garrard. It's a luxury instrument, frankly designed for quality buyers — your "best" customers who demand the finest and will consider nothing less. Here lies your greatest profit opportunity. A rich, ripe market — easy to sell when you have what it wants, and consequently, easily sold on Garrard.

GARRARD GREATER PROMOTIONAL HELP

in national magazines and on your counters — at the point-of-sale — will make your selling job easier than ever. For complete information about the entire Garrard line — the facts on why it is your greatest profit opportunity — get in touch with your jobber or write direct to . . .

GARRARD SALES CORP.
296 BROADWAY, NEW YORK, N. Y.

GARRARD

*the world's finest
record changer*

THE CHANGER YOU WOULD WANT
YOURSELF . . .

The practical data you need
are in this book

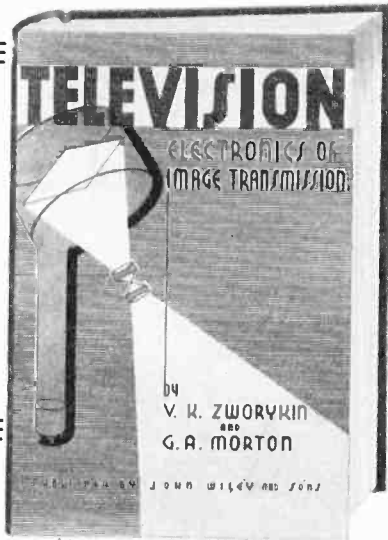

YOUR book on the important principles of television, written in engineering language by men who know whereof they speak

ZWORYKIN AND MORTON'S TELEVISION

Published 1940

Note these features:—Fundamental physical principles involved in electronic engineering: electron emission from solids (i.e., photoelectric emission, thermionic emission, secondary emission, shot effect, etc.), electron optics, and fluorescent materials. Analysis of fundamentals of picture transmission and resolution. Various forms of pickup tubes, viewing tubes and other electronic terminal tubes used in television. Problems of video amplification, radio transmission and reception, etc. The description of a practical television system: the RCA NBC television project.

"This book is indeed an excellent exposition of the present state of the art and will probably become a classic in its field . . . I am recommending the text to my friends and associates in the communication industry as the most complete and authoritative treatment of this subject which I have seen."

—PROFESSOR JOHN R. MARTIN,
Case School of Applied Science

646 pages 6 by 9 \$6.00

ON APPROVAL COUPON

JOHN WILEY & SONS, Inc.
410 Fourth Avenue, New York, N. Y.

Kindly send me a copy of ZWORYKIN AND MORTON'S "TELEVISION," on ten days' approval. At the end of that time, if I decide to keep it I will remit \$6.00 plus postage; otherwise, I will return the book postpaid.

Name

Address

City and State

Employed by E-10-40

munication Officers). One of the main difficulties of radio transmission in police communication systems has been the high noise levels occurring in business districts, particularly during heavy traffic periods. At times these conditions have completely disrupted communication with even the best of amplitude modulation equipment. Another factor contributing to the high noise level is that every mobile unit carries its own source of interference with it—its ignition system. The newer a-m receivers have incorporated in them noise balancing circuits and other devices to reduce the interference electrically within the receiver. This, however, has not been entirely satisfactory.

The reduction of noise with frequency modulation gives two major benefits to the users of emergency radio communication. It produces a higher signal-to-noise ratio and it increases the radius of communication. There are present in u-h-f amplitude modulation systems certain dead spots in the service area. This may not be caused by a low signal in that area, but may be due to the setting of the squelch circuit which has been turned up to eliminate background noises during non-transmitting periods. Frequently, these dead spots can be eliminated by reducing the noise level below the signal level, so that greater receiver sensitivity can be used. Frequency modulation does this and thereby increases the reliability of the system.

A diagram in the article shows the range obtained under average conditions with frequency modulation. The mobile antenna height above the

• • •

DEFOREST OBSERVES BIRTHDAY DISCUSSING TELEVISION PLANE



Dr. Lee DeForest recently observed his 67th birthday by discussing his latest invention, a pilotless television torpedo plane which is now being tested at Wright Field. Here Dr. DeForest is conferring with U. A. Sanabria, president of the American Television Laboratories

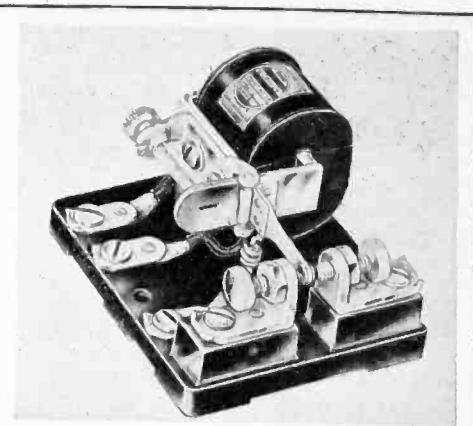

ALLIED CIRCLE SENSITIVE RELAY

The Circle line of relays is a new addition to the growing line of Allied quality relays.

Rugged, precision made, assembled on moulded Bakelite base—has many mechanical and electrical features that assure long life under the most severe operating conditions.

Suitable for thermal regulators, electronic devices, ultra sensitive control circuits; in low current supervised circuits such as burglar and fire alarms, voltage control circuits, keying, tuning devices, etc. Operating characteristics—for A.C.—as low as one mill at 110 volts, 60 cycles with a 50% drop out value; for D.C.—as low as .012 watts with 80% drop out value.

Dimensions—over-all 2 3/8" wide; 2 3/4" long; 1 3/4" high

Also manufacturers of a complete line of relays for all communication and electronic uses.

Write for complete descriptive literature and prices.

ALLIED CONTROL CO., INC.
227 FULTON STREET NEW YORK CITY
Export Department:
Pan Mar Corp., 1270 Broadway, New York City

TIME DELAY! SYNCHRONOUS MOTOR DRIVEN

- LOWEST PRICED MOTOR DRIVEN TIME DELAY RELAY
- QUICK VISIBLE DIAL SETTING
- EXTREMELY RUGGED CONSTRUCTION
- SPLIT SECOND ACCURACY
- INSTANTANEOUS AUTOMATIC RESET

Series TD-60 size, mounted in case 5" x 5" x 2 3/4", contact rating 1500 watts non-inductive

LIST

\$20.00

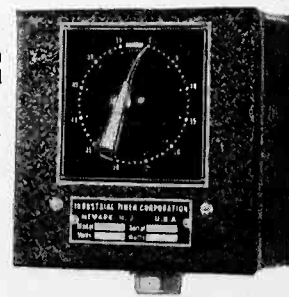

Units also furnished for flush or panel mounting

Manufacturers of timers for all purposes . . . send for catalogue

INDUSTRIAL TIMER CORP.

103 Edison Place
NEWARK, N. J.

effective ground point is taken as 5 feet. The curves are for two-way communication between a headquarters station and a mobile unit operating over a level territory in fairly open country. In hilly country or in business districts of cities these values will be reduced to approximately 60 per cent of those given.

Frequency modulation systems in the 30 to 40 Mc bands will have to use channel widths of 40 kc. Each station should occupy not more than 30 kc to leave a 10 kc guard band between stations on adjacent channels. Thus, the equipment is limited to a frequency swing of plus or minus 15 kc. This permits the audio range of the system to a frequency of 3,000 cps which covers the region of the frequency spectrum which provides maximum intelligibility of the human voice. Noise is further reduced by giving the transmitter a rising frequency characteristic so that there is a higher signal-to-noise ratio on the higher frequencies.

The equipment used in fm is more compact because the high power modulators are no longer necessary and operating costs are reduced because of the lower power input required for a given carrier output level. Also, all radio frequency stages can be rated Class C telegraph instead of Class C telephony. This means that the tube complement for a given power output will cost less and the maintenance costs will be lower.

Bank Vault Burglar Alarm Research

A REPORT GIVING THE RESULTS of extensive research into the sound present in burglary resistant vaults under normal and attack conditions is presented by H. D. Brailsford in the July 1940 *Bulletin of Research* of the Underwriters' Laboratories, Inc. The research was conducted to provide information for the most efficient use of burglar alarms making use of electronic sound systems. Such sound systems are designed to transfer sounds from inside the vault to some other point where action on the alarm may be made. The report gives information on the following points: 1. Ambient or normal sound levels of existing in vaults of various size, construction, location and occupancy. 2. Sound levels generated in vaults of varying size, construction and occupancy as the result of burglarious attack on the boundary walls. 3. Time duration characteristics of attack noises under various field conditions. 4. Frequency characteristics of attack noises generated in vaults under various field conditions.

In carrying out these investigations ambient noise levels were measured in more than fifty vaults during the course of regular field reexamination inspections under the Laboratories' Reexamination and Certificate Serv-

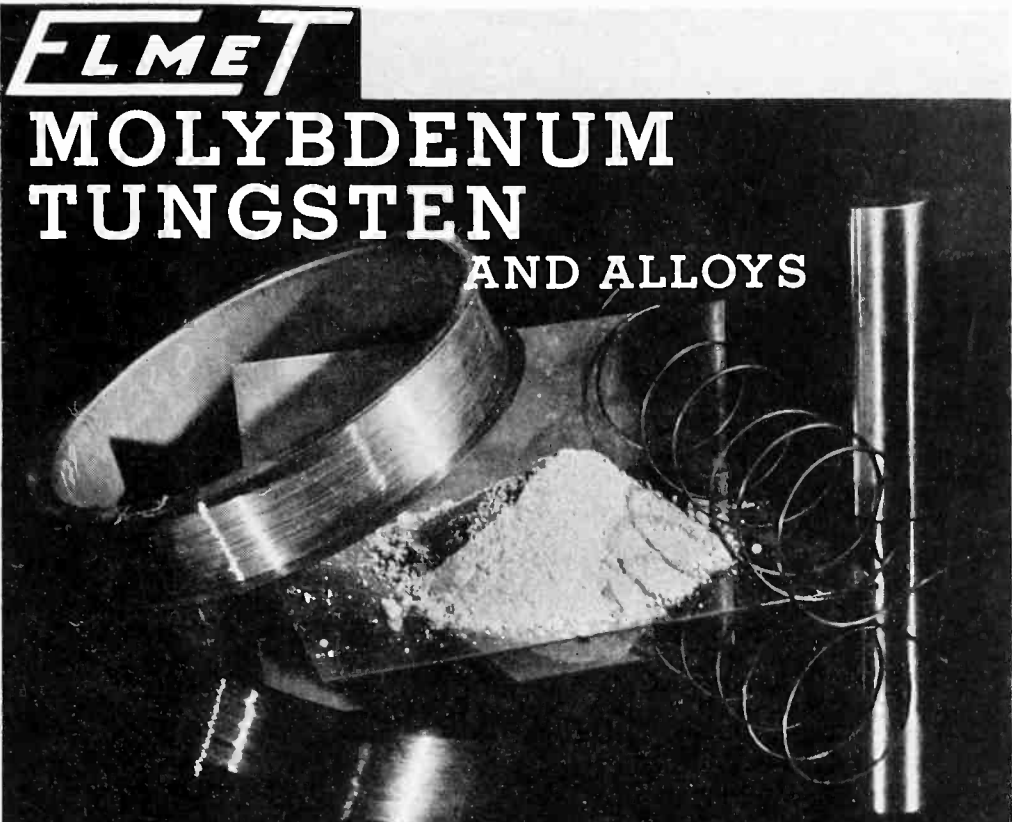

FLMET

MOLYBDENUM TUNGSTEN AND ALLOYS

FOR THE ELECTRONICS INDUSTRY

AMERICAN ELECTRO METAL CORPORATION

Research Laboratory and Offices: 320 YONKERS AVE., YONKERS, N. Y.
Factory: LEWISTON, MAINE

Cable Address: Cutanit Yonkers New York Telephone: Marble 7-9511

For Quality Reproduction Use

Oxford Speakers

Precision built to exacting specifications OXFORD Permag and Electro-dynamic speakers ranging in size from 2" to 14" will fill the bill no matter what the application.

Send us your specifications for prompt quotations or write Dept. E7 for further information.

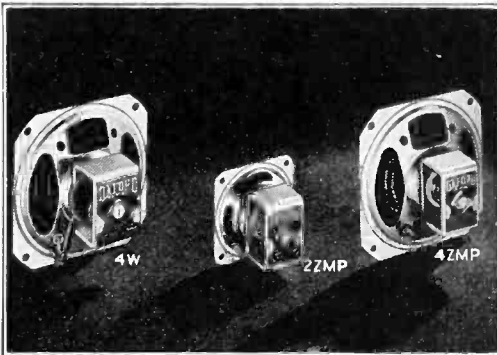

OXFORD-TARTAK

RADIO CORPORATION

915 W. VAN BUREN ST. • CHICAGO, U. S. A.



McGraw-Hill

DIRECT MAIL LISTS



As business paper publishers for over fifty years, McGraw-Hill is uniquely equipped to offer complete, authoritative direct mail coverage of Industry's major markets. Extreme accuracy is maintained (guaranteed to 98%) and through careful analysis of markets, complete classification of companies and personnel, etc., the widest possible selections are available. Send for handy reference folder, "Hundreds of Thousands of Reasons Why" which describes how McGraw-Hill Lists are built and maintained.

What Fields Do You Want to Reach?

- Aviation
- Bus & Electric Railways
- Civil Engineering and Construction
- Administrative Executives
- Electrical Dealers & Wholesalers
- Mill Supply Houses
- Power Services
- Product Engineering & Design
- Production and Maintenance
- Radio Dealers & Wholesalers
- Radio Engineering & Design

For further details, selections from above basic classifications, counts, prices, etc., or estimates on special lists . . . ask any representative or write to



DIRECT MAIL DIVISION . . .
McGraw-Hill Publishing Co.
330 W. 42nd STREET NEW YORK, N. Y.

Complete Lists Covering Industry's Major Markets

S.S. White **MOLDED RESISTORS**

The "All-Weather" Resistors

AMONG THE USERS

Radio Corporation of America
 RCA Manufacturing Co., Inc.
 RCA Communications, Inc.
 General Electric Co.
 Westinghouse Elec. & Mfg. Co.
 Automatic Electric Co., Ltd.
 Bartol Research Foundation,
 Franklin Institute
 R. S. Hart — Moisture Gauge
 Merck Institute of Therapeutic
 Research
 National Technical Laboratories
 Roller-Smith Company
 General Talking Pictures Corp.
 National Broadcasting Co.
 Pan American Airways, Inc.
 Railway & Industrial Engineering Co.
 U. S. Army and Navy
 Griffith Observatory
 Air-Track Manufacturing Corp.

These resistors have won favor because of their *noiseless operation and durability* and because they *retain their values and characteristics* under extremes of temperature, humidity and climatic changes. They're available in the following wide range.

STANDARD RANGE

1000 ohms to 10 megohms.

NOISE TESTED

At slight additional cost, resistors in the standard range are supplied noise tested to the following standard: "For the complete audio frequency range, resistors shall have less noise than corresponds to a change of resistance of 1 part in 1,000,000".

HIGH VALUES

15 megohms to 1,000,000 megohms.

SEND FOR BULLETIN 37

It shows pictures of the various types and gives all details. A copy, with price list, is yours on request.

S. S. WHITE

The S. S. White Dental Mfg. Co.
INDUSTRIAL DIVISION

Department R, 10 East 40th St., New York, N. Y.

ice. Measurements are presented of noise caused by attack on vaults of fifteen different types of physical construction. Phonograph records were made of noises produced by various types of attacks. This report will be especially interesting to two types of people, those concerned with the design of burglar alarms and those contemplating the burglary of a bank vault so that they may devise means of beating the alarm.

Erratum

In "A Light Regulator" by Britton Chance which appeared in the February 1940 issue of *Electronics*, the circuit diagram of Fig. 2 was incorrect.

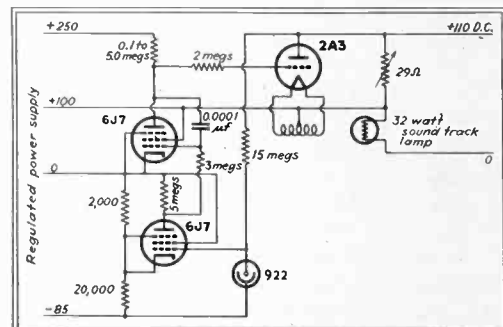

The correct diagram is given here. Also, the plate-to-grid condenser of the 6J7 tube shown in Fig. 3 should be 0.0001 μf.

• • •

RECEIVING STATION FOR METEOROLOGICAL DATA



The receiving station of one of England's Air Ministry meteorological radio-sonde installations. Signals from the small transmitter attached to a balloon are received and analyzed here. The receiver above the head of the left operator is an American product made in Chicago

NEW ECONOMY IN P-E DEVICES



Luxtron*

PHOTO ELECTRIC CELLS

BRADLEY LABORATORIES, INC.
 82 MEADOW ST. • NEW HAVEN, CONN.

*Reg. U.S. Pat. Off.

When Bradley Luxtron* Photo-Electric Cells are used, their high self-generated electrical output operates instruments or sensitive relays directly — without amplifiers or external voltage. That's why Luxtron* Cells, used extensively in commercial photo-metric and other measuring applications, are finding a wide new field in industrial control equipment. And the factors that make them pre-eminently satisfactory for measurement of infinitesimal variations in light values — stability, sensitivity, sturdiness, relative imperviousness to temperature changes — likewise suit them to industrial and laboratory applications.

The Bradley Laboratories will gladly cooperate with engineers on new developments, or in supplying standard or special cells for new applications.

Write today for complete technical data and descriptive catalog.

BRADLEY LABORATORIES, Inc.
 82 Meadow St., New Haven, Conn.

Please rush copy of Cat. No. 101.

NAME

ADDRESS

CITY STATE

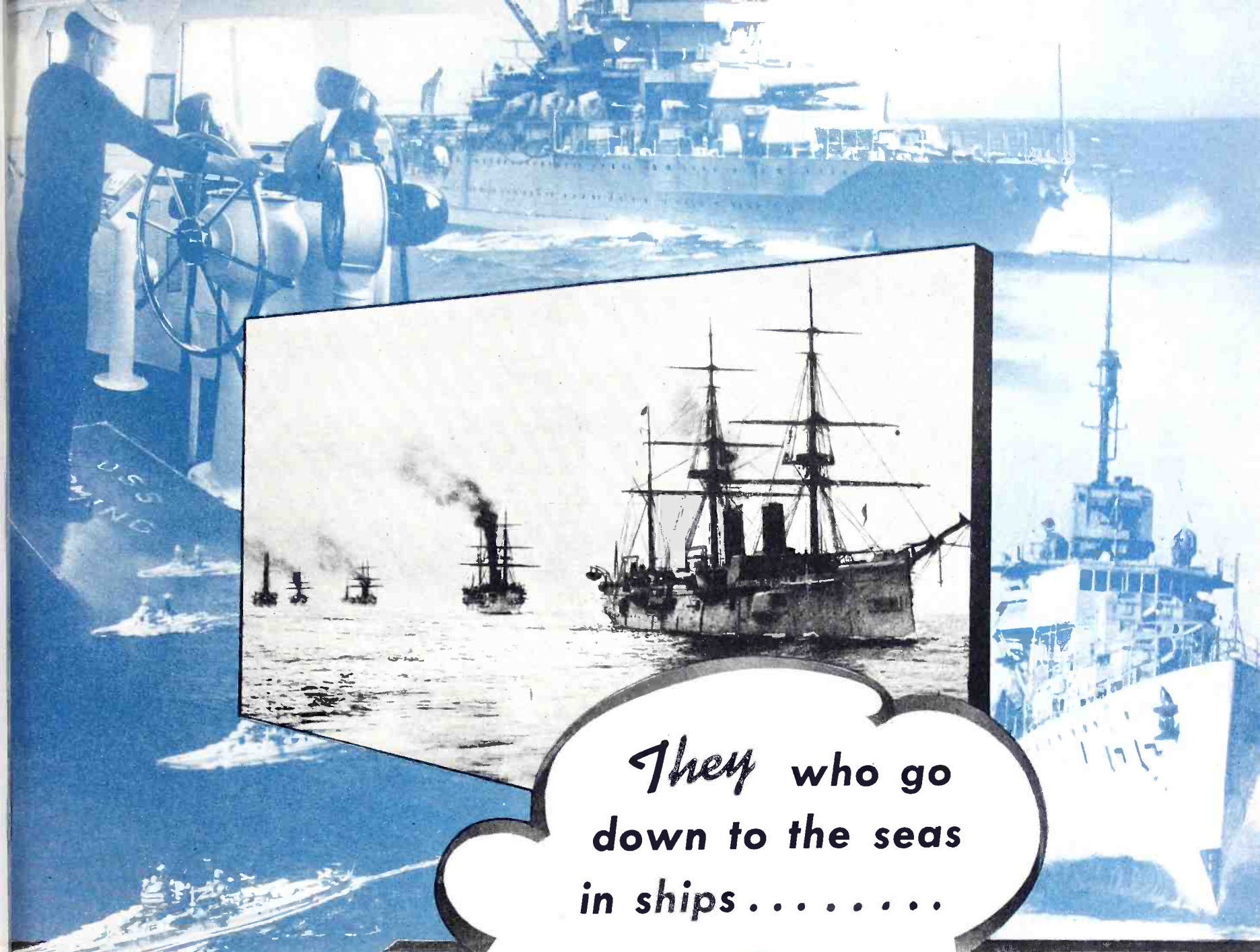

Official U. S. Navy Photos

They who go
down to the seas
in ships



TODAY — have developed an electronic Navy

● A new and greater Navy has been born since T. R.'s White Squadron cruised 'round the world. A vastly different Navy, too... with bigger ordnance, deadlier striking power, greater resistance, more adept maneuverability. Above all, the greatest advance has been in the improved mechanical efficiency and the effective coordination of every element within each fighting ship and between every unit of the battle fleet, its auxiliaries and bases.

Contributing in no small measure to this perfection of our Naval strength is the electron tube — basis for much of the development and progress in Naval construction and operation. Where and how the electron tube and its associated circuits are used by the U. S. Navy is to a great extent Government secret. But accepted uses by all modern Navies involve highly developed radio communication, direction finding, submarine signal and sound detection; centralized gunfire control, automatic steering

apparatus, heliographic signaling, and ranging.

In the shipyards, Naval Bases, at sea and in the air, — the Navy is using the latest developments of the electronic industry to provide our nation and the one remaining peaceful continent with adequate defense. The electronic industry has been working with and for the Department of the Navy in developing and producing these instruments of National Defense. As the program for a two-ocean Navy goes forward, greater demands will be made — quantity and quality production of electronic and allied goods, inventions and developments that will keep us ahead of the world in Naval proficiency. Fortunately, the electronic industry is prepared to meet any demand. Its willingness to cooperate with the Services is legend, and its manufacturing and operating facilities are at near peak for the industry's important part in the National Defense Program.

THE INDUSTRY IN REVIEW

News

♦ Mr. Orrin E. Dunlap, Jr., who for the past eighteen years has been the Radio Editor of *The New York Times* has been appointed Manager of the Department of Information of the Radio Corp. of America. Mr. Dunlap replaces Horton H. Heath, who has been appointed RCA Director of Advertising and Publicity . . . The U. S. Circuit Court of Appeals in St. Louis, Mo., recently ruled that the word "Pyrex" is not public property but a trade-mark of Corning Glass Works . . . Shure Bros., manufacturers of microphones and acoustic devices, announce the appointment of Ben B. Bauer as Shure engineer. Mr. Bauer is responsible for the development of the Uniphase principle used in "Uniphase" and "Unidyne" cardioid microphones . . . Professor Noble of the University of Connecticut, an outstanding figure in the development of frequency modulation, has resigned his position to accept the directorship of Research & Advanced Development for Motorola Radio, it was announced by Galvin Mfg. Corp., of Chicago . . . Col. Louis Blaine Bender, has retired from the Signal Corps, U. S. Army, after 31 years of service, to become Consulting Engineer of the Radio Division, Westinghouse Elec. & Mfg. Co., in Baltimore, Md. . . . Doolittle & Falknor, Inc., of Chicago, Ill., is now known as Doolittle Radio, Inc. It is the same company, with the same personnel and none of the stock has changed hands . . . F.C.C. approved applications by C.B.S. for permits to build two new 50,000-watt short-wave stations on Long Island. A 50,000-watt station will be installed at Brentwood, N. J., and CBS's present short-wave station, WCBX will be removed from Wayne, N. J. . . . Television will make its bow in Cincinnati and vicinity when the Crosley Corp., operator of WLW, starts work on a station authorized by F.C.C. in a decision announced recently. The construction permit stipulates that the new station will operate on television channel number one (50,000 to 56,000 kc) with visual and aural power of 1 kw . . . The RCA Mfg. Co., has completed plans for enlarging its plant at Indianapolis, Ind., by the addition of one building unit of 100,000 sq ft of space, the first of a total of some 400,000 sq ft which the Company will need to meet requirements under the National Defense Program for products now manufactured at Indianapolis . . . The Callite Tungsten Corporation has added approximately 100,000 square feet of floor space to its facilities through the acquisition of a large factory property neighboring its main plant at Union City, New

Jersey. This step has been made necessary by the general expansion of the Callite business and by the transfer to Union City of the production of round, flat and shaped wire of standard and special alloys of the recently acquired Harris Alloys, Inc. . . . The Webster Co., Chicago, manufacturers of sound equipment, record changers, etc., announces the adoption of Webster-Chicago Corp., as their new corporate title . . . Ten of Indianapolis Power & Light Company's service cars and trucks are being equipped with G-E 25-watt f-m mobile transmitters and receivers for two-way communication . . . The Kahl Engineering Corp. of North Bergen, N. J. has just completed and installed the largest automatic machine for the production of new fluorescent lamps. The machine was placed in operation in one of the plants of the General Electric Co. . . . The British Government has taken over an order previously placed by the French for the manufacture of Finch duplex facsimile units to be used as a military aid in the battle of England. Because the machines can transmit by radio, maps, charts, and written orders, etc., they have been found of special value to the air corps . . . Harry J. Kayner, recently of Belmont Radio Corp., has been appointed Assistant Chief Engineer at Doolittle Radio Inc. . . . Complete radio equipment for six river towboats and one ground station to be located at Cape Girardeau under a recently authorized grant by F.C.C. has been contracted by Erlbacher Brothers, Cape Girardeau, Mo.

with Gates American Corp. This is the first installation of this kind to be made on the Mississippi River. Each towboat transmitter has 100 watts power with provision for five-frequency operation and boats are equipped with especially designed crystal control five-frequency receivers. The ground station is voice controlled and connected with the standard telephone service for probable service . . . Other construction awards as follows: Air Corps award for vibrator inverters at a cost of \$50,500 to Electronic Laboratories, Inc., Indianapolis, Ind. Signal Corps awards are: For radio transmitting equipment, \$5,297,775, to General Electric Co., Schenectady; Radio components, \$112,161.13, Federal Telegraph, Newark, N. J.; Radio transmitting equipment, \$452,222.50, G. E. Co., Schenectady, N. Y.; Radio compasses, \$673,906.50, Bendix Radio Corp., Baltimore, Md.; Radio transmitting equipment, \$454,415.00, The Rauland Corp., Chicago, Ill.; Radio transmitting equipment, \$543,753.50, Federal Telegraph, Newark, N. J.

Literature

Short Wave Station Guide. A new 16-page short-wave station guide which lists several hundred stations throughout the world, together with their frequencies and call letters, has been prepared by the broadcasting division of the General Electric Co., Schenectady, N. Y.

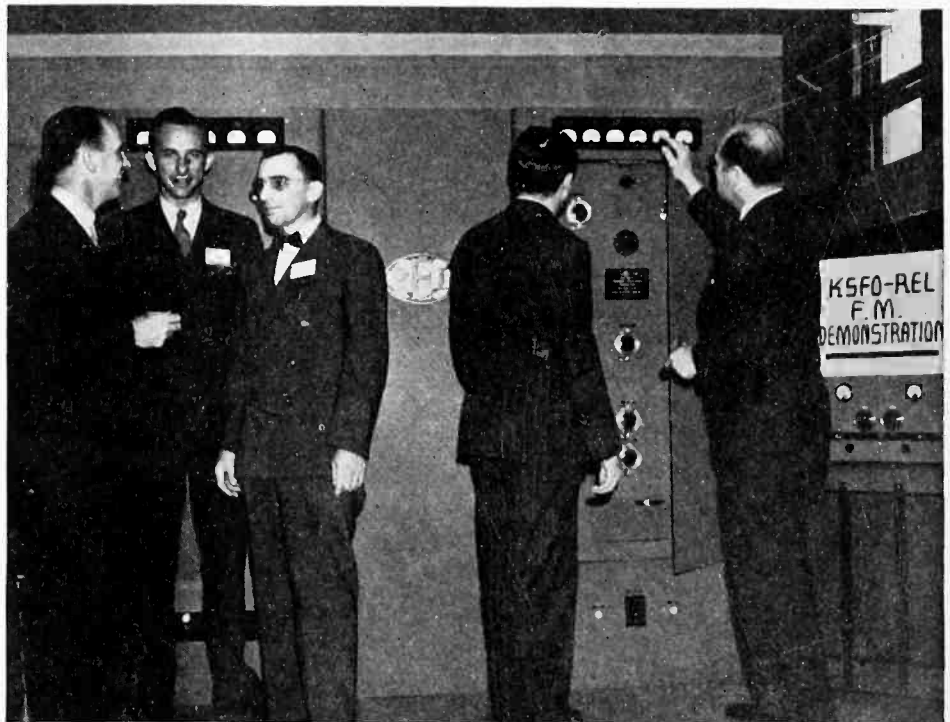

At the F-M transmitter set up for the NAB Convention in San Francisco, R. V. Howard of KSFO, Frank Gunther of R. E. L., Paul DeMars of the Yankee network, Clifton Howell of KSFO and Gustavus Reiniger of R. E. L.

Super-Sensitive "MULTI-PURPOSE" TEST EQUIPMENT



Series 854 Super-Sensitive Tester

Especially designed to meet the exacting requirements of Laboratory, Industrial, Television and Radio.

20,000 OHMS PER VOLT D.C.

1,000 OHMS PER VOLT A.C.

- SEVEN D.C. and SEVEN A.C. voltage ranges to 6,000 VOLTS • SEVEN D.C. current ranges 0-60 MICROAMPS to 0-12 AMPS
- THREE resistance ranges to 60 MEGS (self-contained batteries) • SIX D.B. ranges from -12 to +70 DB • SEVEN output ranges to 6,000 VOLTS • 4 1/2" wide-faced, 50 micro-ampere meter • 1% wire-wound bobbins and matched metallized multipliers. 2% D.C. and 3% A.C. overall accuracy.

SERIES 854P (Illustrated) complete with batteries and high voltage test leads. Net Price **\$39.95**

Series 854J Super-Sensitive Industrial Circuit Tester

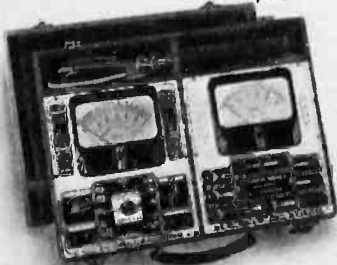

An unsurpassed portable instrument to satisfy industrial requirements for complete AC and DC circuit analysis. Combines Series 854 (described above) and Series J A.C. AMMETER providing 8 additional ranges of 0-300-600-1200 MA and 0-3-6-12-30-60 AMPS.

Series 854J (Illustrated) complete with batteries and high voltage test leads. Net Price **\$59.95**



Series 954 Super-Sensitive AC-DC Set Tester and Dynamic Mutual Conductance Type Tube Tester

Provides all facilities of Series 854 combined with a complete free-point tube tester.

Series 954P (Illustrated) complete with battery and high voltage test leads. Net Price **\$65.95**

Write for the new "PRECISION" 1941 Catalog describing more than 40 test equipment models.

PRECISION TEST EQUIPMENT
Standard of Accuracy SEE THEM AT YOUR JOBBER

PRECISION APPARATUS COMPANY
647 Kent Avenue Brooklyn, New York
Export Div.: 458 Broadway, New York, U. S. A.
Cables: Morhanex

Cathode-Ray Stopwatch An issue of *Oscillographer* describes a method whereby a conventional cathode-ray oscillograph is employed as an indicator for determining the transit-time of electrical switching equipment such as relays and contactors. A graphical solution of the pattern obtained from the cathode-ray oscillograph is presented, examples of the method are given, and its extension to other problems is discussed. The *Oscillographer* is published by Allen B. Dumont Laboratories, Inc., Passaic, N. J.

Testing Bulletins. Two bulletins are available from Solar Mfg. Corp., Bayonne, N. J. One bulletin, tells about capacitor Exam-eter Model CE which combines in one instrument all the testing features of other condensers developed by Solar. The other bulletin, No. AC, contains a listing (by manufacturer and part number) which is intended to aid in identifying the correct replacement capacitor for use with nearly all known electrolytic capacitor starting motors.

Test Kit. An instrumental test kit (this includes ammeter, voltmeter and transformer and weighs 10 lbs.) is illustrated and described in a folder available from Herman H. Sticht & Co., 27 Park Place, New York City.

Vacuum Tube Voltmeters. The vacuum tube voltmeter and its use in radio servicing is the subject treated in Supplement No. 10 to the 3rd edition of Mallory-Yaxley Radio Service Encyclopedia available from P. R. Mallory & Co., Indianapolis, Ind. This data was compiled with the cooperation of Clough-Brengle Co., General Radio, Hickok Electrical Instruments, Meissner Mfg., RCA Mfg., and Triplett Electrical Instrument Co.

General Radio Catalog. A 1940-41 catalog illustrates, describes and lists standard parts normally carried in stock by James Millen Mfg. Co., Inc., 150 Exchange St., Malden, Mass. It is intended primarily for the amateur and experimenter. Some of the items included are condensers, dials, drives, coils, forms, shields, chokes, antenna devices, safety terminals, connectors, i-f transformers, etc. Other data are available on request on component parts and complete transmitters, receivers, amplifiers, control units, etc., for the different government departments and for commercial communication equipment manufacturers.

Airport Traffic Control Transmitters. Bulletin No. 5002 describes rather completely Series 427-428 u-h-f airport traffic control and communications transmitters available from Radio Receptor Co., Inc., 251 West 19th St., New York City. These transmitters have been produced as a result of a transmitter developed by Radio Receptor Co., for the Civil Aeronautics Authority.

PINCOR PRODUCTS FOR AIRCRAFT SOUND and other POWER SUPPLY USES

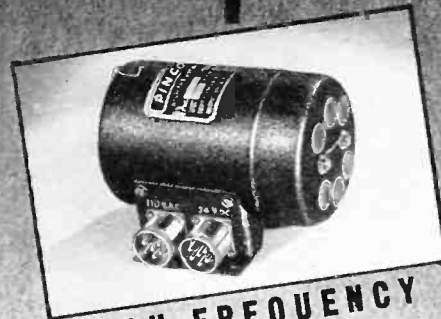

HIGH FREQUENCY CONVERTERS

Pincor High Frequency Converters are precision built for smooth, silent, dependable performance. 5 to 500 watts. 400 and 500 cycles. Special units designed to meet any output or requirements.



SMALL MOTORS—A.C. and D.C.

These small motors are particularly adapted for band switching, remote control, etc., for aircraft use or wherever a small light weight motor is required for unfailing service. 20 watts output. Others as required.



DYNAMOTORS

Pincor Dynamotors afford a dependable "B" power supply for aircraft, marine and broadcast service, mobile units, etc. Highest efficiency and regulation. 5 to 850 watts. Input 6 to 110 volts; output up to 1750 volts.

Write or Wire for Information
PIONEER GEN-E-MOTOR CORPORATION
Dept. R-4, 466 West Superior St., Chicago, Ill.
Export Address: 25 Warren St., N. Y., N. Y.
Cables: Simontrice, New York

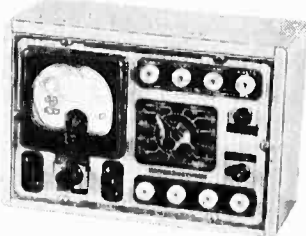

RCP SUPERTESTER MODEL 411

If service is what you look for in test equipment, next of course to quality, this instrument deserves your investigation. A Supertester, RCP Model 411 gives you what is probably the maximum number of useful measurements in one instrument for motors, plants, labs, substation, electric light circuit work—even television! Quality-built for years of trouble-free performance.

This is the most comprehensive compact tester ever devised. It provides accurate measurements in ranges never before available in small instruments. 5 AC and 5 DC ranges 0/10/100/250/1000/5000 volts. Six AC and DC ampere ranges to 25 amps. 4 ohmmeter ranges reading from 0.1 ohm to 4 megohms. DC milliamps 0/10/100. DC microamps from 0-200. AC milliamps 0-300. It's 33 individual instruments in one! Natural finish hardwood case 7⁷/₈" x 5¹/₂" x 3¹/₂". Net **\$16.25**

RCP SIGNAL GENERATOR MODEL 702

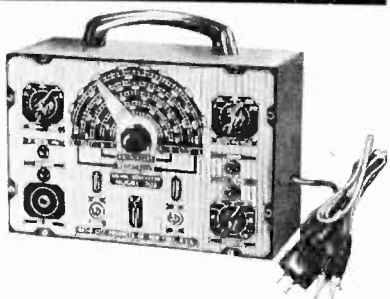

Capable of even finer performance than RCP's famous former signal generator. Has all latest improvements in circuit and mechanical design. Extremely wide all-wave coverage continuously variable from 95 Kilocycles to 100 Megacycles. Output modulated at will. 30% modulation at 400 cycles, sine wave, from self-contained, independent 400 cycle circuit. Attenuation in approximate microvolt calibration by means of five step ladder attenuator. Highly attractive appearance. 8¹/₂" x 11³/₄" x 25" Net **\$22.95**

CATALOG describing in detail these and other instruments in RCP's complete line of dependable test equipment free on request. Write today.

RADIO CITY PRODUCTS CO., INC.
88 PARK PLACE • NEW YORK, N. Y.

RCP
dependable
TEST
instruments

Relays. A 4-page folder available from Allied Control Co., 227 Fulton St., New York City, describes and illustrates such relay types as PC for photoelectric devices, radio receivers and transmitters, intercommunication equip., etc.; Type D for use in antenna transfer, filament control, etc.; Type J designed especially for applications where small space and resistance to vibrations are important requirements; Circle sensitive relays which were described last month; High frequency relays; Band switch relays; etc.

New Products

Microdyne

AUDAK CO., 500 FIFTH AVENUE, New York City, have available "Relayed-Flux" Microdyne reproducers for every purpose. Some of the characteristics of this equipment are: Flat within $\pm 1\frac{1}{2}$ db to 10,000 cps; low vibratory momentum; absence of distortion; free-floating stylus; designed for and equipped with jewel point; point-pressure about 18 grams; and immune to climatic changes. An extremely small moving mass is achieved by having the conventional armature stationary and relaying the magnetic flux to it through a tiny moving mass. Literature is available from Audak.

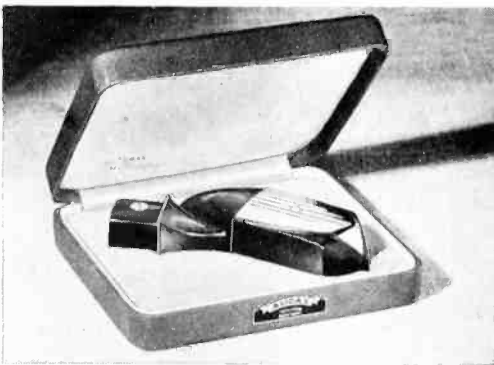

Microdyne Model Pro-5 has an output of -35 db, will track at 15 grams pressure. A somewhat less expensive model, type Pro-3, requires about 1 $\frac{1}{2}$ ounce pressure and has an output of -30 db.

Color Coded Condensers

ALL MALLORY TUBULAR PAPER CONDENSERS—Types TP (wax-impregnated, ax-filled), OW (oil-impregnated, wax-filled) and OT (oil-impregnated, oil-filled) now bear a brilliantly colored label which gives better visibility to capacities and instantaneous recognition of voltages by means of a bottom band of color properly coded to RMA specifications. The color-code band goes completely around the condenser so that it may be readily seen and the voltage identified no matter how the condenser is placed in the set. Construction remains unchanged; the labels are merely applied over the customary cardboard tube and wax coating.

New Carter AIRCRAFT TYPE GENEMOTORS



• Here is a new complete line of Genemotors for Aircraft, Police, Marine Radio, and general use, where dependable and efficient service is required. Armatures are wound with double enamel and silk wire, insuring trouble free operation. There is a Carter Genemotor or Converter for every requirement from 5 to 1000 watts output. Write for further information.

Carter Motor Co.
CHICAGO ILLINOIS

1606 Milwaukee Ave. Cable: Genemotor
Carter a well known name in Radio since 1922



AN ORGANIZATION that can assist TRANSFORMER BUYERS

Acme's experience in building transformers for neon, radio, lighting and other voltage control and regulation applications is a valuable asset which you can use to better the performance of your product. Consult with an Acme Electric Transformer Engineer, and let him help you develop a better transformer for your needs and perhaps at a price that may show you exceptional economies. Acme specializes in volume production of specially designed transformers. Your inquiry invited.

THE ACME ELECTRIC & MFG. CO.
31 WATER STREET • CUBA, N. Y.

Acme ACME Electric
TRANSFORMERS



**STRAIGHT
to the MARK**

Next time you buy relays or timers try Dunco! Let us prove the advantages of Dunco quality plus Dunco service in fitting units to your specific requirements. Don't guess on anything so important to the performance of your product. Get the facts! See how Dunco service speeds straight to the mark in assuring the utmost in electrical control dependability, plus honest economy of a type that is readily evident in the long run.

DUNCO RELAY BOOK gladly sent on request. Invaluable to relay users.

STRUTHERS DUNN, Inc.
1326 Cherry Street
Philadelphia, Penna.

DUNCO RELAYS
Made right - Priced right - Adapted to your needs



**"Mangrid"
GRID WIRE**

*Economy
with quality*

**"Mangrid"
made only by**

WILBUR B. DRIVER CO.
NEWARK, NEW JERSEY

Q-Meter

TYPE 160-A Q-METER, available from Boonton Radio Corp., Boonton, N. J., represents a marked improvement in the performance of its predecessor, the type 100-A Q-meter. The most significant improvements which have been made are the increase in frequency coverage (frequency range is 50 kc to 75 Mc and 1 kc to 50 kc with external oscillator) and greater accuracy (which is achieved by new additions built into the instrument). The Q

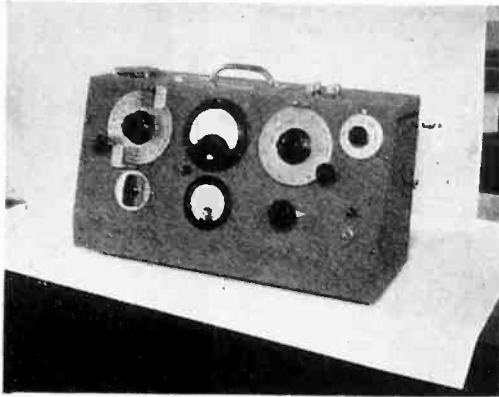

voltmeter is calibrated directly in Q, 0-250. For calibration in volts, a specially calibrated tube, type BRC 101-A, is used. Replacements may be made without recalibration. The instrument can be operated on 100-120 volts, 50-60 cps, and is also available for operation on 200-240 volts, 50-60 cps, and on special voltages and frequencies upon request. Power consumption is 50 watts.

Crystal Unit

A NEW 1000-KC CRYSTAL UNIT, Type G18A, for use in amateur frequency standards has been announced by General Electric, Schenectady, N. Y. It has a temperature range of +10 degrees to +45 degrees centigrade and a temperature coefficient over that range of .0001 per cent per degree C. Employing the same hermetically sealed, metal-tube type construction as that which houses G-E crystal units for broadcast stations, the unit is immune to atmospheric effects such as dust, moisture, etc. When used in recommended circuits, the G18A can be installed as shipped from the factory and adjusted to zero beat against standard transmissions such as those from WWV, standards station at Washington, by means of a small capacitor shunted across the crystal.

R-F Transmitting Switch

A NEW R-F TRANSMITTING SWITCH, Type 88, available from Communication Products Co., 245 Custer Ave., Jersey City, N. J. has the following specifications: single pole; maximum number of positions, 9; a maximum of 5 sections may be ganged; continuously rotatable or with stops furnished for any positions desired; standard spacing between sections, 1-1/16 inches.

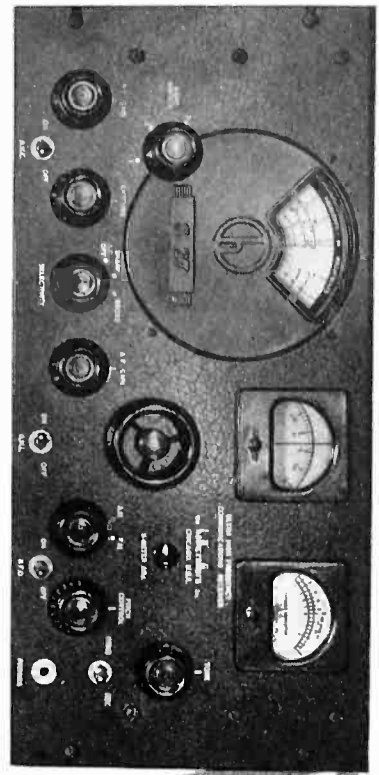

Sold in 89 Countries
Used by 33 Governments
CHICAGO, U. S. A.

the Hallicrafters Inc.

The new Model SX-28 (right) is a 15 Tube general purpose communication receiver incorporating the latest technical advances. Each sells for less than two hundred dollars.

Efficiency!
IN TWO NEW HALLCRAFTERS RECEIVERS
Both designed to government specifications, Model S-27 (left) is the first general coverage UHF receiver providing reception of both Amplitude and Frequency modulated signals. (27 to 145 Megacycle coverage).

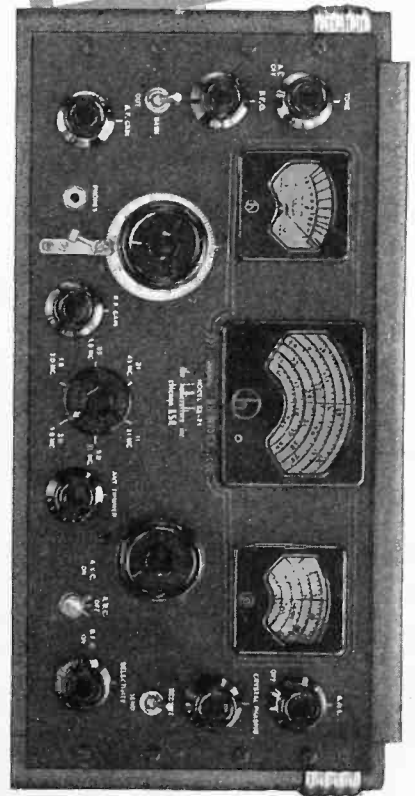



A New Method of Protecting Insulated Wires

Seamless ALUMINUM, COPPER or BRASS Tubing is drawn over the wire or wires in such a manner that any kind of a bend can be made and the ends easily trimmed.

CHECK THESE ADVANTAGES

- (1) The seamless metal shield gives positive protection to the wire against Corrosion, Abrasion, Acids, Oils, Alkalies, Solvents etc.
- (2) It is compact, light in weight and neat in appearance.
- (3) Tubes made in any required wall thickness.
- (4) Outside diameter of the tube can be held to close tolerances.
- (5) Practically any number of wires can be shielded by this method.
- (6) Armor like protection gives added stiffness, yet easily bent.
- (7) Furnished in exact lengths, multiple lengths or random lengths.
- (8) Has satisfactorily withstood the severest kind of tests.

SEND FOR FREE SAMPLES

We invite your inquiries and will gladly forward an assortment of samples for your inspection. . . .

See what a practical product PRECISION'S Shielding is. See how easily the leads can be trimmed; try out its bending qualities and ease of installation.



PRECISION TUBE CO.

Specialists in accurately drawn Seamless ALUMINUM, COPPER and BRASS Tubing, in the smaller sizes.

200 OSBORN ST. PHILADELPHIA, PA.

Please send samples of your METAL SHIELDED WIRE to

Name

Firm

Address

Adjustable Dynamic Microphone

MANY DESIRABLE CHARACTERISTICS HAVE BEEN incorporated in a new microphone, Model VR2, available from American Microphone Co., Inc., 1915 S. Western Ave., Los Angeles, Cal. This microphone is licensed by Electrical Research Products, Inc., under U. S. Patents of A.T.&T. Co., and Western Elec. Co., Inc., for use only in PA systems. The VR2 has an easily accessible external adjustment of the



most important acoustical reactors in the dynamic microphone. A smooth change from a communication-type response, with a cutoff below 500 cps, through a flat response to an augmented bass, attained by a simple, positive adjustment. The response adjustment on the VR2 has a very broad effect and does not introduce narrow peaks. It comes complete with removable baffle and 12½ inch cable and plug at microphone providing balanced line.

Photo-Relay Units

ALLIED CONTROL Co., 227 FULTON ST., NEW YORK CITY, have available several photo relay units which are easily mounted and adjustable as to sensitivity. Standard sockets are used. Type No. PR-1 is a photo-amplifier relay unit for use where relatively large amounts of light are available. It operates on both a-c and d-c currents. Type No. PR-2 is a sensitive photo-amplifier relay unit for use where reliable operation with relatively small amounts of light is desired. Type No. PR-3 is for applications where it is either impossible or undesirable to use a separate light source. It is similar to type PR-2 except the light source is contained in the same unit and it requires the use of a mirror. Both types PR-2 and PR-3 are for ac only. Type PR-4 is a small independent light source operating on the a-c or d-c line and will throw a concentrated beam up to 50 feet.

Distortion Set

THE HEWLETT-PACKARD Co. (481 Page Mill Rd., Palo Alto, Cal.) has just released their 320A distortion measuring set. This unit was designed to meet the demand for a reasonably priced item to allow radio stations, laboratories, public address operators and maintenance men to make distortion measurements quickly and easily. The 320A may be used with any signal generator and oscilloscope to give distortion readings at two different frequencies.

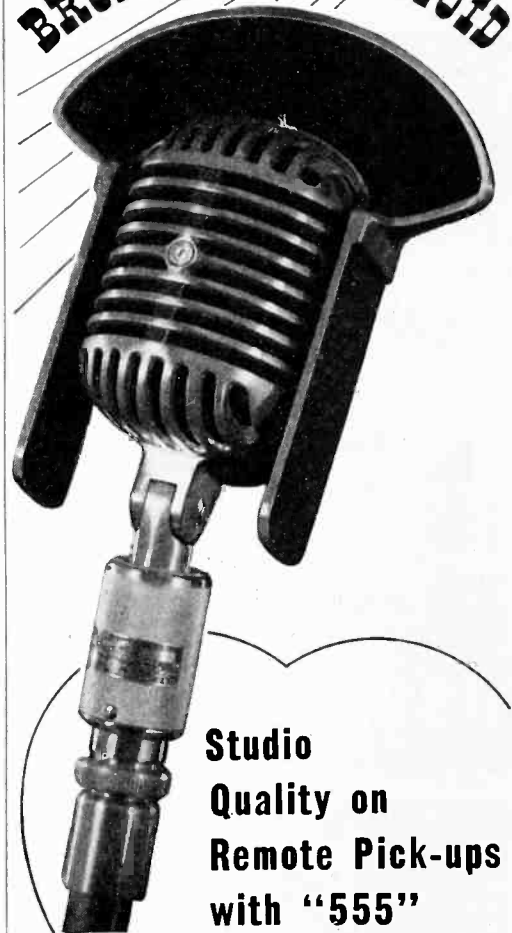

Studio Quality on Remote Pick-ups with "555" Dynamic

Meets the strictest requirements for a high quality studio microphone. Also your answer to troublesome sound pick-up problems on remote. The "555" Cardioid Dynamic is dead at rear. Reduces reflection and reverberation effects—solves background noise. Extremely rugged—uses only one unit instead of two—made possible by the exclusive Shure "Uniphase" principle. This also means uniformity and lower production cost. That's why station after station is going "555." Available in 35-50 and 200-250 ohm models, also high impedance. List Price (subject to usual trade discount).....\$60.

30 Days Free Trial to broadcast stations and recording studios. No obligation. Send for it now—or write for Bulletin 165M.

Shure Patents Allowed.



SHURE BROTHERS
225 W. Huron St., Chicago, U. S. A.

Four Range Rheostat

A NEW TUBULAR SLIDE-CONTACT RHEOSTAT for laboratory use is available from Rex Rheostat Co., 37 West 20th St., New York City. These "Four-Range" rheostats incorporate 4 different ohmic values with 4 current capacities, and therefore take the place of 4 different rheostats. This rheostat

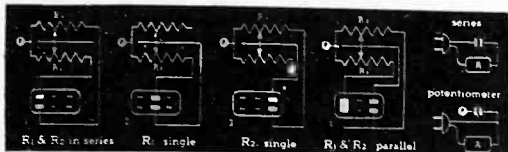

is easy and quick to manipulate and to apply to any particular regulating purpose of current and voltage. It has 2 turn-to-turn wound windings which are operated by one slider. The windings of the 2 wires are of identical diameter, but of different material, such as a nickel-copper and a chrome-nickel alloy so that the ohmic value of the windings is different. The re-

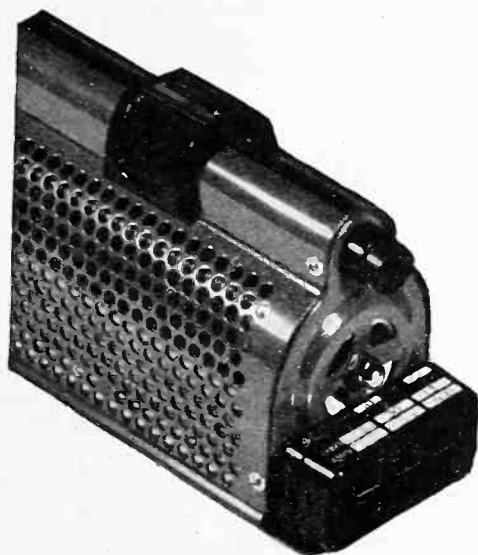

sistance material is insulated with fiber-glas to assist in retaining satisfactory dielectric strength at the temperature reached when the rheostat is fully loaded. These rheostats are available in two sizes. Model 1 of 350 watts capacity, tube diameter 1.75 ins x 16 ins in length. Model 2, of 650 watts capacity, tube diameter 2.5 ins x 20 ins in length.

Air-Cooled Transformers

AN ADVANCED DESIGN OF AIR COOLED TRANSFORMERS providing a higher factor of operating safety has been announced by the Westinghouse Elec. & Mfg. Co., E. Pittsburgh, Pa. With 60 cps ratings ranging from 150 to 500 kva inclusive for single phase and 150 to 1000 kva inclusive for 3 phase, voltages of 13,200 volts and below, type ASL transformers are designed specifically for installations in buildings where safety is essential. Because no fire and explosion hazards are possible with this design, substantial savings are obtained by the elimination of protective vaults. Improved regulation and increased output are obtained.

LEADERSHIP!

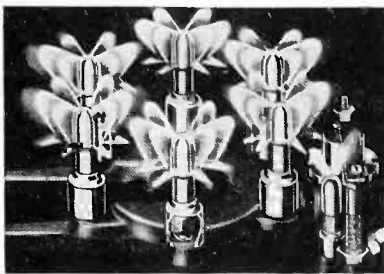

CRANE Keystone and Champion Gas Water Heaters rely on WILCO

A safety gas control is an essential part of a CRANE Gas Water Heater. For lasting service and safety, it must be dependable.

And that's why the manufacturer of CRANE Keystone and Champion Gas Water Heaters has standardized on Wilco Thermometal. Because, like so many hundreds of other leaders, Bastian-Morely Co., Inc., realizes there is no sub-

stitute for Wilco dependability, accuracy and sensitivity.

Pioneers in the development of thermometals as well as of electrical contacts, Wilco's experienced research staff stands ready to aid in whatever temperature control problem you may have. For a quicker, more economical solution write for "Wilco Blue Book of Thermometals and Electrical Contact Materials."

The H. A. Wilson Co., 105 Chestnut St., Newark, N. J. Branches: Detroit and Chicago

WILCO THERMOMETAL

(Thermostatic Bi-Metal)

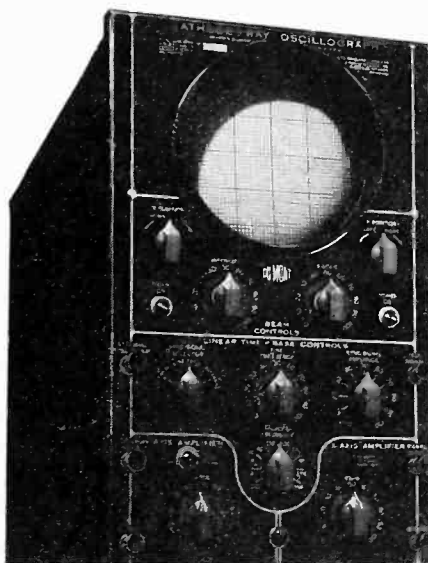

POSITION CONTROL

exasperating thing which it usually is, to an amplifier whose convenience of control can be judged accurately by its high-frequency rating alone.

With this and other desirable features—truly a decade's worth of outstanding engineering achievements—the DuMont 208 is by far the best money value among laboratory oscillographs. ★ Write for Form 48 describing this instrument.

★ To the man who has worked with amplifiers having good low-frequency response, the convenience of the *instantaneous position control* available in the DuMont Type 208 Cathode-Ray Oscillograph, will very likely mean "all the difference in the world".

The addition of the direct-coupled deflection circuit, making such position-control possible, changes a good low-frequency oscillograph amplifier from the slow, sluggish,

DU MONT

ALLEN B. DU MONT
LABORATORIES, Inc.

Passaic ★ New Jersey

Cable Address: Wespexlin, New York

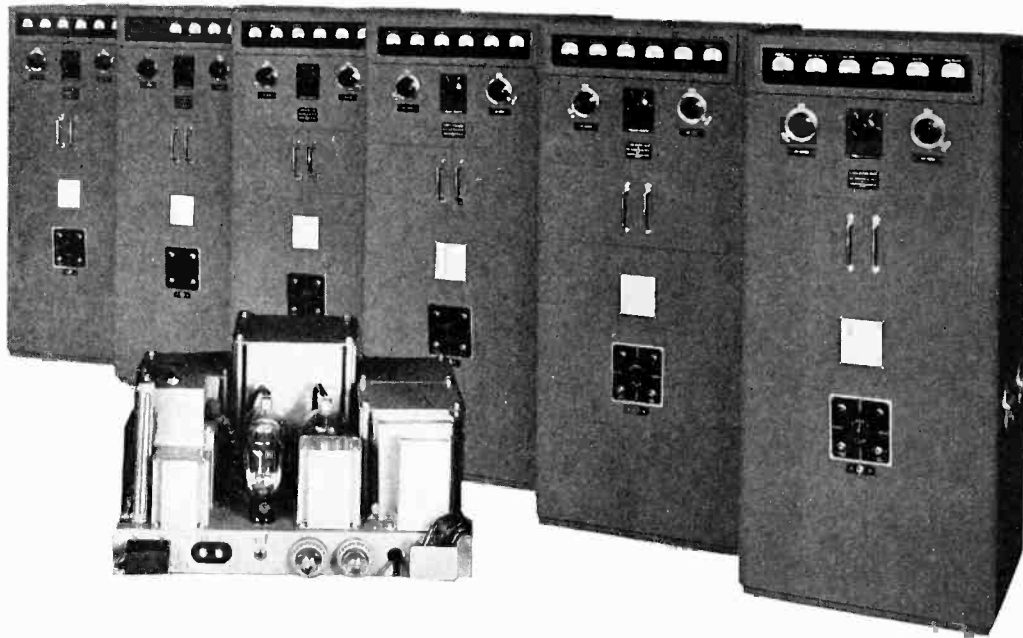

FOR THE NATIONAL GUARD!

Just recently, Transmitter Equipment Manufacturing Co., of New York, completed this group of Temco 150 watt, 4-band, radio telephone and telegraph transmitters for the Illinois National Guard.

Because the first consideration in the building of these units was dependability, it was only logical that KENYON TRANSFORMERS were specified just as they have been by so many other manufacturers who must deliver *plus* value in their equipment.

If it's a prestige product, more than likely it's a Kenyonized Product. There must be a reason for such preference!

Our engineering Department will be glad to give you the facts which will convince you of the desirability of Kenyonizing your equipment!

KENYON TRANSFORMER CO., Inc.
840 BARRY ST. NEW YORK, N. Y.

UNBRAKO
Reg. U.S. Pat. Office
SCREW PRODUCTS

STANDARD PRESSED STEEL CO.
Box 596, JENKINTOWN, PENNA.

IF you're careful about the selection of screws for electrical service, you'll compare. And having compared you'll choose "Unbrako" Products for their uniformity and strength; for their unique self-locking feature; for their knurled heads with a non-slip grip that saves assembling time. Complete range of sizes from number 4 up. Write for samples and literature.

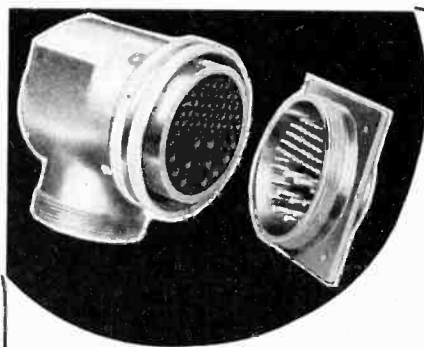

SKILL & EXPERIENCE

A compact, skilled organization... developed through a quarter century of manufacturing... personalized service for every client... the widest variety of fittings... these factors have won for CANNON Multiple-Contact Electrical Cable Connectors recognized leadership in a world market. CANNON Plugs are pre-eminent in the fields of Sound, Aeronautics, Geophysical Research, Instrument-Control on Ships and Laboratory Panels.

Illustrated Bulletins afford valuable information on Plug Problems. Bulletin "P & Q" devoted exclusively to Sound. Please specify your requirements when requesting Bulletins.

CANNON ELECTRIC DEVELOPMENT CO.

420 West Avenue 33, Los Angeles, California
Eastern Sales Office: 220 Fifth Ave., New York, N. Y.



CANNON PLUGS

Miniature Motor

THE NEW MODEL K SHADED POLE INDUCTION MOTOR, recently developed by Alliance Mfg. Co., Alliance, Ohio, is designed to deliver about four times the power output of their Model MS. A maximum continuous duty hp rating of 1/100 is obtained. A two pole design is employed providing no-load rotor speeds of approximately 3450 rpm. Starting torques range upwards to 2½ in-oz consistent with continuous duty rating with free air circulation. Maximum running torques are 1½ higher than starting torques.

Power Level Recorder

AT A PRICE WHICH ALMOST ANY LABORATORY can afford, Sound Apparatus Co., (150 West 46th St., New York City), offers a new small power level recorder of good quality. The instrument can be equipped with a db potentiometer in

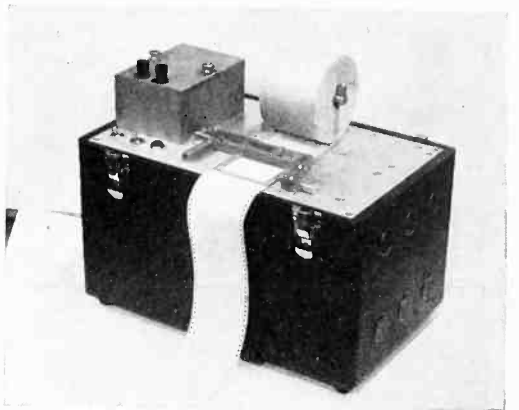

steps of ¼, ½, ¾, and 1 db. Available, also with linear potentiometer or phon potentiometer for making loudness measurements. The instrument is built for 110 volts, 60 cps. Physical dimensions are 10½x12x8 in., and the weight is 22 pounds.



Meade Brunet, well known figure in the radio industry for twenty years, has been appointed Manager of the R C A Manufacturing Co. Engineering Products Division in addition to his position as Manager of the Company's Washington office

Note

The Library comprises a selection of books culled from leading McGraw-Hill publications in the radio field.



McGraw-Hill RADIO ENGINEERING LIBRARY

—especially selected by radio specialists of McGraw-Hill publications

—to give most complete, dependable coverage of facts needed by all whose fields are grounded on radio fundamentals.

—available at a special price and terms

These books cover circuit phenomena, tube theory, networks, measurements, and other subjects—give specialized treatment of all fields of practical design and application. They are books of recognized position in the literature—books you will refer to and be referred to often. If you are a researcher or experimenter—if your interest in radio is deep-set and based on a real desire to go further in this field—you want these books for the help they give in hundreds of problems throughout the whole field of radio engineering.

5 volumes 3319 pages, 2298 illustrations

1. Eastman's FUNDAMENTALS OF VACUUM TUBES
2. Terman's RADIO ENGINEERING
3. Everitt's COMMUNICATION ENGINEERING
4. Hund's HIGH-FREQUENCY MEASUREMENTS
5. Henney's RADIO ENGINEERING HANDBOOK

Special Low Price and Easy Terms

Bought singly, the five volumes comprising this library would cost you more. Under this offer you save money and, in addition, have the privilege of paying in easy installments beginning with \$2.50, 10 days after receipt of the books, and \$3.00 monthly thereafter. Already these books are recognized as standard works that you are bound to require sooner or later. Take advantage of these convenient terms to add them to your library now.

SEND THIS ON APPROVAL COUPON

McGraw-Hill Book Co., Inc.
330 W. 42nd St., New York, N. Y.

Send me the McGraw-Hill Radio Engineering Library 5 vols., for 10 days' examination on approval. In 10 days I will send \$2.50, plus few cents postage, and \$3.00 monthly till \$23.50 is paid, or return books post-paid. (We pay postage on orders accompanied by remittance of first installment.)

Name

Address

City and State

Position

CompanyL. 10-40

(Books sent on approval in U. S. and Canada only.)

Radio Interference Filter

TYPE 7859 RADIO INTERFERENCE FILTER, available from J. W. Miller Co., (5917 S. Main St., Los Angeles, Cal.) is designed primarily for use with marine generators, but the filter is applicable to d-c generators and motors of all types when it is desired to avoid radio interference generated at the commutator. Parallel No. 1 B&S gage wire is used in each choke. The filter has a special section for the shunt field. The shunt field section is rated at 30 amps. Four 2 μ f non-inductive wound paper condensers are used.

Coaxial Cable Connectors

A NEW LINE OF CO-AXIAL CABLE connectors has just been introduced by the Selectar Manufacturing Corporation, 30 West 15th St., New York City, with a number of new features. Although especially designed for commercial airlines, the new connectors are also suitable for mobile and stationary installations and simplify to a great extent, the connecting of gas filled high frequency transmission lines. The connectors provide for both electrical and gaseous connections, and the elements of dependability, simplicity and weight are the primary factors. These connectors are available in various sizes ($\frac{3}{8}$, $\frac{1}{2}$, $\frac{3}{4}$ and 1 ins), types and models to accommodate transmission lines. Extensions, elbows, antenna terminals and chassis types are also available in all sizes.

Attenuator

MODEL 1658 ATTENUATOR HAS been announced by Cinema Engineering Co., 5334 Hollywood Blvd., Hollywood, Cal. Although in the lower priced bracket, this unit has 2 per cent wire wound resistors, reamed sleeve bearing and ground shaft and precision surfaced contact points embodying the same precision and careful workmanship found in the higher-priced C-E controls. The 1658 control is available as a 20 step ladder attenuator to all standard specifications. A similar unit is also available as a potentiometer control.

Communications Receiver

RADIO MANUFACTURING ENGINEERS, INC., Peoria, Ill., announce their new SPD-11 receiver for use on a number of predetermined, preset frequency channels. The receiver consists of 10 tubes, is crystal-controlled on any of five frequency channels selected from 2 to 3 Mc, it has two tuned stages of radio frequency ahead of the first detector, and incorporates a QAVC circuit for standby quietness. It has high sensitivity and image ratios. The five frequency channels may be selected by means of a selector switch. A sixth position is left blank so that with the incorporation of proper coils and crystal an additional frequency may be tuned. These units may be adapted for other ranges up to and including the u-h-f police bands.

QUALITY ABOVE ALL! SOLAR CAPACITORS



**XL
TRANSOIL**
For
Permanent
Filters

**XD, XC
TRANSOIL**
for Filters
and Bypass

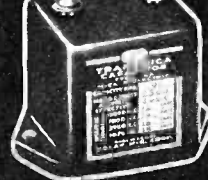
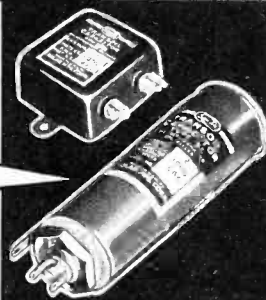

**XA, XH
MICA**
Oscillator
Tank Circuits

**XR, XS
MICA**
Tank Circuits,
R. F. Bypass

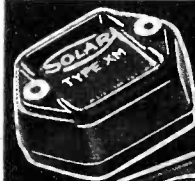
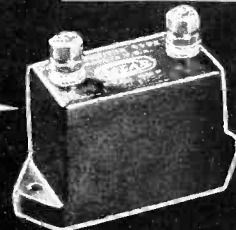

**XM, XQ
MICA**
Coupling, Blocking
R. F. Bypass



**MH, MW
MT, MO
MICA**
Low-voltage

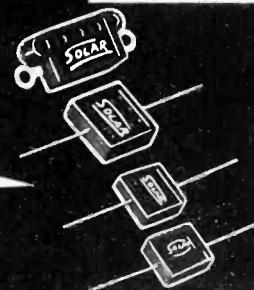

**XT
OIL
TUBULAR
S**
Wax-Molded
Paper Tubular

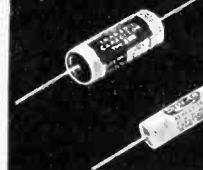

Write for
New Engineering Data Sheets
on Your Letterhead

SOLAR MFG. CORP.,
Bayonne, New Jersey

V. U. METERS

by **TRIPLET**

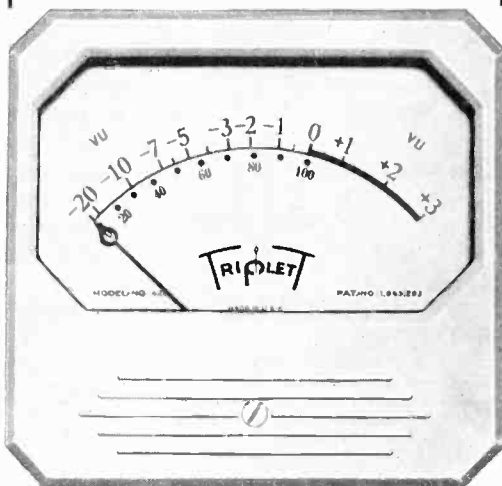

MODEL 426

FOUR INCH SQUARE CASE

Volume Unit Meters are for measurement of sound or noise levels including broadcast monitoring use with public address or communication systems, etc. Ballistic characteristics comply with specifications formulated as a result of standardization recommendations of NBC, CBS and Bell Telephone Laboratories. Steady state reference level of 1 Milliwatt. Calibrated for 600 ohm line. Has 0-100% scale and also reads minus 20 V.U. to zero level in black numerals; from zero to plus 3 V.U. in red numerals. Furnished in Model 426 modernistic case. Illuminated or non-illuminated types available.

Write for complete circular on volume level measuring instruments. Triplet manufactures electrical measuring instruments in more than 25 case styles and a complete line of radio test equipment. Literature on request. Write Section 2310, Harmon Drive.

THE TRIPLET ELECTRICAL INSTRUMENT CO.
Bluffton, Ohio

Pickups and Recording Heads

SEVERAL new pickups and recording heads have been added to the line of Webster Electric Co., Racine, Wis. Included are: R-83 Series recording heads in several impedances covering frequency range from 30 to 7,000 cycles; R-84 Series recording heads, 8 and 500 ohm impedances, 30 to 8,500 cycles; X-82 Series cartridge in several frequency ranges; and X-82A-3 crystal pickup, 30 to 8,500 cycles.

Resistance Decades

SHALLCROSS MFG. CO., COLLINGDALE, PA., announce that their new series of resistance decades contain 10 non-inductive resistors mounted on a high grade ceramic insulated rotary selector switch. This assembly in turn is mounted on an engraved bakelite panel and the whole is enclosed in a cast aluminum box. These resistance decades are available in increments from 1/10th ohm to 1,000,000 ohms.

Dynamic Microphone

A NEW, MODERN, GENERAL-PURPOSE dynamic microphone known as "Stratoliner" is announced by Shure Bros., 225 W. Huron St., Chicago. The new Series 508 is available in 35-50 ohms, 200-250 ohms, and high impedance models. Permissible cable length is practically unlimited with low impedance models. High impedance models may be used with crystal microphone amplifier and other amplifiers with input impedance of 100,000 ohms or more.

Ceramic Trimmer Capacitor

A COMPACT CERAMIC TRIMMER capacitor has been announced by Centralab, 900 E. Keefe Ave., Milwaukee, Wis. Characteristics of this capacitor are: Fixed plate bonded to the ceramic base, eliminating the usual variable air film; variable plate rotates on a ground

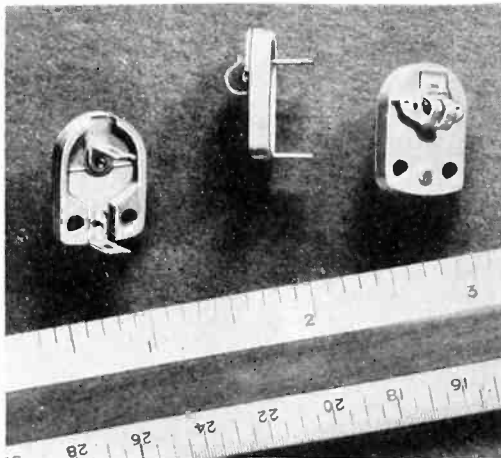

ceramic surface; equally stable at all capacity adjustments; provide negative temperature compensation of 0.0006 $\mu\mu\text{f}/\mu\mu\text{f}/^\circ\text{C}$; power factor less than 0.1 per cent; capacity change with humidity or temperature cycling less than 0.5 per cent; available capacity ranges 2 $\mu\mu\text{f}$ to 6 $\mu\mu\text{f}$, 3 $\mu\mu\text{f}$ to 12 $\mu\mu\text{f}$, 7 $\mu\mu\text{f}$ to 30 $\mu\mu\text{f}$, 60 $\mu\mu\text{f}$ to 75 $\mu\mu\text{f}$.

New Coil Bobbin

A NEW TYPE OF INEXPENSIVE ELECTRIC COIL bobbin, developed by the Precision Paper Tube Company, 2033 Charleston Street, Chicago, enables manufacturers of small motors, relays, solenoids, reactors, photoelectric devices and other electrically actuated equipment to use the smaller and more efficient bobbin coil rather than the larger layer wound coil, having an insulating strip between each winding layer. These new bobbins are made of either kraft or fish paper, or a combination of both, depending on the requirements. The paper is spirally wound on a steel die on automatic machines to form a tube of convenient length, which is cut into proper bobbin sizes. The flanges are of vulcanized fibre, die cut to the exact size and shape and pressed over the ends of the tubes. Round, square or rectangular bobbins of any size can be made with the same degree of accuracy.

Transmitters

TWO NEW TRANSMITTERS HAVE BEEN INTRODUCED BY Harvey-Wells Communications, Inc., Southbridge, Mass. The first is Type 50-TC, 50 watt ground station unit with telephone dial tuning control of circuits (10 positions), local and remote control facilities, single 500 ohm line between transmitter and remote unit (no multiple lines are necessary), vertical type chassis construction for complete accessibility and "push to talk" operation. The second transmitter is Type 100-FT, 100 watt unit for police or continuous commercial service. It features vertical chassis construction, output designed for 72 ohm coaxial line, recessed meter panel, oven-controlled crystal and "push-to-talk" operation.

Industrial Diagnostic Lights

"ANG-LITES" ARE EXPRESSLY DESIGNED to bring brilliant light at various angles to deeply recessed areas where careful inspection is necessary. These lights (manufactured by Dr. D. L. Weiss, Diagnostic Ultra-Lite Co., 170 Broadway, New York City) are fabricated from DuPont's Lucite. The light can be brought round 180 degrees into almost inaccessible places. A hooked "Ang-Lite" is available for retrieving wires, etc. These lights can be had in various stock shapes and designs or special forms can be made up to order. The handle of the Ang-Lite unit is a specially designed (Eveready) pocket pen light with a telescopic metal sleeve which shields the light source and contains interchangeable reducing bushings into which are screwed the large selection of Ang-Lites. When in operation there is approximately 50-75 candlepower of light at the point or tip, varying with the length and degree of the angle, with little or no light along the shaft.

CONTACTS

FOR THE FIELD OF ELECTRONICS



SIGNAL & INDICATOR PILOT LIGHTS

for all electrical devices.

WRITE FOR CATALOGUE showing a complete line of assemblies for all purposes.

SIGNAL INDICATOR Corp.

140 CEDAR ST. NEW YORK, N. Y.

RELAYS

AND CONTROL ACCESSORIES

- POWER
 - LATCHING
 - TELEPHONE
 - TIME DELAY
 - PLATE CIRCUIT
 - PHOTO CELLS
 - CAPACITY RELAYS
 - COUNTERS
- IN STOCK

TECHNICAL ASSISTANCE AND LAB. FACILITIES AT YOUR DISPOSAL

DOUGLAS RADIO

89 Cortlandt St. New York, N. Y.

BA. 7-3956

TOM WAITE

ROS. AMMON

REX FOUR-RANGE RHEOSTATS

The latest REX development

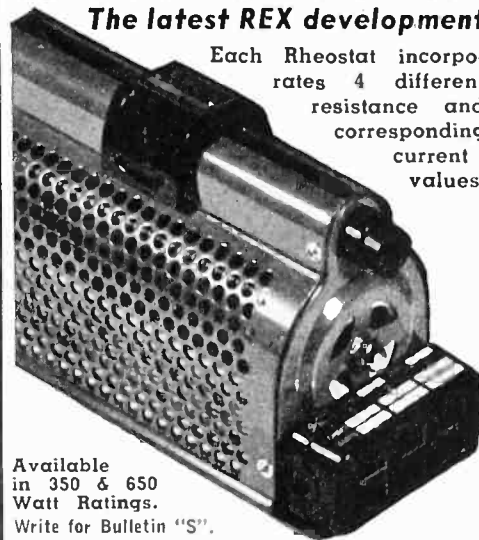

Each Rheostat incorporates 4 different resistance and corresponding current values.

Available in 350 & 650 Watt Ratings.

Write for Bulletin "S".

REX RHEOSTAT CO. 39 W. 20th St., New York, N. Y.

FINE RIBBONS of Tungsten, Molybdenum and Special Alloys

To your specifications

H. CROSS

15 BEEKMAN ST. NEW YORK

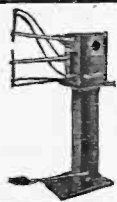

We manufacture a complete line of equipment

SPOT WELDERS, electric, from 1/4 to 500 KVA AC ARC TRANSFORMERS, special and standard types WELDERS INCANDESCENT LAMP manufacturing equipment From 100 to RADIO TUBES, ex-ray cathode ray, photo cells 400 Amps. ELECTRONIC EQUIPMENT, vacuum pumps, etc. TUNGSTEN SLUGS, rod and wire manufacturing equipment GENERAL GLASS working machines and burners COLLEGE GLASS working units for students and laboratory

EISLER ENGINEERING COMPANY, CHAS. EISLER, Pres.
751 So. 13th St. (near Avon Ave.) Newark, New Jersey

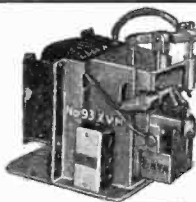

MICROMETER

for checking transmitters, from 1.5 to 56 mc., within 0.01 per cent.

LAMPKIN LABORATORIES

—Bradenton, Fla., U. S. A.—

VACUUM TUBES AND ELECTRONIC DEVICES

Design, Development and Construction of tubes and circuits.

VACUTRON, INC.

2819 12 St. South Arlington, Va.

CONSOLIDATED ENGINEERING CORPORATION

ELECTRONIC ★ OPTICAL ★ VIBRATION ENGINEERING AND RESEARCH

INSTRUMENT DEVELOPMENT AND MANUFACTURE ★ PATENT STUDIES

1255 EAST GREEN STREET. PASADENA, CALIFORNIA

A C T O N E



CUTTING STYLI

For recording direct on all coated aluminum or paper base discs. Individually lapped for a quiet, high quality cut.

H. W. ACTON CO., Inc., 370 7th Ave., New York

HERE'S HELP

for technical and business men



NEW 1940 Catalogue of McGRAW-HILL BOOKS

OVER 1500 BOOKS DESCRIBED

GET YOUR FREE COPY NOW—MAIL COUPON

Here is a guide to practical, expert information on business and technical topics. In it you will find the up-to-date books by leaders of business, industry and research that will give you the facts you need in solving your own problems.

McGraw-Hill Books bring you the experience of experts in your field

McGraw-Hill Book Co., 330 W. 42 St., N. Y. Send me a free copy of the New Catalogue of McGraw-Hill Books. I am interested in these subjects:

.....
Name
Address
City State SL 10-40

TRANSMITTING TUBE PARTS

"The Engineering Co." of Newark, N. J., Inc. SPECIALISTS IN TUNGSTEN AND MOLYB-DENUM WELDS—LEAD-IN WIRES MATERIAL AND WORKMANSHIP GUARANTEED—WE USE THE BEST ALWAYS.

59 Branford Street Newark, N. J.

D. Kondakjian, Pres. Est. 18 Years

FILTERS—EQUALIZERS

Lattice Bridged-T Paralleled-T etc. Designed and manufactured Submit your filter problem

HOLLYWOOD TRANSFORMER CO. 7364 Melrose Ave. Hollywood, Calif.

SEARCHLIGHT SECTION

EMPLOYMENT • BUSINESS • OPPORTUNITIES • EQUIPMENT—USED or RESALE

UNDISPLAYED RATE:

10 cents a word, minimum charge \$2.00.
(See ¶ on Box Numbers)

Positions Wanted (full or part-time salaried employment only), one-half the above rates.

Proposals, 50 cents a line an insertion.

NEW ADVERTISEMENTS received by 10 A.M. October 29th will appear in the November Issue, subject to limitations of space available.

INFORMATION:

Box Numbers in care of our New York, Chicago or San Francisco offices count 10 words additional in undisplayed ads.

Discount of 10% if full payment is made in advance for four consecutive insertions of undisplayed ads (not including proposals).

DISPLAYED—RATE PER INCH:

The advertising rate is \$6.00 per inch for all advertising appearing on other than a contract basis. Contract rates quoted on request.

An Advertising inch is measured 7/8 inch vertically on one column. 3 columns—30 inches—to a page.

WANTED

RADIO & MECHANICAL ENGINEERS

Engineers with two or more years radio design experience wanted. Apply stating education, experience and salary required.

COLONIAL RADIO CORP.

254 Rano St. Buffalo, N. Y.

POSITION VACANT

Splendid opportunity for first class A-1 electrical engineer with amplifying experience. Address reply with full details to P-247, Electronics, 520 N. Michigan Ave., Chicago, Ill.

POSITION WANTED

RADIO ENGINEER, executive ability, business experience, designed, constructed, installed twenty communication phone stations last five years, go anywhere, 34, married, now employed as Chief Engineer. PW-245, Electronics, 330 W. 42nd St., New York, N. Y.

WANTED

Used RCA 96A or EW 110A Limiter Amplifier, Rack type Audio Oscillator, GR Distortion Meter, Recording Equalizers and Attenuators. W-246, Electronics, 330 W. 42nd St., New York, N. Y.

HIGH GRADE USED

ELECTRON TUBE MACHINERY

Huge Stock of Every Type and Variety

KAHLE ENGINEERING CORPORATION
Specialists in Equipment for the manufacture of Neon Tubes, Radio Tubes, Incandescent Lamps, Photo Cells, X-ray Tubes, etc.

900 DeMott St., North Bergen, N. J.

DEPENDABLE

Used

ELECTRONIC TUBE EQUIPMENT

Complete line of used equipment for the manufacture of Radio Tubes, Neon Tubes, Incandescent Lamps, etc. Write for Bulletin showing 25 to 75% savings.

CALLITE TUNGSTEN CORPORATION
formerly Eisler Electric Corp.
534 39th Street, Union City, N. J.

ENGINEER WANTED

Leading parts manufacturer has opening for electro-mechanical engineer with knowledge and experience in the design of attenuators for communication systems. Position affords worthwhile opportunity. Give full details. All replies confidential. Our own organization knows of this advertisement.

P-244, c/o Electronics
330 W. 42nd Street, New York City

SOLD!

"We sold—through an answer to the ad—the item advertised in the Searchlight Section of ELECTRONICS."

Can "Searchlight" help you?

WORLD'S FAIR SURPLUS EQUIPMENT

Sound Equipment from the Electric Utilities Exhibit Corporation

The following Amplifiers were designed by Electric Utilities engineers for continuous operation with very low temperature rise. Condensers are of the plug and socket type, permitting instantaneous replacement. Amplifier Rack complete with 8—20-watt Amplifiers and two Pre-amplifiers. Enclosed steel cabinet housing eight 20-watt Amplifiers and two Pre-Amplifiers. One Pre-Amplifier has a low impulse input to match the Audak pickup, the other a high impulse input to match a crystal pickup. The eight 20-Watt Power Amplifiers and two Pre-Amplifiers are removable from the rack as described for the 30-watt Amplifiers. The 20-Watt Amplifiers have a frequency characteristic flat within two decibels to 17,000 cycles, with a distortion factor of about 1½ percent.

9—General Industries Model "H" Dual Speed Motors, extra laminations, extra heavy duty; and weighted turntables. Each are equipped with crystal pickup and repeater type tone arm for 16-inch records. The repeaters work equally well on 78-33-½, 10".

12—12", 14" and 16" records. Have adjustable counterweights for regulating the weight on needle, and either repeat a part of the record or play a given portion, go back to the starting point and hold this position until an outside impulse is given, at which time the head comes down and the record starts to play. The repeater is energized by a solenoid protected by an automatic thermal cutout. The coil is protected by the thermal unit which automatically cuts the current from the coil. Tone arms are ballbearing operated and chromium plated.

3—General Industries Record Changers with brown stipple, commercial type.

2—Special General Industries Record Changers with Model "H" Motors.

1—30-Watt Amplifier, box type, complete with rack brackets—interchangeable.

9—30-Watt Amplifiers complete with rack brackets—interchangeable. The 9—30-Watt Amplifiers match crystal pickups on the input and have a low impedance output for cone loud speakers. These amplifiers were especially built for our purpose. They are made for panel mounting and are provided with brackets which can be attached to any vertical strip or wall to create the neces-

sary mountings in lieu of a rack. Each amplifier is equipped with a multiple plug which when pushed into place engages a multiple jack. Every connection to the amplifier, panel, input, output, power connections, etc., are made through these well shielded multiple plugs, thus permitting the amplifier to be removed, repaired and replaced without breaking a single connection. Designed for continuous operation with very low temperature rise.

1—Saja Synchronous Motor, No. 20245, 78-33-½ Dual Speed, 110-220 Volts, complete with 16-inch turntable.

9—Specially constructed Automatic Chrome-finished Repeaters, complete with relays, solenoids, dash pots, protective thermal coils and pickups.

1—Frequency Modulation Tuner.

SPEAKERS

2—Cinaudagraph SU-18-12 Speakers—18-inch diaphragm

2—Cinaudagraph LM-18-80 Speakers—18-inch diaphragm

2—Cinaudagraph HW-13-13 Speakers—13-inch diaphragm

2—Cinaudagraph HY-12-12 Speakers—12-inch diaphragm

5—Cinaudagraph FY-12-12 Speakers—12-inch diaphragm

1—Cinaudagraph NZ-10-10 Speakers—10-inch diaphragm

14—Cinaudagraph EZ- 8-10 Speakers—8-inch diaphragm

1—Cinaudagraph CA- 5- 8 Speakers— 5-inch diaphragm

1—Cinaudagraph TA- 5- 8 Speakers— 5-inch diaphragm

WRITE—WIRE OR PHONE CLAYTON IRWIN

Electric Utilities Exhibit Corp.

World's Fair, N. Y.

Tel—HAvemeyer 6-2200

Prepare to pass RADIO OPERATOR LICENSE EXAMINATIONS

this direct easy way

Bring all your radio training, experience, and study before you in quick, direct review—make sure you know key points of all theory and practice as covered in Government examinations. Nearly 1300 questions, with full, correct answers, given in this book, make you confidently familiar with the essentials of all commercial license tests.

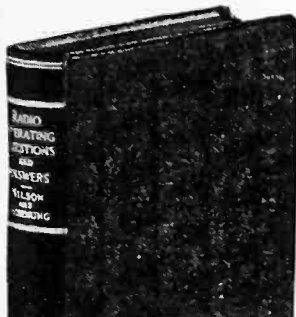

Just Out

New 7th Edition

RADIO OPERATING QUESTIONS and ANSWERS

By Arthur R. Nilson

Chief Instructor, Nilson Radio School; Lieut. (Technician) (Communications) U.S.N.R. (Retired)

and J. L. Hornung

Formerly Radio Instructor, New York University

400 pages, 5 x 7½, illustrated, \$2.50

This is a technical review book on radio communication for prospective and experienced radio operators of all classes, condensing in question and answer form all the information covered in the new type of Government radio operator license examinations. It provides an answer to each question appearing in the FCC Publication, *Study Guide and Reference Material for Commercial Radio Operator License Examinations*, and is arranged according to the six elements upon which examinations for all grades of licenses are now based:

1. Questions on Basic Law
2. Basic Theory and Practice
3. Radiotelephony
4. Advanced Radiotelephony
5. Radiotelegraphy
6. Advanced Radiotelegraphy

Appendix of operating abbreviations, rules governing commercial operators, and radio laws

For twenty years thousands of men have used previous editions of this book with success. Now more than ever this seventh edition helps you get a quick command of all the information needed to pass tests.

Mail this coupon for
10 DAYS' FREE EXAMINATION

McGraw-Hill Book Co., Inc., 330 W. 42nd St., N. Y.

Send me Nilson and Hornung's Radio Operating Questions and Answers for 10 days' examination on approval. In 10 days I will send \$2.50 plus few cents postage, or return book postpaid. (Postage paid on orders accompanied by remittance.)

Name

Address

City and State

Position

Company L-10-40

(Books sent on approval in U. S. and Canada only.)

Speech Input Equipment

A NEW LINE OF SPEECH INPUT EQUIPMENT, custom-built to meet the individual needs of broadcasting stations or motion picture studios, regardless of size or operating requirements, has been announced by the Western Electric Company, 195 Broadway, New York City. The new equipment achieves flexibility of function by employing the principle of unit construction in both its electrical and mechanical aspects. This input equipment has been designed, constructed and tested as a complete audio frequency system for radio broadcasting, conforming to F.C.C. *Standards of Good Engineering Practice* for both standard and high-frequency broadcast stations. Additional features are: Ease of installation; one compactly assembled and wired unit with all incoming connections except a-c supply made at small terminal panel at the end of a desk; ease of operation: number of controls reduced to fundamental requirements and all in convenient reach of the operator; ease of maintenance and inspection; utmost accessibility to all apparatus and wiring.

Multi-range Ammeter

A NEW MULTI-RANGE "CLIP-ON" AMMETER is available from Ferranti Electric, Inc., 30 Rockefeller Plaza, New York City. This new instrument reads from 0 to 1,000 amps, having five full scales of 0-10/25/100/250/1000 amps. There is only one single, simple

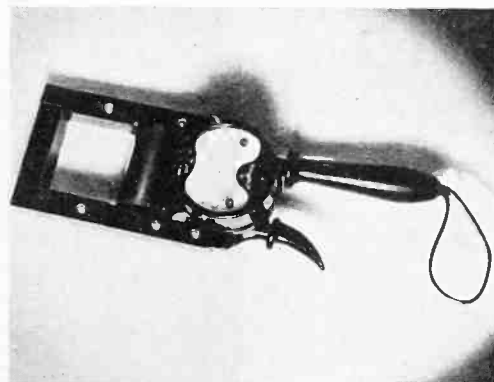

set of scale divisions and all full scales are multiples of 10 or 25. The meter is well balanced, easy to operate, and has clamping jaws which are insulated. The instrument has a rectangular opening which makes it adaptable for use on square busbars as well as round cables.

Blower System

A DEVICE KNOWN AS TYPE 400-A BLOWER SYSTEM has been developed by Presto Recording Corp., 24 West 55th St., New York City, for cleaning the surface of a disc while recording and disposing of the shavings cut from the disc so that they cannot tangle under the cutting needle. This system is an improvement over the vacuum systems in that the airstream is kept away from the cutting needle where it cannot produce air noise in high fidelity recordings. It is quiet in operation.

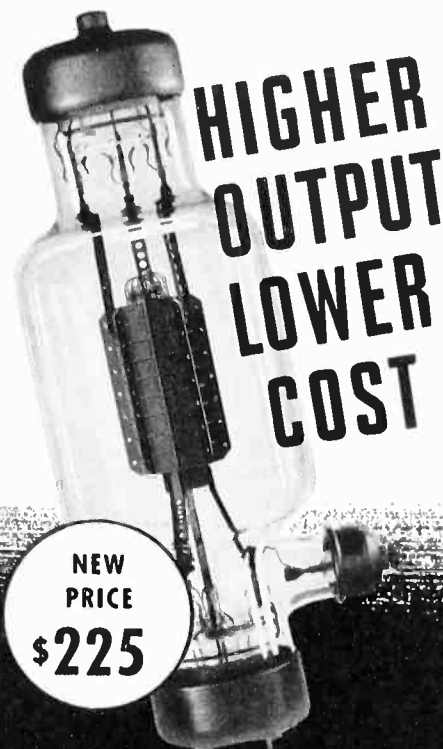

**HIGHER
OUTPUT
LOWER
COST**

NEW
PRICE
\$225

With the improved type
1554 GAMMATRON
plate dissipation—1000 watts

WRITE FOR DATA

HEINTZ AND KAUFMAN
SOUTH SAN FRANCISCO LTD. CALIFORNIA U.S.A.

MIDGET "MEGGER" CIRCUIT TESTING OHMMETER

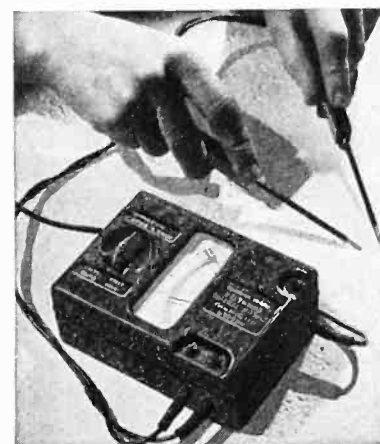

Independent of Battery Voltage
Ranges—from .1 ohm up to 200,000 ohms

Quite different from a voltmeter calibrated in ohms, this direct-indicating "Megger" Ohmmeter requires no adjustment for the voltage of the battery that supplies current for the test. The instrument is a true ohmmeter of the "Megger" cross-coil type. For laboratory, shop and portable use for checking coils, resistors, contacts, windings, circuits, relays, etc., and even insulation resistance up to 200,000 ohms. Molded case, mottled green in color. Write for descriptive Bulletin 1495-E.

JAMES G. BIDDLE CO.

ELECTRICAL INSTRUMENTS

1211-13 ARCH STREET PHILADELPHIA, PA.